

Aspire 8943G Series Service Guide

Service guide files and updates are available on the ACER/CSD web; for more information, please refer to <http://csd.acer.com.tw>

Revision History

Please refer to the table below for the updates made on this service guide.

Date	Chapter	Updates

Copyright

Copyright © 2010 by Acer Incorporated. All rights reserved. No part of this publication may be reproduced, transmitted, transcribed, stored in a retrieval system, or translated into any language or computer language, in any form or by any means, electronic, mechanical, magnetic, optical, chemical, manual or otherwise, without the prior written permission of Acer Incorporated.

Disclaimer

The information in this guide is subject to change without notice.

Acer Incorporated makes no representations or warranties, either expressed or implied, with respect to the contents hereof and specifically disclaims any warranties of merchantability or fitness for any particular purpose. Any Acer Incorporated software described in this manual is sold or licensed "as is". Should the programs prove defective following their purchase, the buyer (and not Acer Incorporated, its distributor, or its dealer) assumes the entire cost of all necessary servicing, repair, and any incidental or consequential damages resulting from any defect in the software.

Acer is a registered trademark of Acer Corporation.

Intel is a registered trademark of Intel Corporation.

Other brand and product names are trademarks and/or registered trademarks of their respective holders.

Conventions

The following conventions are used in this manual:

SCREEN MESSAGES	Denotes actual messages that appear on screen.
NOTE	Gives bits and pieces of additional information related to the current topic.
WARNING	Alerts you to any damage that might result from doing or not doing specific actions.
CAUTION	Gives precautionary measures to avoid possible hardware or software problems.
IMPORTANT	Reminds you to do specific actions relevant to the accomplishment of procedures.



NOTE: This symbol where placed in the Service Guide designates a component that should be recycled according to the local regulations.

Preface

Before using this information and the product it supports, please read the following general information.

1. This Service Guide provides you with all technical information relating to the BASIC CONFIGURATION decided for Acer's "global" product offering. To better fit local market requirements and enhance product competitiveness, your regional office MAY have decided to extend the functionality of a machine (e.g. add-on card, modem, or extra memory capability). These LOCALIZED FEATURES will NOT be covered in this generic service guide. In such cases, please contact your regional offices or the responsible personnel/channel to provide you with further technical details.
2. Please note WHEN ORDERING FRU PARTS, that you should check the most up-to-date information available on your regional web or channel. If, for whatever reason, a part number change is made, it will not be noted in the printed Service Guide. For ACER-AUTHORIZED SERVICE PROVIDERS, your Acer office may have a DIFFERENT part number code to those given in the FRU list of this printed Service Guide. You MUST use the list provided by your regional Acer office to order FRU parts for repair and service of customer machines.

System Specifications	1
Features	1
System Block Diagram	6
Notebook Tour	7
Top View	7
Closed Front View	8
Left View	9
Right View	10
Base View	10
Indicators	11
TouchPad Basics	12
Using the Keyboard	13
Lock Keys and embedded numeric keypad	13
Windows Keys	14
Hot Keys	15
Special Keys	16
Hardware Specifications and Configurations	17
 System Utilities	 31
BIOS Setup Utility	31
Navigating the BIOS Utility	31
Information	32
Main	33
Security	34
Boot	37
Exit	38
BIOS Flash Utility	39
DOS Flash Utility	39
WinFlash Utility	40
Remove HDD/BIOS Password Utilities	41
Removing BIOS Passwords:	42
Miscellaneous Utilities	43
 Machine Disassembly and Replacement	 45
Disassembly Requirements	45
Related Information	45
Replacement Requirements	45
Pre-disassembly Instructions	46
Disassembly Process	47
External Module Disassembly Process	48
External Modules Disassembly Flowchart	48
Removing the Battery Pack	50
Removing the Dummy Card	51
Removing the Base Door	52
Removing the Hard Disk Drive Module	53
Removing the DIMM Module	55
Removing the WLAN Module	56
Removing the TV Tuner Module	57
Removing the Slave HDD Module	59
Removing the ODD Module	61
Removing the Keyboard	63
Main Unit Disassembly Process	65
Main Unit Disassembly Flowchart	65
Removing the Upper Cover and LCD Module	66

Table of Contents

Removing the Microphone Cable	71
Removing the Bluetooth Module	72
Removing the Mainboard to Touchpad Cable	74
Removing the Touchpad Module	75
Removing the Finger Print Board	77
Removing the LAN Board	79
Removing the USB Board	81
Removing the Mainboard	84
Removing the RTC Battery	86
Removing the Thermal Module	86
Removing the CPU	88
Removing the PCH Heatsink	89
Removing the Subwoofer and Back Speaker	90
Removing the TV Tuner Cable Assembly	93
Removing the DC-In Cable Assembly	94
Removing the Front Speakers	95
LCD Module Disassembly Process	98
LCD Module Disassembly Flowchart	98
Removing the LCD Hinge Bezel	99
Removing the LCD Bezel	101
Removing the Camera Board	103
Removing the LCD Panel	104
Removing the Arcade Board	107
Removing the Power Board	109
LCD Reassembly Procedure	111
Replacing the Power Board	111
Replacing the Arcade Board	113
Replacing the LCD Panel	114
Replacing the Camera Board	118
Replacing the LCD Bezel	118
Replacing the LCD Hinge Bezel	120
Main Unit Reassembly Process	122
Replacing the Front Speakers	122
Replacing the DC-In Cable Assembly	125
Replacing the TV Tuner Cable Assembly	126
Replacing the Subwoofer and Back Speaker	127
Replacing the PCH Heatsink	131
Replacing the CPU	132
Replacing the Thermal Module	133
Replacing the RTC Battery	135
Replacing the Mainboard	135
Replacing the USB Board	138
Replacing the LAN Board	140
Replacing the Finger Print Board	142
Replacing the Touchpad Board	144
Replacing the Mainboard to Touchpad Cable	146
Replacing the Bluetooth Module	148
Replacing the Microphone Cable	150
Replacing the Upper Cover and LCD Module	151
Replacing the Keyboard	157
Replacing the ODD Module	159
Replacing the Slave HDD Module	161
Replacing the TV Tuner Module	164
Replacing the Wireless LAN Module	165
Replacing the DIMM Module	166

Table of Contents

Replacing the Hard Disk Drive	167
Replacing the Base Door	169
Replacing the Dummy Card	169
Replacing the Battery	170
Troubleshooting	171
Common Problems	171
Power On Issue	172
No Display Issue	173
Random Loss of BIOS Settings	174
LCD Failure	175
Built-In Keyboard Failure	176
TouchPad Failure	177
Internal Speaker Failure	178
Internal Microphone Failure	179
HDD Not Operating Correctly	180
USB Failure (Right up/down side)	181
Other Failures	181
Intermittent Problems	182
Undetermined Problems	182
Post Code Reference Tables	183
Jumper and Connector Locations	189
Mainboard Top View	189
Mainboard Bottom View	190
Clearing Password Check and BIOS Recovery	191
Mainboard CMOS Discharge	191
BIOS Recovery by Crisis Disk	192
FRU (Field Replaceable Unit) List	193
Exploded Diagrams	193
Main Assembly	193
LCD Assembly	194
FRU List	195
Screw Table	207
Model Definition and Configuration	209
Aspire 8943G	209
Test Compatible Components	343
Online Support Information	349

Table of Contents

System Specifications

Features

Below is a brief summary of the computer's many features:

Operating System

- Genuine Windows® 7 Home Basic 64-bit
- Genuine Windows® 7 Home Premium 64-bit

Platform

- Intel® Core™ i7-820QM processor (8 MB L3 cache, 1.73 GHz with Turbo Boost up to 3.06 GHz, DDR3 1333 MHz, 45 W), i7-720QM processor (6 MB L3 cache, 1.60 GHz with Turbo Boost up to 2.80 GHz, DDR3 1333 MHz, 45 W), supporting Intel® 64 architecture, Intel® Smart Cache
- Intel® Core™ i7-620M processor (4 MB L3 cache, 2.66 GHz with Turbo Boost up to 3.33 GHz, DDR3 1066 MHz, 35 W), supporting Intel® 64 architecture, Intel® Smart Cache
- Intel® Core™ i5-430M/i5-520M/i5-540M processor (3 MB L3 cache, 2.26/2.40/2.53 GHz with Turbo Boost up to 2.53/2.93/3.06 GHz, DDR3 1066 MHz, 35 W), supporting Intel® 64 architecture, Intel® Smart Cache
- Intel® Core™ i3-330M/i3-350M processor (3 MB L3 cache, 2.26 GHz, DDR3 1066 MHz, 35 W), supporting Intel® 64 architecture, Intel® Smart Cache
- Mobile Intel® HM55 Express Chipset

System Memory

- Dual-channel DDR3 SDRAM support:
 - Up to 4 GB of DDR3 system memory, upgradable to 16 GB using four soDIMM modules⁵ (only for models with Intel® Core™ i7-820QM/i7-720QM processor)
 - Up to 4 GB of DDR3 system memory, upgradable to 8 GB using two soDIMM modules⁵ (only for models with Intel® Core™ i7-620M, i5-430M/i5-520M/i5-540M, or i3-330M/i3-350M processor)

Display

- 18.4" Full HD 1920 x 1080 pixel resolution, high-brightness (220-nit) Acer CineCrystal™ LED-backlit TFT LCD
- Mercury free, environment friendly
- 8 ms response time
- 60% color gamut
- Frameless design
- 16:9 aspect ratio

TV Tuner

- Digital TV-tuner supporting DVB-T (Digital Video Broadcasting-Terrestrial) standard (6 to 8 MHz)
- I/O:
 - RF-in jack for digital TV antenna cable input
- Connectors:
 - PAL/SECAM-to-RF
 - NTSC-to-PAL/SECAM
- DVB-T antenna (UHF/VHF reception)
- Remote control

Graphics

- ATI Mobility Radeon™ HD 5850 with 1024 MB of dedicated DDR3 VRAM, supporting Unified Video Decoder (UVD), OpenEXR High Dynamic-Range (HDR) technology, Shader Model 5.0, Microsoft® DirectX® 11, OpenGL® 3.1, OpenCL™ 1.1
- ATI Mobility Radeon™ HD 5650 with 1024 MB of dedicated DDR3 VRAM, supporting Unified Video Decoder (UVD), OpenEXR High Dynamic-Range (HDR) technology, Shader Model 5.0, Microsoft® DirectX® 11, OpenGL® 3.1, OpenCL™ 1.1
- Dual independent display support
- 16.7 million colors
- External resolution / refresh rates:
 - VGA port up to 2048 x 1536: 85 Hz
 - HDMI™ port up to 1920 x 1080: 60 Hz
- MPEG-2/DVD decodingVC-1 and H.264 (AVC) decodingMicrosoft® DirectX® Video Acceleration (DXVA) application interface (API)
- HDMI™ (High-Definition Multimedia Interface) with HDCP (High-bandwidth Digital Content Protection) support

Audio subsystem

- Dolby® 7-optimized Acer CineSurround sound system with five built-in speakers and one subwoofer supporting low-frequency effects
- Optimized 3rd Generation Dolby® Home Theater®7 audio enhancement, featuring Dolby® Digital Live, Dolby® Pro Logic® IIx, Dolby® Headphone, Dolby® Natural Bass, Dolby® Sound Space Expander, Dolby® Inverse Filtering, Dolby® High Frequency Enhancer technologies
- True 5.1-channel surround sound output
- High-definition audio support
- S/PDIF (Sony/Philips Digital Interface) support for digital speakers
- MS-Sound compatible
- Acer PureZone technology with two built-in stereo microphones, featuring beam forming, echo cancellation, and noise suppression technologies

Storage subsystem

- Hard disk drive:
 - One or two 160/250/320/500/640 GB or larger
- Multi-in-1 card reader, supporting:
 - Secure Digital™ (SD), MultiMediaCard™ (MMC), Memory Stick™ (MS), Memory Stick PRO™ (MS PRO), xD-Picture Card™ (xD)

Optical Media Drive

- 4X Blu-ray Disc™ Writer / DVD-Super Multi double-layer drive:
 - Read: 24X CD-ROM, 24X CD-R, 24X CD-RW, 8X DVD-ROM, 8X DVD-R, 8X DVD+R, 8X DVD-ROM DL, 6X DVD-R DL, 6X DVD+R DL, 8X DVD-RW, 8X DVD+RW, 5X DVD-RAM, 4X BD-ROM, 4X BD-R, 2X BD-RE, 4X BD-ROM DL, 4X BD-R DL, 2X BD-RE DL
 - Write: 24X CD-R, 16X CD-RW, 8X DVD-R, 8X DVD+R, 6X DVD-RW, 6X DVD+RW, 5X DVD-RAM, 4X DVD+R DL, 4X DVD-R DL, 4X BD-R, 2X BD-RE, 4X BD-R DL, 2X BD-RE DL
- 4X Blu-ray Disc™ / DVD-Super Multi double-layer drive:
 - Read: 24X CD-ROM, 24X CD-R, 24X CD-RW, 8X DVD-ROM, 8X DVD-R, 8X DVD+R, 8X DVD-ROM DL, 6X DVD-R DL, 6X DVD+R DL, 8X DVD-RW, 8X DVD+RW, 5X DVD-RAM, 4X BD-ROM, 4X BD-R, 2X BD-RE, 4X BD-ROM DL, 4X BD-R DL, 2X BD-RE DL
 - Write: 24X CD-R, 16X CD-RW, 8X DVD-R, 8X DVD+R, 6X DVD-RW, 6X DVD+RW, 5X DVD-RAM, 4X DVD+R DL, 4X DVD-R DL
- 8X DVD-Super Multi double-layer drive:
 - Read: 24X CD-ROM, 24X CD-R, 24X CD-RW, 8X DVD-ROM, 8X DVD-R, 8X DVD+R, 6X DVD-ROM DL, 6X DVD-R DL, 6X DVD+R DL, 6X DVD-RW, 6X DVD+RW, 5X DVD-RAM
 - Write: 24X CD-R, 16X CD-RW, 8X DVD-R, 8X DVD+R, 4X DVD-R DL, 4X DVD+R DL, 6X DVD-RW, 8X DVD+RW, 5X DVD-RAM

Communication

- Webcam:
- Acer Video Conference, featuring:
 - Acer Crystal Eye high-def webcam with 1280 x 1024 resolution
 - Acer Video Conference Manager software, featuring Video Quality Enhancement (VQE) technology, supporting 640 x 480 resolution online video calls
 - Acer PureZone technology
- Wireless and networking:
- WLAN:
 - Intel® Centrino® Wireless-N 1000 b/g/n Wi-Fi CERTIFIED™ with Acer Nplify™, featuring MIMO technology (only for models with Intel® Core™ i7-820QM/i7-720QM processor)
 - Acer InviLink™ Nplify™ 802.11b/g/n Wi-Fi CERTIFIED™ Acer InviLink™ 802.11b/g Wi-Fi CERTIFIED™
 - Supporting Acer SignalUp™ wireless technology
- WPAN1:Bluetooth® 2.1+EDR
- LAN: Gigabit Ethernet, Wake-on-LAN ready

Privacy control

- Acer Bio-Protection fingerprint solution, featuring Windows® logon, computer protection, Acer FingerLaunch, ProfileLaunch, MusicLaunch, Password Bank, MyLaunch, FingerNav
- BIOS user, supervisor, HDD passwords
- Kensington lock slot

Dimensions and Weight

- 440 (W) x 295 (D) x 31/43.8 (H) mm (17.34 x 11.62 x 1.22/1.73 inches)
- 4.6 kg (10.1 lbs.)¹⁴ with 8-cell battery

Power Adapter and Battery

- ACPI 3.0 CPU power management standard: supports Standby and Hibernation power-saving modes
- 3-pin 120 W AC adapter (only for models with Intel® Core™ i7-820QM/i7-720QM processor)
 - 155 (W) x 67 (D) x 36.5 (H) mm (6.1 x 2.63 x 1.43 inches)
 - 570 g (1.25 lbs.)¹⁴ with 180 cm DC cable
- 3-pin 90 W AC adapter:
 - 133 (W) x 59 (D) x 31 (H) mm (5.23 x 2.32 x 1.22 inches)
 - 390 g (0.86 lbs.)¹⁴ with 180 cm DC cable
- Acer QuicCharge™ technology:
 - 80% charge in 1 hour
 - 2-hour rapid charge system-off
- 71 W 4800 mAh 8-cell Li-ion standard battery pack
- Estimated battery life: Up to 3 hours
- ENERGY STAR®

Special Keys and Controls

- 103-/104-/107-key keyboard, with inverted "T" cursor layout
- Multi-gesture touchpad, supporting two-finger scroll, pinch, rotate, flip
- Acer Bio-Protection fingerprint reader, featuring Acer FingerNav 4-way control function
- 10 function keys, four cursor keys, two Windows® keys, hotkey controls, independent numeric keypad, international language support
- Acer PowerSmart key
- Easy-launch keys: Acer Backup and Programmable¹, WLAN, Bluetooth®
- Acer MediaTouch capacitive human interface device, including:
 - Acer Arcade™
 - Volume meter (volume up/down)
 - Media control (play/pause, stop, previous, next)
 - Mute and hold keys
- Acer Media Center remote control

I/O Ports

- Acer Bio-Protection fingerprint reader
- Multi-in-1 card reader (SD™, MMC, MS, MS PRO, xD)
- Five USB 2.0 ports
- eSATA port
- IEEE 1394 port
- HDMI™ port with HDCP support
- Consumer infrared (CIR) port
- External display (VGA) port
- Headphone/speaker/line-out jack with S/PDIF support
- Microphone-in jack
- Line-in jack
- Ethernet (RJ-45) port
- DC-in jack for AC adapter

Optional Items

- Acer Media Center remote control
- 2 GB / 4 GB DDR3 1066 MHz soDIMM module
- 8-cell Li-ion battery pack
- 3-pin 120 W AC adapter
- External USB floppy disk drive

Warranty

- One-year International Travelers Warranty (ITW)

Environment

- Temperature:
 - Operating: 5°C to 35°C
 - Non-operating: -20°C to 65°C
- Humidity (non-condensing):
 - Operating: 20% to 80%
 - Non-operating: 20% to 80%

NOTE: The specifications listed above are for reference only. The exact configuration of the PC depends on the model purchased.

System Block Diagram

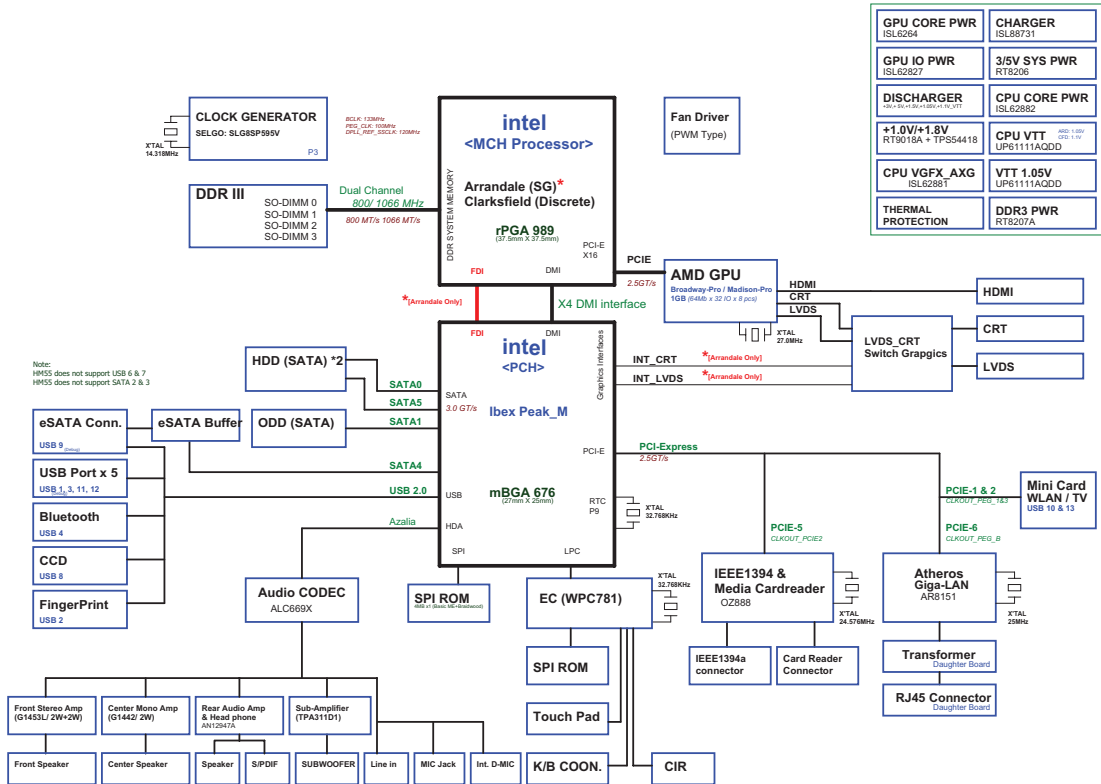







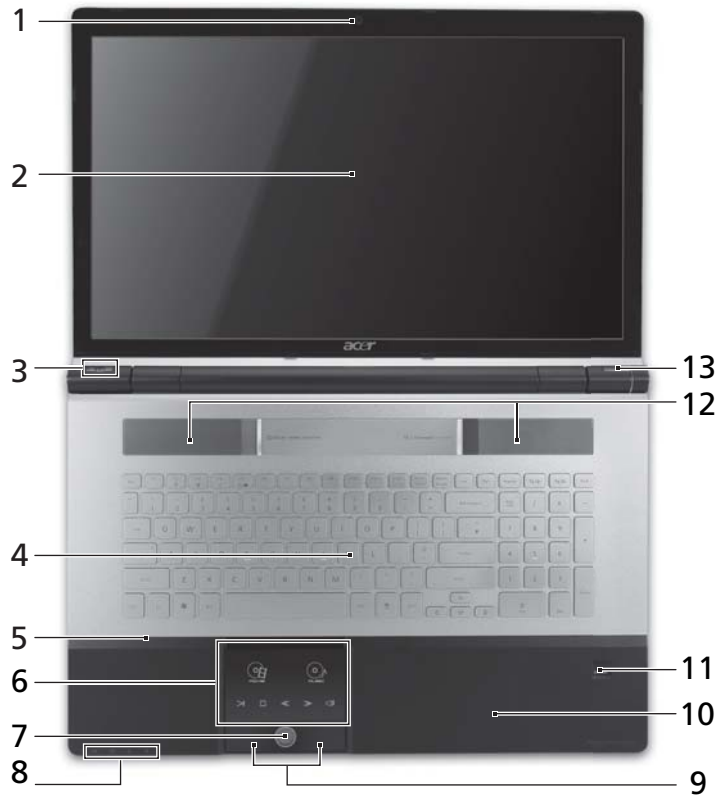







Notebook Tour

This section provides an overview of the features and functions of the notebook.

Top View



#	Icon	Item	Description
1		Acer Crystal Eye webcam	Web camera for video communication. (only for certain models)
2		Display screen	Also called Liquid-Crystal Display (LCD), displays computer output (configuration may vary by model).
3		Arcade key	Launches InstantOn Arcade.
	P	P key / Acer PowerSmart key	Programmable key (configuration may vary by model). / Puts your computer into power-saving mode (configuration may vary by model).
4		Keyboard	For entering data into your computer
5		Microphone	Internal microphone for recording sound.

#	Icon	Item	Description
6		Touchpad/Media Console	Touch-sensitive pointing device which functions like a computer mouse*. / Touch sensitive controls for Acer Arcade, volume (up/down) and media (play/pause, stop, previous, next); with mute.
		Movie	Launch movie playback software.
		Music	Launch music playback software.
		Play/pause	Play or pause a selected media file.
		Stop	Stop playing the selected media file.
		Previous	Return to the previous media file.
		Next	Jump to the next media file.
		Mute	Turn the volume on or off.
		*Touchpad becomes inactive when Media Console is active.	
7		Media Console controller	Turns Media Console on or off.
8		Communication key	Enables/disables the computer's communication devices. (Communication devices may vary by configuration.)
		Backup key	Launches Acer Backup Management for three-step data backup.
		HDD indicator	Indicates when the hard disk drive is active.
		Power indicator	Indicates the computer's power status.
9		Click buttons (left, and right)	The left and right buttons function like the left and right mouse buttons.
10		Palmrest	Comfortable support area for your hand when using the computer.
11		Acer Bio-Protection fingerprint reader	Supports Acer FingerNav 4-way control function (only for certain models).
12		Speakers	Left and right speakers deliver stereo audio output.
13		Power button/	Turns the computer on and off.

Closed Front View







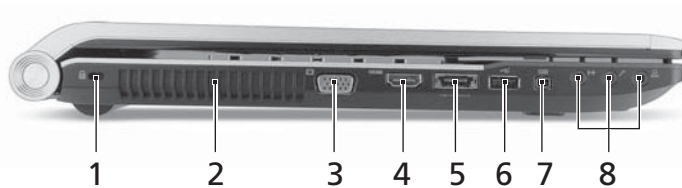

#	Icon	Item	Description
1		Thumbwheel	Turn the volume up or down.

#	Icon	Item	Description
2		Multi-in-1 card reader	Accepts Secure Digital (SD), MultiMediaCard (MMC), Memory Stick (MS), Memory Stick PRO (MS PRO), xD-Picture Card (xD). Note: Push to remove/install the card. Only one card can operate at any given time.
3		CIR receiver	Receives signals from a remote control.





Left View

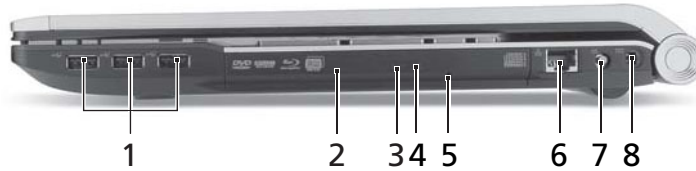

#	Icon	Item	Description
1		Kensington lock slot	Connects to a Kensington-compatible computer security lock. Note: Wrap the computer security lock cable around an immovable object such as a table or handle of a locked drawer. Insert the lock into the notch and turn the key to secure the lock. Some keyless models are also available.
2		Ventilation slots	Enable the computer to stay cool, even after prolonged use.
3		External display (VGA) port	Connects to a display device (e.g. external, LCD monitor, LCD projector).
4	HDMI	HDMI port	Supports high definition digital video connections.
5		USB 2.0 / eSATA port	Connects to USB 2.0 or eSATA devices (only for certain models). Note: If you plug an eSATA device you will have three USB ports available in the meantime.
6		USB 2.0 port	Connects to USB 2.0 devices (e.g., USB mouse, USB camera).
7		4-pin IEEE 1394 port	Connects to IEEE 1394 devices.
8		Line-in jack	Accepts audio line-in devices (e.g., audio CD player, stereo walkman, mp3 player)
		Microphone jack	Accepts inputs from external microphones.
		Headphones/speaker/line-out jack with S/PDIF support.	Connects to audio line-out devices (e.g., speakers, headphones).



Right View



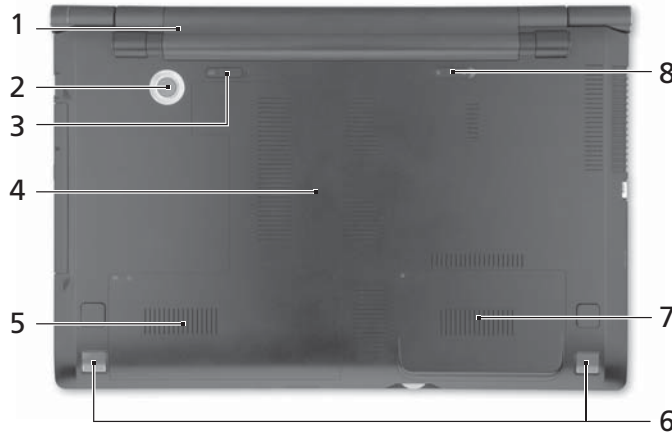

#	Icon	Item	Description
1		USB 2.0 port	Connects to USB 2.0 devices (e.g., USB mouse, USB camera).
2		Optical drive	Internal optical drive; accepts CDs or DVDs.
3		Optical disk access indicator	Lights up when the optical drive is active.
4		Optical drive eject button	Ejects the optical disk from the drive.
5		Emergency eject hole	Ejects the optical drive tray when the computer is turned off. Note: Insert a paper clip to the emergency eject hole to eject the optical drive tray when the computer is off.
6		Ethernet (RJ-45) port	Connects to an Ethernet 10/100/1000-based network.
7		RF-in port	Accepts input signals from digital TV-tuner devices.
8		DC-in jack	Connects to an AC adapter.

Base View







#	Icon	Item	Description
1		Battery bay	Houses the computer's battery pack. Note: The battery shown is for reference only. Your PC may have a different battery depending on the model purchased.
2		Subwoofer	Emits low frequency sound output.
3		Battery release latch	Releases the battery for removal.
4		Memory compartment	Houses the computer's main memory.

#	Icon	Item	Description
5		Hard disk bay- Main	Houses the computer's hard disk (secured with screws)
6		Speakers	Left and right speakers deliver stereo audio output.
7		Hard disk bay- Secondary	Houses the computer's hard disk (secured with screws) (for certain models only)
8		Battery lock	Locks the battery in position

Indicators

The computer has several easy-to-read status indicators. The following indicators are visible even when the computer cover is closed.

Icon	Function	Description
	Communication key	Enables/disables the computer's communication devices. (Communication devices may vary by configuration.)
	Backup key	Launches Acer Backup Management for three-step data backup.
	HDD indicator	Indicates when the hard disk drive is active.
	Power	Indicates the computer is on or off.

TouchPad Basics

The following items show you how to use the TouchPad:

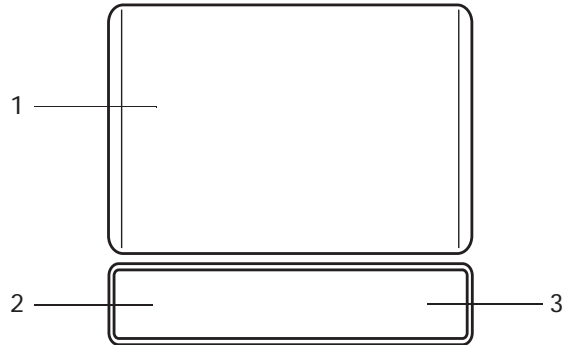

- Move your finger across the TouchPad (1) to move the cursor.
- Press the left (2) and right (3) buttons located beneath the TouchPad to perform selection and execution functions. These two buttons are the equivalent of the left and right buttons on a mouse. Tapping on the TouchPad is the same as clicking the left button.

Function	Left Button (2)	Right Button (3)	Main TouchPad (1)
Execute	Quickly click twice.		Tap twice (at the same speed as double-clicking a mouse button).
Select	Click once.		Tap once.
Drag	Click and hold, then use finger on the TouchPad to drag the cursor.		Tap twice (at the same speed as double-clicking a mouse button); rest your finger on the TouchPad on the second tap and drag the cursor.
Access context menu		Click once.	

NOTE: When using the TouchPad, keep it - and your fingers - dry and clean. The TouchPad is sensitive to finger movement; hence, the lighter the touch, the better the response. Tapping too hard will not increase the TouchPad's responsiveness.

Using the Keyboard

Your copmputer has a close-to-full-sized keyboard and an embedded numeric keypad, separate cursor, lock, function and special keys.



Lock Keys and embedded numeric keypad

The keyboard has three lock keys which you can toggle on and off.













Lock key	Description
Caps Lock	When Caps Lock is on, all alphabetic characters typed are in uppercase.
Num Lock	When Num Lock is on, the embedded keypad is in numeric mode. The keys function as a calculator (complete with the arithmetic operators +, -, *, and /). Use this mode when you need to do a lot of numeric data entry. A better solution would be to connect an external keypad.
Scroll Lock <Fn> + <F12>	When Scroll Lock is on, the screen moves one line up or down when you press the up or down arrow keys respectively. Scroll Lock does not work with some applications.

The embedded numeric keypad functions like a desktop numeric keypad. It is indicated by small characters located on the upper right corner of the keycaps. To simplify the keyboard legend, cursor-control key symbols are not printed on the keys.

Desired access	Num Lock on	Num Lock off
Number keys on embedded keypad	Type numbers in a normal manner.	
Cursor-control keys on embedded keypad	Hold <Shift> while using cursor-control keys.	Hold <Fn> while using cursor-control keys.
Main keyboard keys	Hold <Fn> while typing letters on embedded keypad.	Type the letters in a normal manner.

Windows Keys

The keyboard has two keys that perform Windows-specific functions.







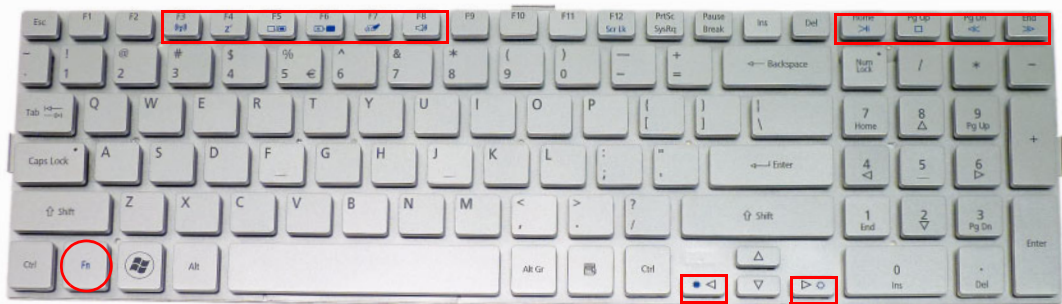





Key	Description
 Windows key	<p>Pressed alone, this key has the same effect as clicking on the Windows Start button; it launches the Start menu. It can also be used with other keys to provide a variety of functions:</p> <ul style="list-style-type: none"><  >: Open or close the Start menu<  > + <D>: Display the desktop<  > + <E>: Open Windows Explore<  > + <F>: Search for a file or folder<  > + <L>: Lock your computer (if you are connected to a network domain), or switch users (if you're not connected to a network domain)<  > + <M>: Minimizes all windows<  > + <R>: Open the Run dialog box<  > + <U>: Open Ease of Access Center<  > + <BREAK>: Display the System Properties dialog box<  > + <TAB>: Cycle through programs on the taskbar<CTRL> + <  > + <F>: Search for computers (if you are on a network) <p>Note: Depending on your edition of Windows 7, some shortcuts may not function as described.</p>
 Application key	This key has the same effect as clicking the right mouse button; it opens the application's context menu.

Hot Keys

The computer employs hotkeys or key combinations to access most of the computer's controls like screen brightness and volume output.



To activate hotkeys, press and hold the **<Fn>** key before pressing the other key in the hotkey combination.

Hotkey	Icon	Function	Description
<Fn> + <F3>		Communication switch	Enables/disables the computer's communication devices. (Communication devices may vary by configuration.)
<Fn> + <F4>		Sleep	Puts the computer in Sleep mode.
<Fn> + <F5>		Display toggle	Switches display output between the display screen, external monitor (if connected) and both.
<Fn> + <F6>		Screen blank	Turns the display screen backlight off to save power. Press any key to return.
<Fn> + <F7>		Touchpad toggle	Turns the touchpad on and off.
<Fn> + <F8>		Speaker toggle	Turns the speakers on and off.
<Fn> + <D>		Brightness up	Increases the screen brightness.
<Fn> + <Q>		Brightness down	Decreases the screen brightness.
<Fn> + <Home>		Play/Pause	Plays or pauses media files
<Fn> + <Pg Up>		Stop	Stops media file
<Fn> + <Pg Dn>		Previous	Plays the previous media file in the play sequence
<Fn> + <End>		Next	Plays the next media file in the play sequence

Special Keys

On models that support the Euro symbol and the US dollar sign, the symbols can be located at the upper-center and/or bottom-right of your keyboard.

The Euro symbol

1. Open a text editor or word processor.
2. Hold <Alt Gr> and then press the <5> key at the upper-center of the keyboard.

NOTE: Some fonts and software do not support the Euro symbol. See www.microsoft.com/typography/faq/faq12.htm for more information.

The US dollar sign

1. Open a text editor or word processor.
2. Hold <Shift> and then press the <4> key at the upper-center of the keyboard.

NOTE: This function varies according to the language settings.

Hardware Specifications and Configurations

Processor

Item	Specification
CPU	<ul style="list-style-type: none"> CPU Intel Arrandale (DC) / Clarksfield (QC) processor
Type	<ul style="list-style-type: none"> MCP (Multi-Chip Package) CPU
CPU Package	989 pins-rPGA socket
Power	65 Watts
On-die Cache	<ul style="list-style-type: none"> Two or Four-core processor for mobile with enhanced performance 32-KB instruction and 32 -KB data first-level cache (L1) for each cor e 256-KB shared instruction/data second -level cache (L2) for each core Up to 8-MB shared instruction/data last -level cache (L3), shared among all cores
Front Side Bus	800/1066M/1333Hz

Processor Specifications

Item	CPU Speed	Cores	Bus Speed (GT/s)	Cache Size	Package	Core Voltage	Acer P/N
Ci3330M	2.13	2	2.5	3 MB	PGA988	35W	KC.33001.DMP
Ci3350M	2.26	2	2.5	3 MB	PGA988	35W	KC.35001.DMP
Ci5430M	2.26	2	2.5	3 MB	PGA988	35W	KC.43001.DMP
Ci5520M	2.24	2	2.5	3 MB	PGA988P	35W	KC.52001.DMP
Ci5540M	2.53	2	2.5	3 MB	PGA988	35W	KC.54001.DMP
Ci7620M	2.66	2	2.5	4 MB	PGA988P	35W	KC.62001.DMP
Ci7720QM	1.6	4	2.5	6 MB	PGA988	45W	KC.72001.QMP
Ci7820QM	1.73	4	2.5	8 MB	PGA988	45W	KC.82001.QMP

CPU Fan True Value Table (UMA)

CPU Temperature (Celcius)	Fan Speed (RPM)	SPL Spec (dBA)
45	2500	31
55	3100	34
65	3500	38
75	3900	40
85	4200	42

Throttling 50%: On= 100°C; OFF=85°C

OS shut down at 105°C; H/W shut down at 110°C

CPU Fan True Value Table (Discrete)

CPU Temperature (Celcius)	Fan Speed (RPM)	SPL Spec (dBA)
40	2500	31
50	3100	34
60	3500	38
70	3900	40
80	4200	42

Throttling 50%: On= 100°C; OFF=85°C

OS shut down at 105°C; H/W shut down at 110°C

Core Logic Specifications

Item	Specification
Chipset	Intel Ibex-Peak (HM55)
Package	1071-pins FCBGA 27mm x 25mm
Features	<ul style="list-style-type: none"> • PCI Express* Base Specification, Revision 2.0 support for up to eight ports. • PCI Local Bus Specification, Revision 2.3 support for 33 MHz PCI operations (supports up to four Req/Gnt pairs). • ACPI Power Management Logic Support, Revision 3.0b • Enhanced DMA controller, interrupt controller, and timer functions • Integrated Serial ATA host controllers with independent DMA operation on up to six ports. • FIS-based Port Multiplier support on SATA Ports 4 and 5 in AHCI/RAID mode. • USB host interface with support for up to twelve USB ports; two EHCI high-speed USB 2.0 Host controllers, 2 rate matching hubs, six UHCI host controllers; • System Management Bus (SMBus) Specification, Version 2.0 with additional support for I2C devices • Supports IntelR High Definition Audio • Supports IntelR Matrix Storage Technology • Supports IntelR Active Management Technology • Supports IntelR Virtualization Technology for Directed I/O • Supports IntelR Trusted Execution Technology • Supports buffered through mode generating extra clocks from a clock chip. • Analog and Digital Display ports <ul style="list-style-type: none"> • Analog CRT • HDMI • DisplayPort 1.1 (dGPU only) • LVDS • Low Pin Count (LPC) interface • Serial Peripheral Interface (SPI) support • IntelR Anti-Theft Technology • JTAG Boundary Scan support

System Memory

Item	Specification
Memory size	0MB (No on-board Memory)
DIMM socket number	4 sockets
Supports memory size per socket	4GB
Supports maximum memory size	16GB
Supports DIMM type	DDR3
Supports DIMM Speed	800/1066 MT/s

Memory Combinations

Slot 1	Slot 2	Total Memory
0MB	512MB	512MB
0MB	1024MB	1024MB
0MB	2048MB	2048MB
512MB	512MB	1024MB
512MB	1024MB	1536MB
512MB	2048MB	2560MB
1024MB	0MB	1024MB
1024MB	512MB	1536MB
1024MB	1024MB	2048MB
1024MB	2048MB	3072MB
2048MB	0MB	2048MB
2048MB	512MB	2560MB
2048MB	1024MB	3072MB
2048MB	2048MB	4096MB

NOTE: Above table lists some system memory configurations. You may combine DIMMs with various capacities to form other combinations. On above table, the configuration of slot 1 and slot 2 could be reversed.

Video Interface

Item	Specification	
Chipset	VGA chip Build-in Intel Graphics Media Accelerator HD	Broadway-Pro/Madison-Pro
Type	Arrandale HM55 PCH	MCP (Multi-Chip Package) CPU
Package	rPGA 989	<ul style="list-style-type: none"> 962-pins FCBGA 29mm x 29mm
Features	<ul style="list-style-type: none"> The integrated graphics controller contains a refresh of the 5th generation graphics core. IntelR Dynamic Video Memory Technology support IntelR Smart 2D Display Technology (IntelR S2DDT) IntelR Clear Video Technology <ul style="list-style-type: none"> MPEG2 Hardware Acceleration WMV9/VC1 Hardware Acceleration AVC Hardware Acceleration ProcAmp Advanced Pixel Adaptive De-interlacing Sharpness Enhancement De-noise Filter High Quality Scaling Film Mode Detection (3:2 pull - down) and Correction IntelR TV Wizard Microsoft DirectX*11 support Analog CRT DAC Interface Support (300MHz DAC/up to QXGA/Hot - Plug) Dual-Channel LVDS interface support 2x24 bpp panels 	<ul style="list-style-type: none"> Fully compliant with PCI Express Base Specification Rev. 2.1 Support CRT/LVDS/HDMI/DP interface (concurrent) Dual-channel LVDS interface support: single channel 24 bpp dual link HDCP compliance embed-in Full POWERPLAYTM 8.0 support LVDS / Engine and Memory / DP Spread Spectrum Support H.264 implementation is based on the ISO/IEC 14496-10 specification. VC-1 implementation is based on the SMPTE 421M specification. MPEG2 implementation is based on the ISO 13818 -2 Supports top quality DVD and Blu -Ray disc with the lowest CPU usage. VDDC (GPU core power supply) VDDCI (GPU I/O power supply) 1V (DP PLL power supply) 1.5V (VRAM and memory control power supply) 1.8V (CRT DAC and LVDS power supply) 3V (Peripheral power supply)

VRAM

Item	Specification
Chipset	AMD Broadway or Madison
Memory size	1GB
Interface	DDRIII

USB Port

Item	Specification
Chipset	Intel Ibex-Peak (HM55)
USB compliance level	2.0
UHCI	6
Number of USB port(s)	5
Location	3 Right side, 2 Left side
Serial port function control	N/A

HDMI Port

Item	Specification
Compliance level	1.3
Throughput	2.5Gbps
Number of HDMI port(s)	1
Location	Left side

PCMCIA Port(not included in this model)

Item	Specification
PCMCIA controller	
Supports card type	
Number of slots	
Access location	
Supports ZV (Zoomed Video) port	
Supports 32-bit CardBus	

System Board Major Chips

Item	Specification
Core logic	Intel Arrandale (DC) / Clarksfield (QC)
VGA	VGA chip Build-in Intel Graphics Media Accelerator HD Broadway-Pro/Madison-Pro
LAN	AR8151
USB 2.0	Intel Ibex-Peak (HM55)
Super I/O controller	N/A
Bluetooth	Intel Ibex-Peak (HM55)
Wireless (type=802.11 b+g)	Intel Ibex-Peak (HM55)
PCMCIA	N/A
Audio codec	ALC669X
Card reader	OZ888

Hard Disk Drive Interface

Item	Specification							
Capacity (MB)	160				250			
Vendor & Model Name	Seagate	HGST	Toshiba	WD	Seagate	HGST	Toshiba	WD
Bytes per sector	512				512			
Data heads	2		1		2		3	
Drive Format								
Disks	1		1		1		2	
Spindle speed (RPM)	5400				5400			
Performance Specifications								
Buffer size	8 MB				8 MB			
Interface	SATA				SATA			
Max. Media Transfer Rate (Mbytes/sec max.)	300	384	384	384	300	384	384	384
Max. Data Transfer Rate (Mbytes/sec)	150400	108160		108544	150400	112000		108544
DC Power Requirements								
Voltage tolerance	5V ±5%				5V ±5%			

Hard Disk Drive Interface (continued)

Item	Specification							
Capacity (MB)	320				500			
Vendor & Model Name	Seagate	HGST	Toshiba	WD	Seagate	HGST	Toshiba	WD
Bytes per sector	512				512			
Data heads	3	3	2	2	2		3	2
Drive Format								
Disks	2	2	1		1		2	1
Spindle speed (RPM)	5400				5400			
Performance Specifications								
Buffer size	8 MB				8 MB			
Interface	SATA				SATA			
Max. Media Transfer Rate (Mbytes/sec max.)	300	384	384	384	300	384	384	384
Max. Data Transfer Rate (Mbytes/sec)	150400	112000		108544	150400	112000		108544
DC Power Requirements								
Voltage tolerance	5V ±5%				5V ±5%			

BIOS

Item	Specification
BIOS vendor	Insyde BIOS
BIOS version	3.5
BIOS ROM type	Flash
Features	<ul style="list-style-type: none"> • Flash ROM 4MB • Support ISIPP • Support Acer UI • Support multi-boot • Suspend to RAM (S3)/Disk (S4) • Various hot-keys for system control • Support SMBIOS 2.3, PCI2.2. • Refer to Acer BIOS specification. • DMI utility for BIOS serial number configurable/asset tag • Support PXE • Support Y2K solution • Support WinFlash • Wake on LAN from S3 • Wake on LAN form S4 in AC mode • System information

LCD 18.47”

Item	Specification
Vendor/model name	ChiMei N184H6 - L02
Screen Diagonal (mm)	18.47 inches
Display resolution (pixels)	1920 x 1080
Driver Element	a-si TFT active matrix
Pixel Pitch (mm)	0.213 (H) x 0.213 (V)
Display Mode	Normally White
Typical White Luminance (cd/m ²) (also called Brightness)	200
Contrast Ratio	650 typical
Response Time (Optical Rise Time/Fall Time) msec	Tr 2, Tf 6
White Variation	1.25 typical
Electrical Interface	LVDS
Support Color	262K
Viewing Angle (up/down/right/ left)	20/45/45/45
Temperature Range (°C)	
Operating	0 to +50
Storage (shipping)	-20 to +60

LCD Inverter(not included in this model)

Item	Specification
Vendor & model name	
Brightness conditions	
Input voltage (v)	
Input current (mA)	
Output voltage (V, RMS)	
Output current (mA, RMS)	
Output voltage frequency (KHz)	

LCD Display Supported Resolution

Resolution	24 bits	30 bits	36 bits	48 bits
640x480p/60Hz 4:3	Yes	Yes	Yes	Yes
720x480p/60Hz 4:3	Yes	Yes	Yes	Yes
720x480p/60Hz 16:9	Yes	Yes	Yes	Yes
1280x720p/60Hz 16:9	Yes	Yes	Yes	Yes
1920x1080i/60Hz 16:9	Yes	Yes	Yes	Yes
1440x480i/60Hz 4:3	Yes	Yes	Yes	Yes
1440x480i/60Hz 16:9	Yes	Yes	Yes	Yes
1920x1080p/60Hz 16:9	Yes	Yes	Yes	Yes
720x576p/50Hz 4:3	Yes	Yes	Yes	Yes
720x576p/50Hz 16:9	Yes	Yes	Yes	Yes
1280x720p/50Hz 16:9	Yes	Yes	Yes	Yes
1920x1080i/50Hz 16:9	Yes	Yes	Yes	Yes
1440x576i/50Hz 4:3	Yes	Yes	Yes	Yes
1440x576i/50Hz 16:9	Yes	Yes	Yes	Yes
1920x1080p/50Hz 16:9	Yes	Yes	Yes	Yes

Bluetooth

Item	Specification		
Bluetooth Controller	Foxconn BCM2070 BT2.1+EDR (T77H114.01)	Foxconn BCM2046 BT2.1+EDR Module (T60H928.33)	Foxconn AR3011 BT Module (T77H056.00)
Features	<ul style="list-style-type: none"> Bluetooth 2.1 compliant Point-to-multipoint operation External USB interface for data Onboard antenna and SMA RF connector Coexistence support 	<ul style="list-style-type: none"> Fully Qualified Bluetooth v2.1 with Class 2 specification RF output power. Enhanced Data Rate (EDR) compliant. Full Piconet and Scatternet operation. Integrated PIFA Antenna with better RF performance. USB 2.0 compliant interface. F/W upgradable via Flash downloads. Very low power consumption. Support Coexistence with Intel WCS (Wireless Coexistence System) & AFH (Adaptive Frequency Hopping). 	<ul style="list-style-type: none"> Single-chip Bluetooth v2.1 + EDR solution USB 2.0 full-speed device interface with support for Device Firmware Upgrade(DFU) SPI interface supports external serial flash devices Two on-chip 1.2V linear voltage regulators Integrated 32-bit CPU with 32KB data RAM and 256KB program RAM On-board PLL On-chip low power oscillator(LPO) WLAN coexistence interface Standard USB HCI interface

Audio Subsystem

Item	Specification
Audio Codec	
Chipset	Realtek ALC669X-GR
Package	Intel Ibex Peak_M mBGA 676
Speaker Amplifier	TPA6047A4
Audio port	
Internal	
Compatibility	<ul style="list-style-type: none"> EAX™ 1.0 & 2.0 compatible Direct Sound 3D™ compatible I3DL2 compatible
Sampling rate	<ul style="list-style-type: none"> Primary 16/20/24-bit SPDIF-OUT supports 32k/44.1k/48k/88.2k/96k/192kHz sample rate Secondary 16/20/24-bit SPDIF-OUT supports 32k/44.1k/48k/88.2k/96k/192kHz sample rate
External	
	<ul style="list-style-type: none"> Mic jack Headphone jack Line-in jack

LAN Interface

Item	Specification
LAN Chipset	ATHEROS AR8151
Package	48pin QFN
Features	<ul style="list-style-type: none">• The AR8151 is the fifth generation Gigabit Ethernet (GbE) controller solution from Atheros. It is an ultra-high performance, ultralow cost, and ultra-low power fully integrated 10/100/1000 Mbps NIC/LOM Ethernet controller perfectly suited for both PC and embedded applications.• The AR8151 combines a 10/100/1000BASE-T GbE media access controller (MAC), a triplespeed Ethernet physical layer transceiver (PHY), a PCI Express bus interface, and a 25 MHz shared-source clock input and the AR8151 contains an embedded 256 byte Onetime Programmable (OTP) memory (using on-die eFuse technology).• The AR8151 is compliant with IEEE 802.3u specification for 10/100 Mbps Ethernet and IEEE 802.3ab specification for 1000 Mbps Ethernet. The AR8151 device combines pulse shaping, Tx/Rx PCS, echo canceller, NEXT canceller, equalizer, decoder, and timing recovery functions to deliver robust signal performance in noisy environments• The AR8151 GbE controller supports checksum offload features for IP, TCP, and UDP, lowering CPU utilization and optimizing network performance.

Keyboard

Item	Specification
Type	ACER AC7T_A10B AC7T Internal 17
Total number of keypads	103/104/107
Windows logo key	Yes
Internal & external keyboard work simultaneously	Yes
Features	<ul style="list-style-type: none">• Supports application keys for Windows 7 version

Media Card Reader

Item	Specification
Chipset	AU6437-GBL -GR
Package	LQFP
Features	<ul style="list-style-type: none">• Fully compatible with USB2.0 High Speed and backward compatible with USB1.1 specifications• Supports multiple flash card interfaces, including SD/MMC/xD/MS.• Supports single LUN• Supports both Windows and Mac OS

I/O Ports

Item	Specification
I/O support	<ul style="list-style-type: none"> • Acer Bio-Protection fingerprint reader • Multi-in-1 card reader (SD™, MMC, MS, MS PRO, xD) • Five USB 2.0 ports • eSATA port • IEEE 1394 port • HDMI™ port with HDCP support • Consumer infrared (CIR) port • External display (VGA) port • Headphone/speaker/line-out jack with S/PDIF support • Microphone-in jack • Line-in jack • Ethernet (RJ-45) port • DC-in jack for AC adapter

Camera 1.3M

Item	Specifications		
Vendor and model	SUYIN HF1315-S32B-OV0	Chicony CNF9157	Liteon 09P2BF127 / Liteon 09P2SF119
Type	CMOS image sensor with SXGA	CMOS image sensor with SXGA	CMOS image sensor with SXGA
Interface	USB Port 2.0	USB Port 2.0	USB Port 2.0
Focusing distance	70cm	70 cm	60 cm
Dimensions (L x W x H mm)	65 x 8.0 x 3.74 mm	65.0±0.3 X 8.0±0.1 X 3.69+0.11/-0.2 mm	65.0 x 8.0 x 3.53 ± 0.2mm
Sensor type	OV9665		OV9665
Pixel resolution	1280x1024	1280x1024	1280x1024
Pixel size	2 µm x 2 µm		2 µm x 2 µm
Image size	3.89mm(H) X 2.43mm(V)Part number		

Wireless LAN

Item	Specification		
Type	Atheros HB95	Atheros HB93	Intel MM#903341
Wireless Standards Supported	b, g	b, g, n	b, n

3G Card (not included in this model)

Item	Specification
	•

Super-Multi Drive Module

Item	Specification				
Vendor & model name	HLDS GT30N		HLDS CT21N		
Performance Specification	With CD Diskette	With DVD Diskette	With CD Diskette	With DVD Diskette	With BD Diskette
Transfer rate (MB/sec)	Sustained: 3,600 KB/s (24x) max.	Sustained: 11.08 Mbytes/s (8x) max.	Sustained: 3,600 kB/s (24x) max.	Sustained: 11.08 Mbytes/ s (8x) max.	Sustained: 215.79 Mbits/s (6x) max.
Buffer Memory	1 MB		2 MB		
Interface	SATA				
Applicable disc formats	DVD-ROM, DVD-R (Ver.1.0, Ver. 2.0 for Authoring) DVD-R (Ver. 2.1 for General), DVD-R DL (Dual Layer), DVD-RW, DVD-RAM (Ver.2.2), DVD+R, DVD+R DL (Double Layer), and +RW CD-ROM, CD-ROM XA, CD-I, Video CD, CD-Extra and CD-Text Photo CD (Single and Multi session) CD-DA Super Audio CD (Compatible layer in Hybrid type) CD-R discs conforming to "Orange Book Part 2" CD-RW discs conforming to "Orange Book Part 3" CPRM (DVD-R/RW/RAM) supported		DVD-ROM, BD-ROM (SL/DL), BD-R (SL/DL) and BD-RE (SL/DL) DVD-R (SL/DL), DVD-RW (SL), DVD-RAM, DVD+R (SL/DL) and +RW CD-ROM, CD-ROM XA, CD-I, Video CD, CD-Extra and CD-Text Photo CD (Single and Multi session) CD-DA CD-R discs conforming to "Orange Book Part 2" CD-RW discs conforming to "Orange Book Part 3" DVD-R(SL/DL) / -RW / RAM with CPRM "CD layer" of Super Audio CD Hybrid type		
Loading mechanism	Drawer (Solenoid Open) Tact SW (Open) Emergency Release (draw open hole)				
Power Requirement					
Input Voltage	DC 5 V +/- 5%				

Battery

Item	Specification	
Vendor & model name	Panasonic NCR-B/811	Quanta : Acer AS10C7E
Battery Type	Lithium-Ion	Lithium-Ion
Pack nominal capacity	6140mAh	5900mAh
Number of battery cell	6 cell	8 cell
Package configuration	2P4S	4S2P

AC Adapter

Item	Specification
Input	100 - 240V ~ 2.0A
Input Frequency Range	50 ~ 60 Hz
Inrush current	less than 150A at 240V
Efficiency	85% min. at 115Vac input

System Power Management

Item	S5_ON	SUSON	MAINON	VRON	+NB_CORE
Initial	0	0	0	0	0
On (S0)	1	1	1	1	1
Standby (S1)	1	1	1	1	1
Suspend (S3)	1	1	0	0	0
Hibernate (S4)	1	0	0	0	0
Soft Off (S5)	1	0	0	0	0

System LED Indicator

Item	Specification
Power	Power on = Blue Suspend = Orange
Battery Charging	In charge = Orange Charge finish = Blue
Wireless	On = Blue
Backup	On = Blue
Power save	On = Blue

Power Specification

Item	Specification					
	Initial	On	Stand by	Suspend	Hibernate	Soft Off
Initial		1				
ON (S0)			2	3	4	5
Standby (S1)		6				
Suspend (S3)		7				
Hibernate (S4)		8				
Soft Off (S5)		9				

*Mechanical off is a condition where all power except the RTC battery has been removed from the system.

1. Initial to On state: When the AC adapter or Battery pack has been plugged into the system, the I WPC781 will be reset and initial all output pins then the system goes into Initial state and waiting for power on event. If the power button is pressed then the system will go into the ON state.
2. ON to Standby state: The system will go into the Standby state when HM55 receives the POS command.
3. ON to Suspend state: The system will go into Suspend state when HM55 receives the S2R command.
4. ON to Hibernate state: The system will go into Hibernate state when HM55 receives the S2D command.
5. ON to Soft Off state: The system will go into Soft Off state when HM55 receives the Soft off command.
6. Standby to ON state: The system will go into ON state when the system receives any wake up events, for example, keyboard, mouse.
7. Suspend to ON state: The system will go into ON state when the power button is pressed.
8. Hibernate to ON state: The system will go into ON state when the power button is pressed.
9. Soft Off to ON state: The system will go into ON state when the power button is pressed.

System Utilities

BIOS Setup Utility

The BIOS Setup Utility is a hardware configuration program built into your computer's BIOS (Basic Input/Output System).

Your computer is already properly configured and optimized, and you do not need to run this utility. However, if you encounter configuration problems, you may need to run Setup. Please also refer to Chapter 4 Troubleshooting when problem arises.

To activate the BIOS Utility, press **F2** during POST (when **Press <F2> to enter Setup** message is prompted on the bottom of screen).

Press **F2** to enter setup. The default parameter of F12 Boot Menu is set to "disabled". If you want to change boot device without entering BIOS Setup Utility, please set the parameter to "enabled".

Press **<F12>** during POST to enter multi-boot menu. In this menu, user can change boot device without entering BIOS SETUP Utility.

Navigating the BIOS Utility

There are five menu options: Information, Main, Security, Boot, and Exit.

Follow these instructions:

- To choose a menu, use the left and right arrow keys.
- To choose an item, use the up and down arrow keys.
- To change the value of a parameter, press **F5** or **F6**.
- A plus sign (+) indicates the item has sub-items. Press **Enter** to expand this item.
- Press **Esc** while you are in any of the menu options to go to the Exit menu.
- In any menu, you can load default settings by pressing **F9**. You can also press **F10** to save any changes made and exit the BIOS Setup Utility.

NOTE: You can change the value of a parameter if it is enclosed in square brackets. Navigation keys for a particular menu are shown on the bottom of the screen. Help for parameters are found in the Item Specific Help part of the screen. Read this carefully when making changes to parameter values. **Please note that system information is subject to different models.**

Information

The Information screen displays a summary of your computer hardware information.

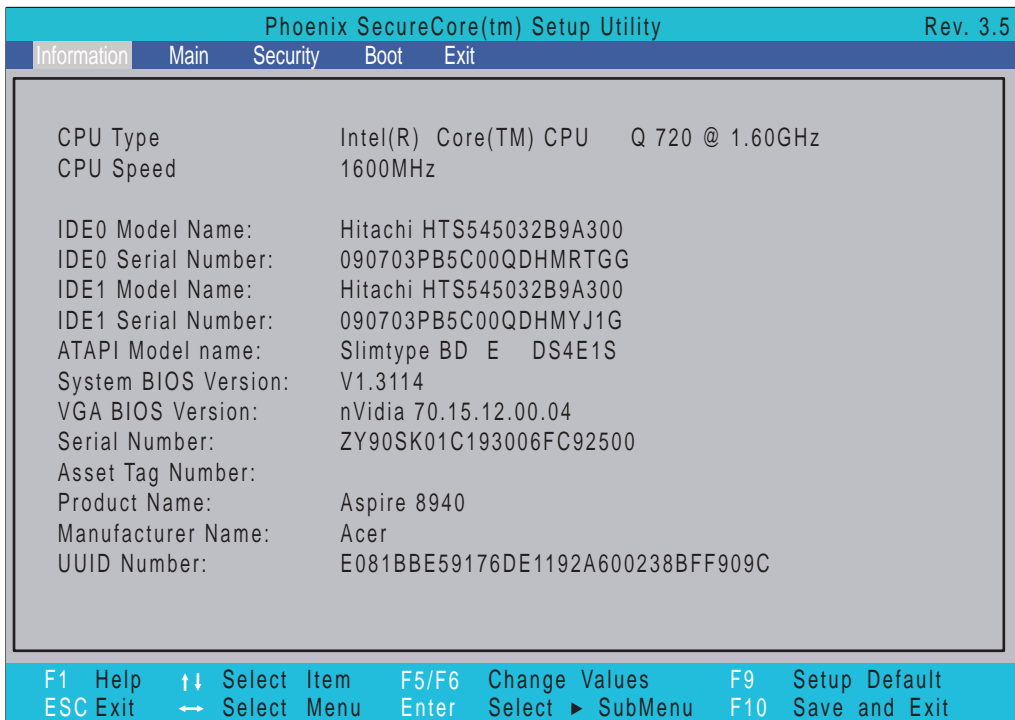

NOTE: The system information is subject to different models.

Parameter	Description
CPU Type	This field shows the CPU type and speed of the system.
CPU Speed	This field shows the speed of the CPU.
IDE0 Model Name	This field shows the model name of HDD installed on primary IDE master.
IDE0 Serial Number	This field displays the serial number of HDD installed on primary IDE master.
IDE1 Model Name	This field shows the model name of HDD installed on primary IDE slave.
IDE1 Serial Number	This field displays the serial number of HDD installed on primary IDE slave.
ATAPI Model Name	This field displays the model name of the installed ODD drive.
System BIOS Version	Displays system BIOS version.
VGA BIOS Version	This field displays the VGA firmware version of the system.
Serial Number	This field displays the serial number of this unit.
Asset Tag Number	This field displays the asset tag number of the system.
Product Name	This field shows product name of the system.
Manufacturer Name	This field displays the manufacturer of this system.
UUID Number	Universally Unique Identifier (UUID) is an identifier standard used in software construction, standardized by the Open Software Foundation (OSF) as part of the Distributed Computing Environment (DCE).

Main

The Main screen allows the user to set the system time and date as well as enable and disable boot option and recovery.

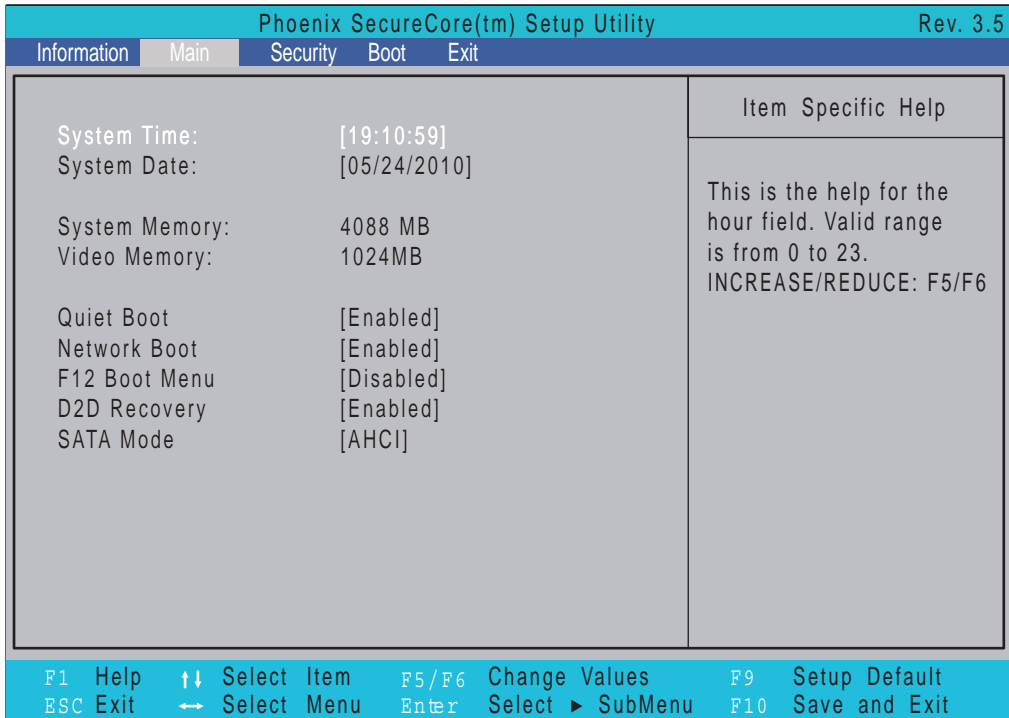

NOTE: The screen above is for your reference only. Actual values may differ.

The table below describes the parameters in this screen. Settings in **boldface** are the default and suggested parameter settings.

Parameter	Description	Format/Option
System Time	Sets the system time. The hours are displayed with 24-hour format.	Format: HH:MM:SS (hour:minute:second)
System Date	Sets the system date.	Format MM/DD/YYYY (month/day/year)
System Memory	This field reports system memory size.	N/A
Video Memory	Shows the video memory size. VGA Memory size=32 MB	N/A
Quiet Boot	This will hide POST messages while booting.	Option: Enabled or Disabled
Network Boot	Enables, disables the system boot from LAN (remote server).	Option: Enabled or Disabled
F12 Boot Menu	Enables, disables Boot Menu during POST.	Option: Disabled or Enabled
D2D Recovery	Enables, disables D2D Recovery function. The function allows the user to create a hidden partition on hard disc drive to store the operation system and restore the system to factory defaults.	Option: Enabled or Disabled
SATA Mode	Control the mode in which the SATA controller should operate.	Option: AHCI mode or IDE mode

Security

The Security screen contains parameters that help safeguard and protect your computer from unauthorized use.

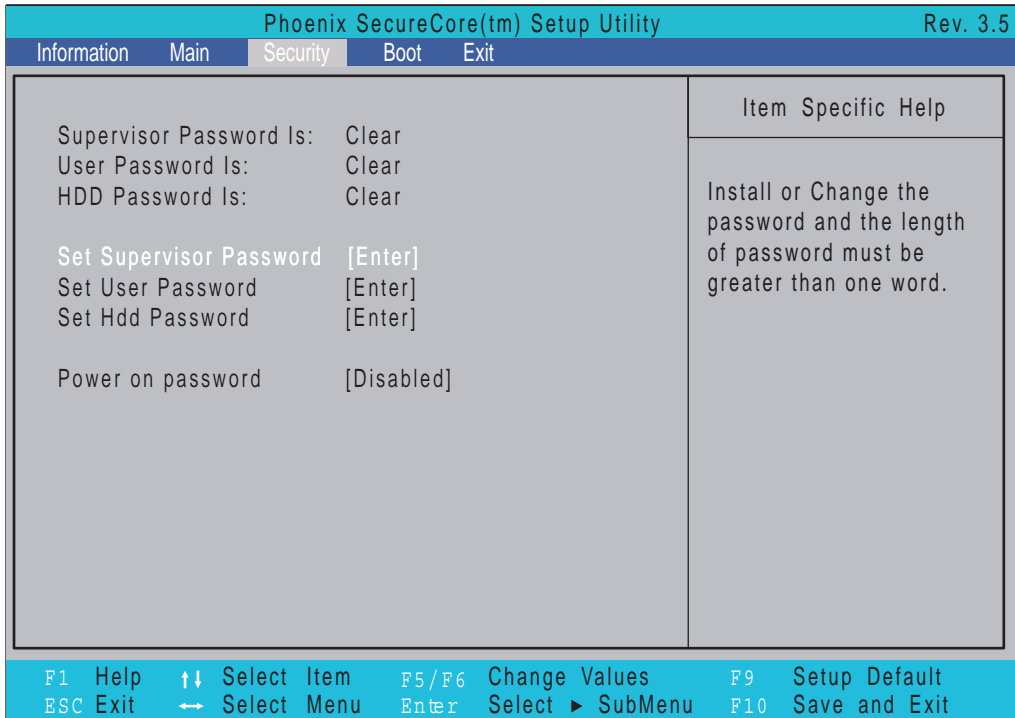

The table below describes the parameters in this screen. Settings in **boldface** are the default and suggested parameter settings.

Parameter	Description	Option
Supervisor Password Is	Shows the setting of the Supervisor password	Clear or Set
User Password Is	Shows the setting of the user password.	Clear or Set
IDEO HDD Password Is	Shows the setting of the HDD password	Clear or Set
Set Supervisor Password	Press Enter to set the supervisor password. When set, this password protects the BIOS Setup Utility from unauthorized access. The user can not either enter the Setup menu nor change the value of parameters.	
Set User Password	Press Enter to set the user password. When user password is set, this password protects the BIOS Setup Utility from unauthorized access. The user can enter Setup menu only and does not have right to change the value of parameters.	
Set Hdd Password	Press Enter to set the HDD password. When set this protects the HDD from unauthorized access.	
Power on password	Defines whether a password is required or not while the events defined in this group happened. The sub-options all require the Supervisor password for changes and should be grayed out if the user password was used to enter setup.	Disabled or Enabled

NOTE: When you are prompted to enter a password, you have three tries before the system halts. Don't forget the password. If you forget the password, you may have to reset the computer.

Setting a Password

Follow these steps as you set the user or the supervisor password:

1. Use the ↑ and ↓ keys to highlight the Set Supervisor Password parameter and press the **Enter** key. The Set Supervisor Password box appears:

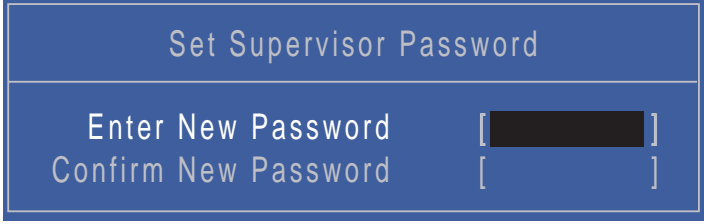

Set Supervisor Password	
Enter New Password	[██████████]
Confirm New Password	[]

2. Type a password in the “Enter New Password” field. The password length can not exceeds 8 alphanumeric characters (A-Z, a-z, 0-9, not case sensitive). Retype the password in the “Confirm New Password” field.

IMPORTANT: Be very careful when typing your password because the characters do not appear on the screen.

3. Press **Enter**. After setting the password, the computer sets the User Password parameter to “Set”.
4. If desired, you can opt to enable the Password on boot parameter.
5. When you are done, press F10 to save the changes and exit the BIOS Setup Utility.

Removing a Password

Follow these steps:

1. Use the ↑ and ↓ keys to highlight the Set Supervisor Password parameter and press the **Enter** key. The Set Password box appears:



Set Supervisor Password	
Enter Current Password	[██████████]
Enter New Password	[]
Confirm New Password	[]

2. Type the current password in the Enter Current Password field and press **Enter**.
3. Press **Enter** twice **without** typing anything in the Enter New Password and Confirm New Password fields. The computer then sets the Supervisor Password parameter to “Clear”.
4. When you have changed the settings, press **F10** to save the changes and exit the BIOS Setup Utility.

Changing a Password

1. Use the ↑ and ↓ keys to highlight the Set Supervisor Password parameter and press the **Enter** key. The Set Password box appears.



The screenshot shows a blue BIOS screen titled "Set Supervisor Password". It contains three input fields: "Enter Current Password", "Enter New Password", and "Confirm New Password". The first field is filled with blacked-out characters, while the other two are empty.

2. Type the current password in the Enter Current Password field and press **Enter**.
3. Type a password in the Enter New Password field. Retype the password in the Confirm New Password field.
4. Press **Enter**. After setting the password, the computer sets the User Password parameter to "Set".
5. If desired, you can enable the Password on boot parameter.
6. When you are done, press **F10** to save the changes and exit the BIOS Setup Utility.

If the verification is OK, the screen will display as following.



The screenshot shows a white BIOS screen titled "Setup Notice". The text "Changes have been saved." is displayed in the center. At the bottom, there is a black button with the word "Continue" in white.

The password setting is complete after the user presses **Enter**.

If the current password entered does not match the actual current password, the screen will show you the Setup Warning.



The screenshot shows a white BIOS screen titled "Setup Warning" in red text. Below the title, the text "Invalid Password." is displayed in red. At the bottom, there is a black button with the word "Continue" in white.

If the new password and confirm new password strings do not match, the screen displays the following message.



The screenshot shows a white BIOS screen titled "Setup Warning" in red text. Below the title, the text "Passwords do not match. Re-enter password." is displayed in red. At the bottom, there is a black button with the word "Continue" in white.

Boot

This menu allows the user to decide the order of boot devices to load the operating system. Bootable devices includes the USB diskette drives, the onboard hard disk drive and the DVD drive in the module bay.

Phoenix SecureCore(tm) Setup Utility				Rev. 3.5
Information	Main	Security	Boot	Exit
Boot priority order: 1: CD/DVD : Slimtype BD E DS4E1S-(S2 2: IDE0 : Hitachi HTS545032B9A300-(S 3: USB FDD : 4: PCI LAN : MBA v11.4.1 Slot 0900 5: USB HDD : 6: USB CD/DVD : 7: USB KEY : 8: Excluded from boot order : : IDE 1: Hitachi HTS545032B9A300-(S				Item Specific Help Use <↑> or <↓> to select a device, then press <F5> to move it down the list, or <F6> to move it up the list. Press <Esc> to escape the menu
F1 Help	↑↓ Select Item	F5/F6 Change Values	F9 Setup Default	
ESC Exit	←→ Select Menu	Enter Select ► SubMenu	F10 Save and Exit	

Exit

The Exit screen allows you to save or discard any changes you made and quit the BIOS Utility.

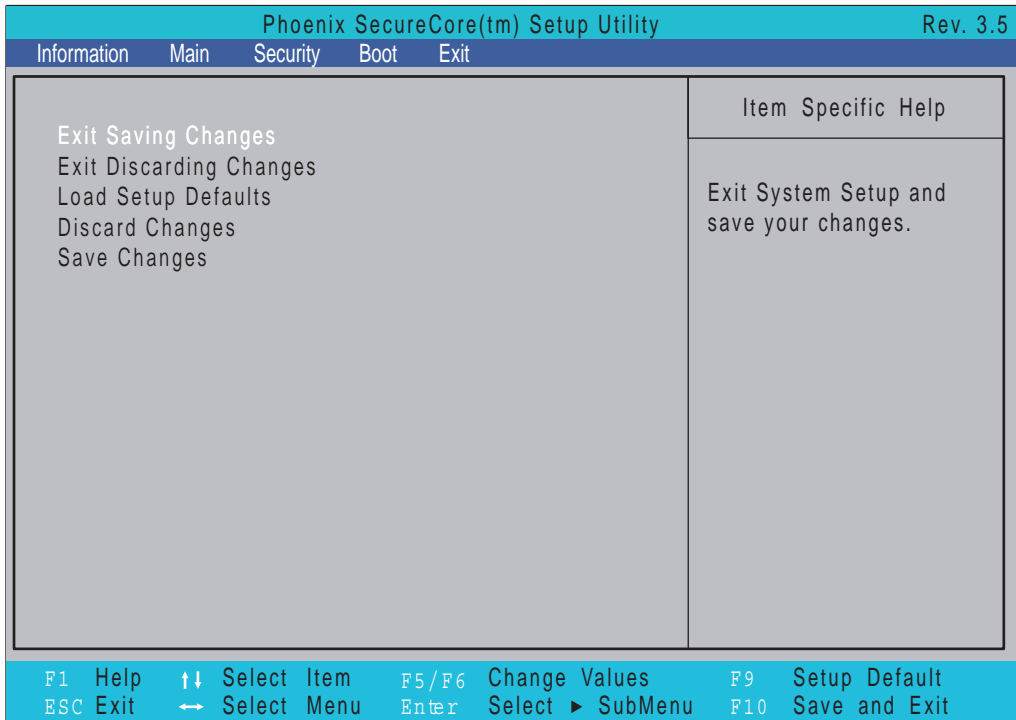

The table below describes the parameters in this screen.

Parameter	Description
Exit Saving Changes	Exit System Setup and save your changes to CMOS.
Exit Discarding Changes	Exit utility without saving setup data to CMOS.
Load Setup Default	Load default values for all SETUP item.
Discard Changes	Load previous values from CMOS for all SETUP items.
Save Changes	Save Setup Data to CMOS.

BIOS Flash Utility

The BIOS flash memory update is required for the following conditions:

- New versions of system programs
- New features or options
- Restore a BIOS when it becomes corrupted.

DOS Flash Utility

Perform the following steps to use the DOS Flash Utility:

1. Press F2 during boot to enter the Setup Menu.
2. Select **Boot Menu** to modify the boot priority order, for example, if using USB HDD to Update BIOS, move USB HDD to position 1.

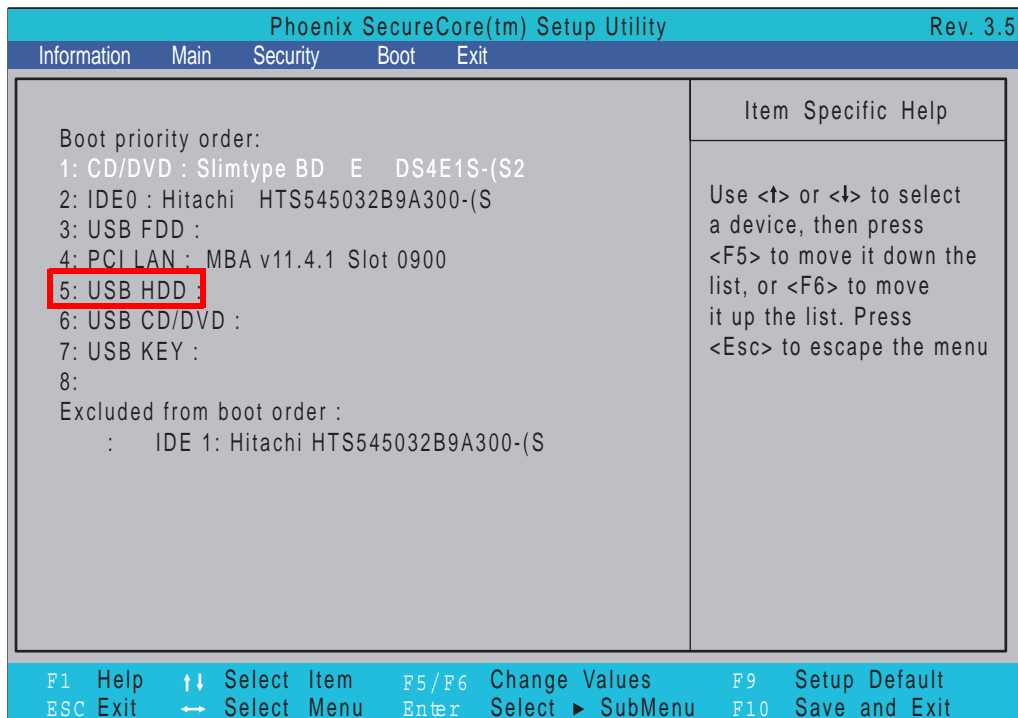

3. Execute the **FLASH.BAT** batch file to update BIOS. Or enter C:\ **Flash it bios ver.fd/dc**

The flash process begins as shown.

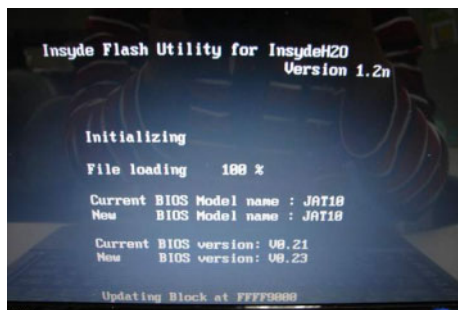

4. In flash BIOS, the message **Please do not remove AC Power Source** displays.

NOTE: If the AC power is not connected, the following message displays.

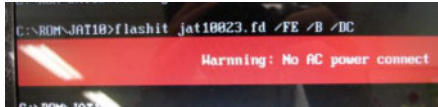

Plug in the AC power to continue.

5. Flash is complete when the message Flash programming complete displays.

WinFlash Utility

Perform the following steps to use the WinFlash Utility:

1. Double click the WinFlash executable.
2. Click **OK** to begin the update. A progress screen displays.

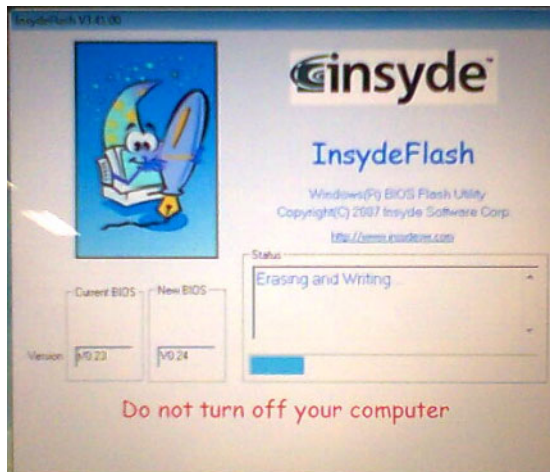

3. When the process is complete, close all programs and applications and reboot the system.

Remove HDD/BIOS Password Utilities

This section provide you with removing HDD/BIOS method:

Remove HDD Password:

When the user keys in the wrong password three times, the system reports the following error code to user.

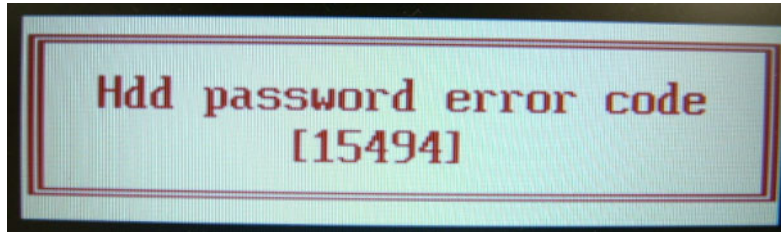

To unlock the HDD password, perform the following steps:

1. Run HDD_PW.EXE.
2. Select 2.
3. Choose one of the following strings :

0KJFN42

UVEIQ96

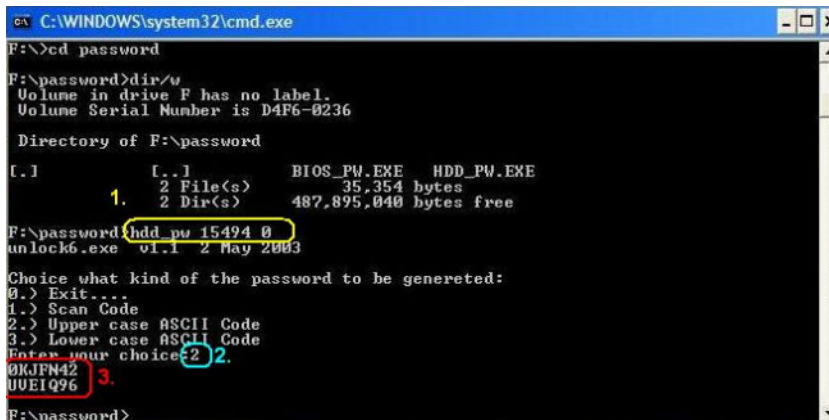

4. Reboot the system.
5. When prompted for the HDD User Password, enter the password generated in Step 3.

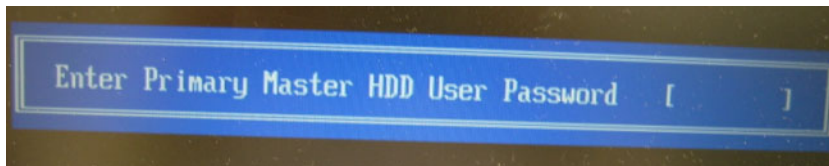

6. Save and exit the BIOS to complete the process.

Removing BIOS Passwords:

If you key in the wrong Supervisor Password three times, System Disabled displays on the screen. See the image below.

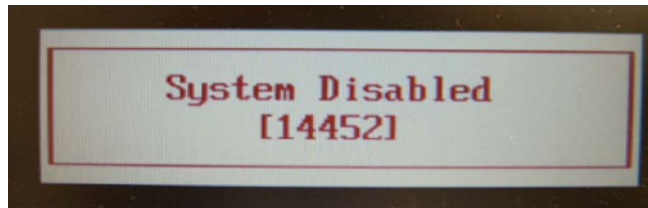

To reset the BIOS password, run **bios_pw.exe** as follows:

1. Enter "bios_pw 14452 0"
2. Choose one of the following strings:

qjig9vy

07yqmjd

cjl14tm

6mbzjaj



```
ca C:\WINDOWS\system32\cmd.exe
Microsoft Windows XP [Version 5.1.2600]
(C) Copyright 1985-2001 Microsoft Corp.
C:\Documents and Settings\M54>d:
D:\>bios_pw 14452 0 1.
unlock6.exe v1.0 1 July 1997
qjig9vy
07yqmjd
cjl14tm
6mbzjaj 2.
D:\>_
```

3. Reboot the system.
4. When prompted for the BIOS user password, enter the password generated in Step 2.

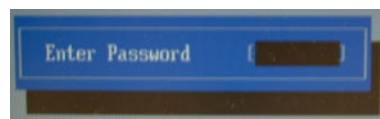

5. Save and exit the BIOS to complete the process.

Miscellaneous Utilities

Using Boot Sequence Selector

Boot Sequence Selector allows the boot order to be changes without accessing the BIOS. To use Boot Sequence Selector, perform the following steps:

1. Enter into DOS.
2. Execute BS.exe to display the usage screen.

```
d:\BOOTSEQ>bs
*** Boot Sequence Selector Version 0.03 ***
Create by Rockwell Chuang 10/01/2005.
Usage:
      BS [ 1 | 2 | 3 | 4 ]
BS 1 : [ Floppy ] => [HardDisk] => [ CD-ROM ] => [ LAN   ]
BS 2 : [HardDisk] => [ CD-ROM ] => [ LAN   ] => [ Floppy ]
BS 3 : [ CD-ROM ] => [HardDisk] => [ LAN   ] => [ Floppy ]
BS 4 : [ LAN   ] => [ Floppy ] => [HardDisk] => [ CD-ROM ]
d:\BOOTSEQ>
```

3. Select the desired boot sequence by entering the corresponding sequence, for example, enter BS2 to change the boot sequence to HDD|CD ROM|LAN|Floppy.

Using DMITools

The DMI (Desktop Management Interface) Tool copies BIOS information to eeprom to be used in the DMI pool for hardware management.

When the BIOS displays **Verifying DMI pool data** it is checking the table correlates with the hardware before sending to the operating system (Windows, etc.).

To update the DMI Pool, perform the following steps:

1. Enter into DOS.
2. Execute **qdmis30a.exe**. The following messages show dmitools usage:

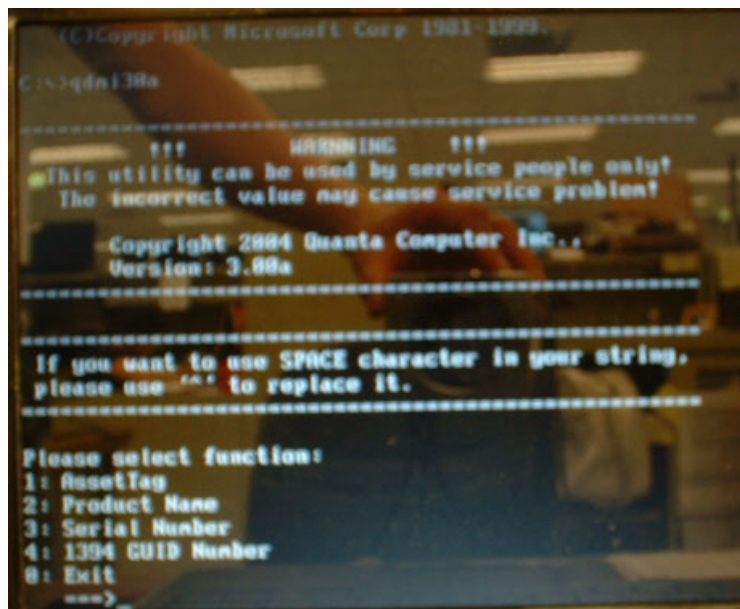

3. Enter the required key number of the feature required to be modified. See the following table.

Key No.	Function Description
1	Enter 1 to modify the Asset Tag
2	Enter 2 to modify the Product Name
3	Enter 3 to modify the Serial Number
4	Enter 4 to modify the 1394 GUID Number
0	Enter 0 to exit the program

Using the LAN MAC Utility

Perform the following steps to write MAC information to eeprom:

1. Use a text editor, for example Notepad, to edit the MAC.CFG file as shown:

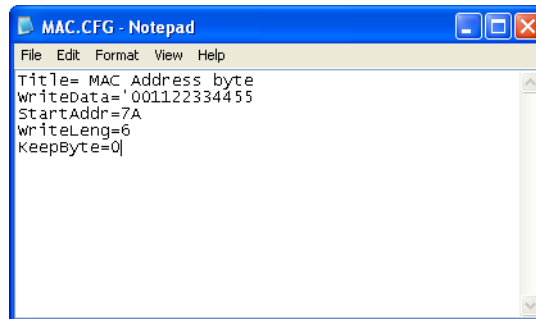

```
MAC.CFG - Notepad
File Edit Format View Help
Title= MAC Address byte
WriteData='001122334455'
StartAddr=7A
WriteLeng=6
KeepByte=0
```

- WriteData= '001122334455' <----- MAC value
 - StartAddr=7A <----- MAC address
 - WriteLeng=6 <----- MAC value length
 - KeepByte=0 <----- can be any value
2. Boot into DOS.
3. Execute **MAC.BAT** to write MAC information to eeprom.

Machine Disassembly and Replacement

This chapter contains step-by-step procedures on how to disassemble the notebook computer for maintenance and troubleshooting.

Disassembly Requirements

To disassemble the computer, you need the following tools:

- Wrist grounding strap and conductive mat for preventing electrostatic discharge
- Flat screwdriver
- Philips screwdriver
- Plastic flat screwdriver
- Plastic tweezers

NOTE: The screws for the different components vary in size. During the disassembly process, group the screws with the corresponding components to avoid mismatch when putting back the components.

Related Information

The product previews seen in the disassembly procedures may not represent the final product color or configuration.

IMPORTANT: Cable paths and positioning may not represent the actual model. During the removal and replacement of components, ensure all available cable channels and clips are used and that the cables are replaced in the same position.

Replacement Requirements

NOTE: Cabling and components require adhesive to be applied during the replacement and reassembly process.

NOTE: During manufacture a cyanoacrylate glue is used provided by Holdtite Adhesives LTD. This is not a specified requirement. The reassembler is free to select an alternative appropriate adhesive.

Pre-disassembly Instructions

Before proceeding with the disassembly procedure, make sure that you do the following:

1. Turn off the power to the system and all peripherals.
2. Unplug the AC adapter and all power and signal cables from the system.

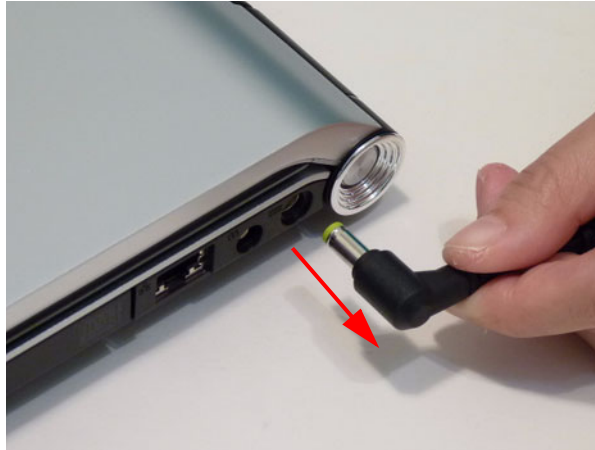

3. Place the system on a flat, stable surface.

Disassembly Process

The disassembly process is divided into the following sections:

- External components disassembly
- Main unit disassembly
- LCD module disassembly

The flowcharts provided in the succeeding disassembly sections illustrate the entire disassembly sequence. Observe the order of the sequence to avoid damage to any of the hardware components. For example, if you want to remove the mainboard, you must first remove the Keyboard, and LCD Module then disassemble the inside assembly frame in that order.

Main Screw List

Acer Description	Quantity	P/N
SCREW 1.98D 3.0L K 4.6D 0.8T ZK NL	17	86.PWL02.002
SCREW 2.5D 5.7+2L K 6.0D ZK NL CR3	29	86.PWL02.003
SCREW 1.6D 2.5L K 3.0D NI NL 0.3T	6	86.PWL02.004
SCREW 2.5D 5L K 5.5D ZK NL CR3	4	86.PWL02.006
SCREW 3.0D 3.0L K 4.9D NI	2	86.PWL02.009
SCREW 2.5D 3.4+2.6L K 4.5D ZK CR3	43	86.PWL02.010

External Module Disassembly Process

NOTE: The product previews seen in the disassembly procedures may not represent the final product color or configuration.

External Modules Disassembly Flowchart

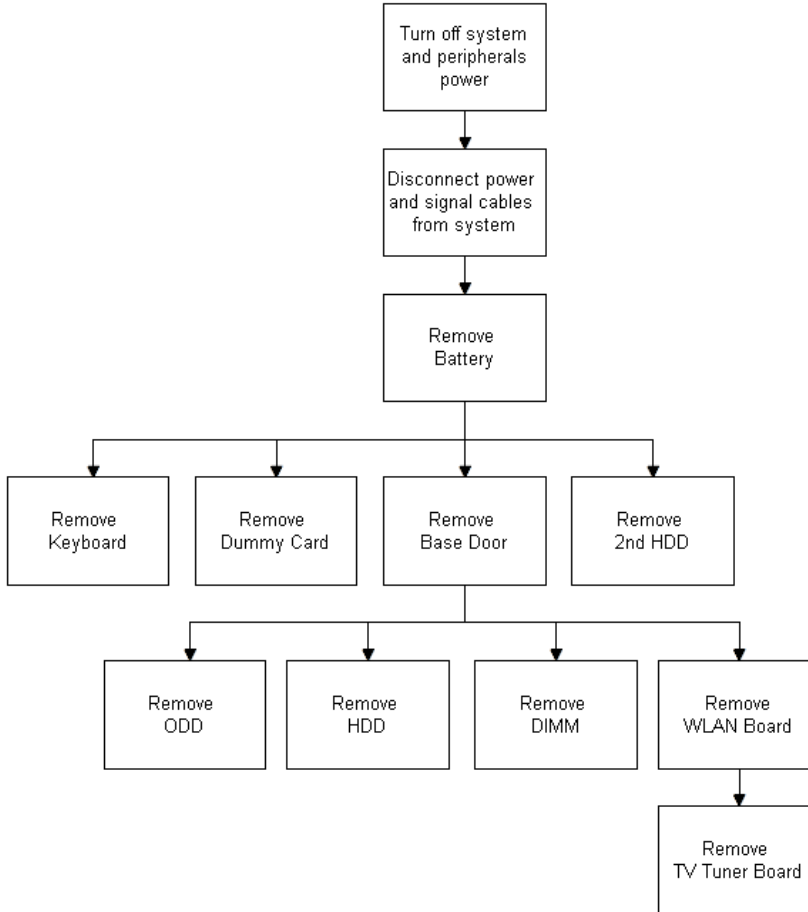

External Module Screw List

Step	Screw	Quantity	Part No.
Base Cover Disassembly	M2.5*4	9	86.PWL02.010
Master HDD Bracket Disassembly	M3*3.5 Ni	2	86.PWL02.009
Master HDD Module Disassembly	M2*5	2	86.PWL02.006
WLAN Module Disassembly	M2*3	1	86.PWL02.002
TV Tuner Module Disassembly	M2*3	1	86.PWL02.002
Slave HDD Module Disassembly	M2*5	2	86.PWL02.006
Slave HDD Door Disassembly	M2.5*6	2	86.PWL02.003
ODD Module Disassembly	M2.5*6	1	86.PWL02.003
ODD Bracket Disassembly	M2*3	2	86.PWL02.002
Keyboard Module Disassembly	M1.6*1.35	6	86.PWL02.004

Step	Screw	Quantity	Part No.
Lower Cover Disassembly	M2.5*6	16	86.PWL02.003
	M2.5*2.3	2	TBD

Removing the Battery Pack

1. Turn the computer over.
2. Slide the battery lock/unlock latch to the unlock position.

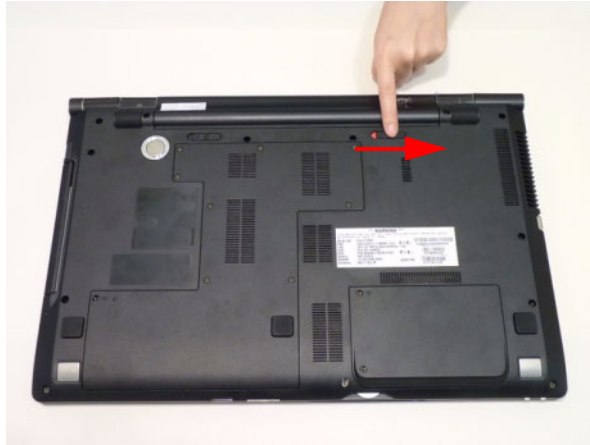

3. Slide and hold the battery release latch to the release position (1), then slide out the battery pack from the main unit (2).

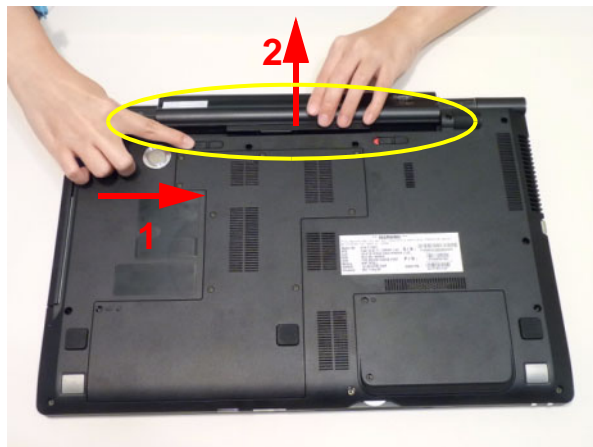

 **NOTE:** The battery has been highlighted with a yellow oval as shown in the above image. Please detach the battery and follow local regulations for disposal.

Removing the Dummy Card

1. Press the dummy card in to allow it to spring out.



2. Pull the dummy card out.



Removing the Base Door

1. See “Removing the Battery Pack” on page 50.
2. Loosen the nine (9) captive screws.

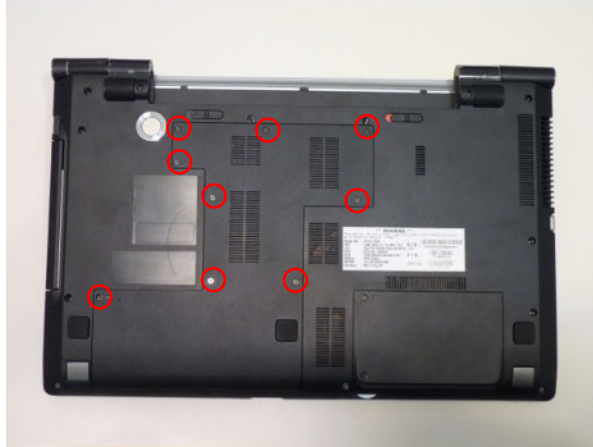

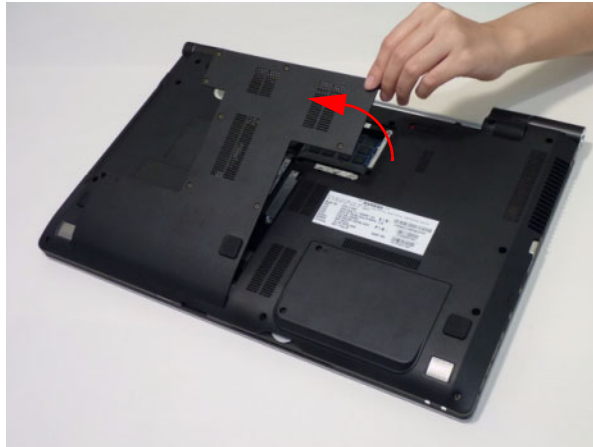

3. Lift the base door up at the finger indentation location provided in the bottom cover.

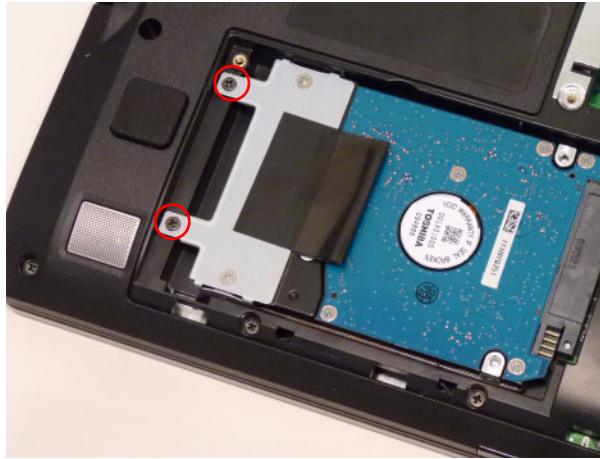

Removing the Hard Disk Drive Module

1. See "Removing the Base Door" on page 52.
2. Remove two (2) screws on the HDD connector.



Step	Screw	Quantity	Screw Type
Master HDD Module Assembly	M2*5	2	

3. Grasp the pull tab on the top of the HDD.

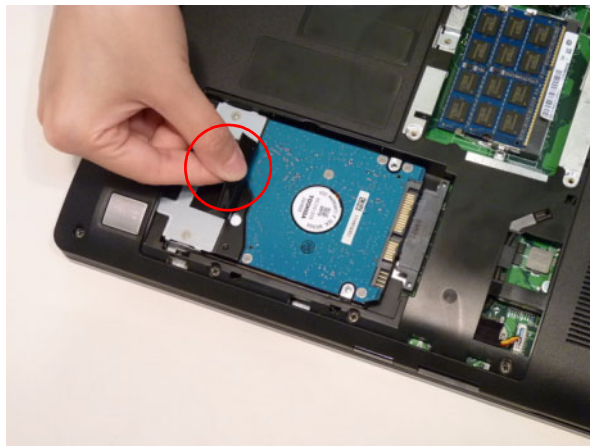

- Pull the tab horizontally to slide the HDD out of the connector dock.

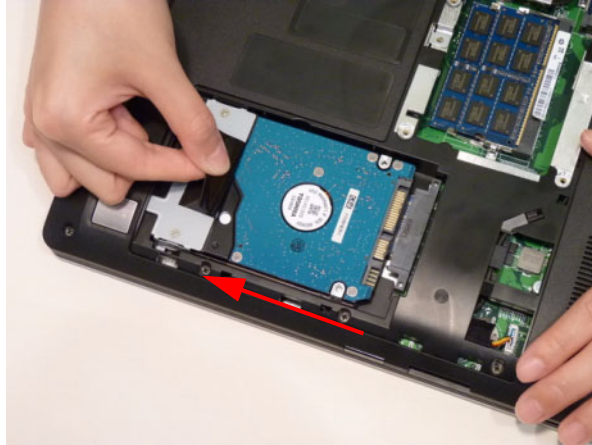

- Lift the HDD out.

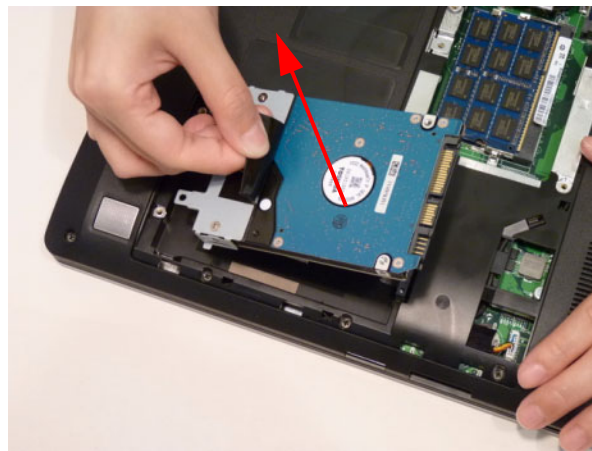

- Remove the two (2) screws from the HDD bracket.



Step	Screw	Quantity	Screw Type
Master HDD Bracket Disassembly	M3*3.5 Ni	2	

7. Lift the bracket away from the HDD.

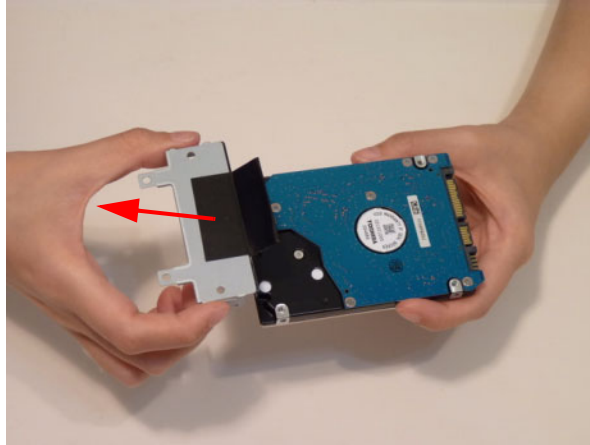

Removing the DIMM Module

1. See “Removing the Base Door” on page 52.
2. Push the memory module clips outwards.

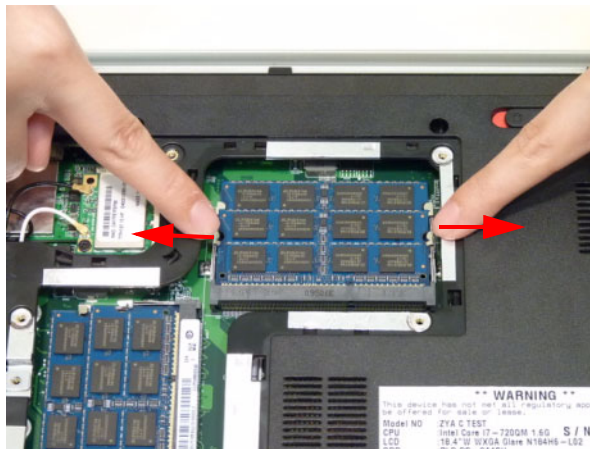

3. Pull the memory module out.

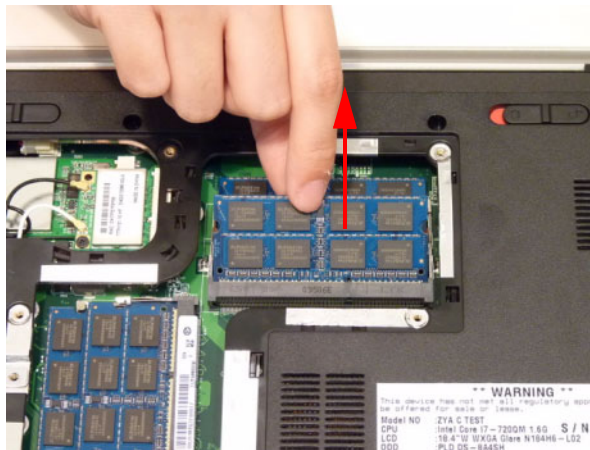

4. Repeat steps 2 and 3 for any remaining DIMM modules.

Removing the WLAN Module

1. See “Removing the Base Door” on page 52.
2. Detach the two (2) cables from the Wireless LAN module.

IMPORTANT: Take note of the Main (black) and Auxiliary (white) connector locations.

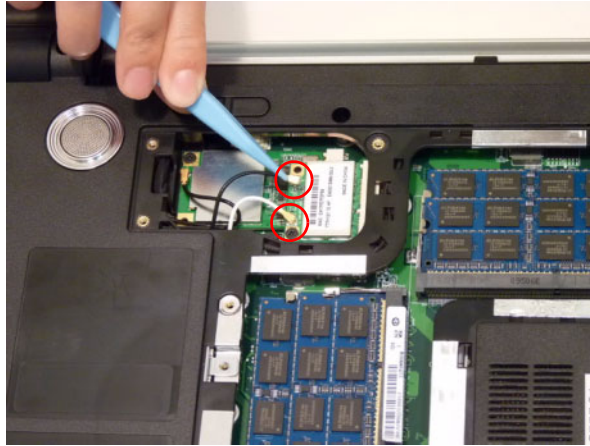

3. Remove the one (1) screw. Ensure the cables are well clear of the module.

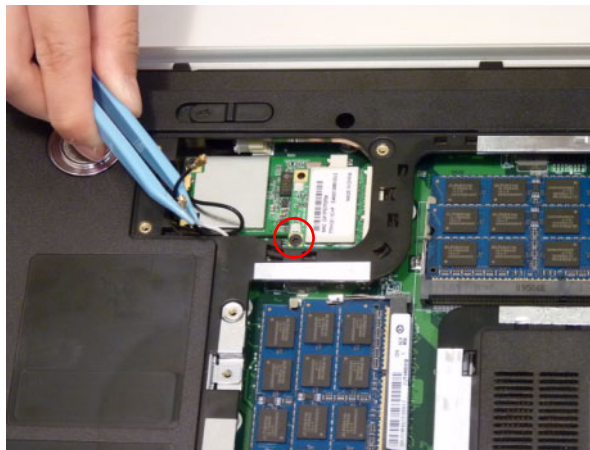

Step	Screw	Quantity	Screw Type
WLAN Module Disassembly	M2*3	1	

-
4. Pull the WLAN module out and away.

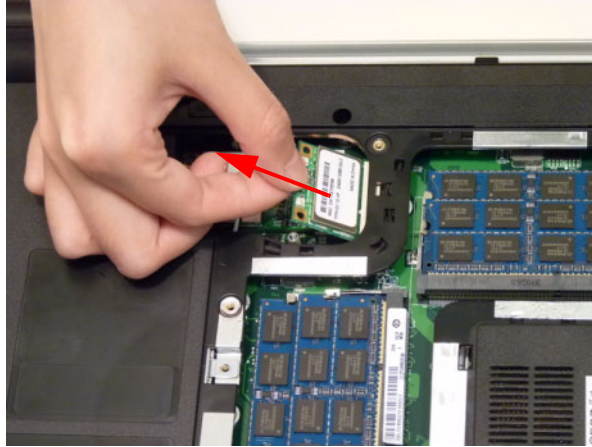

Removing the TV Tuner Module

1. See “Removing the WLAN Module” on page 56.
2. Detach the one (1) cable from the TV Tuner module.



3. Remove the one (1) screw. Ensure the cables are well clear of the module.



Step	Screw	Quantity	Screw Type
TV Tuner Module Disassembly	M2*3	1	

4. Make sure the antenna cables are clear of the board.



5. Pull the TV Tuner module out and away.

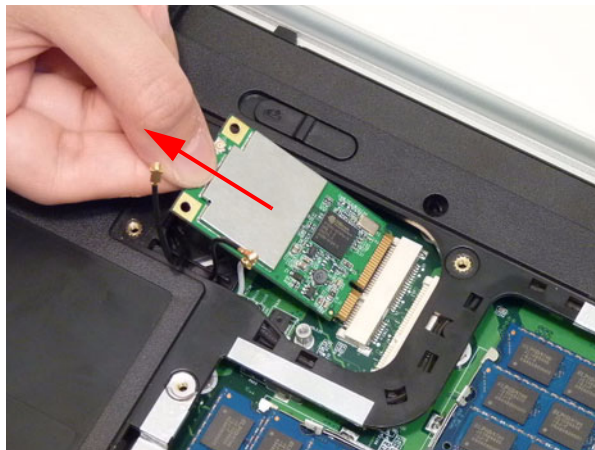

Removing the Slave HDD Module

1. See "Removing the Battery Pack" on page 50.
2. Remove the two (2) screws from the module door.



Step	Screw	Quantity	Screw Type
Slave HDD Door Disassembly	M2.5*6	2	

3. Lift the Slave HDD module door away.



- Remove two (2) screws from the HDD connector.



Step	Screw	Quantity	Screw Type
Slave HDD Module Assembly	M2*5	2	

- Grasp the pull tab on the Slave HDD module and slide the HDD in the direction of the arrow.



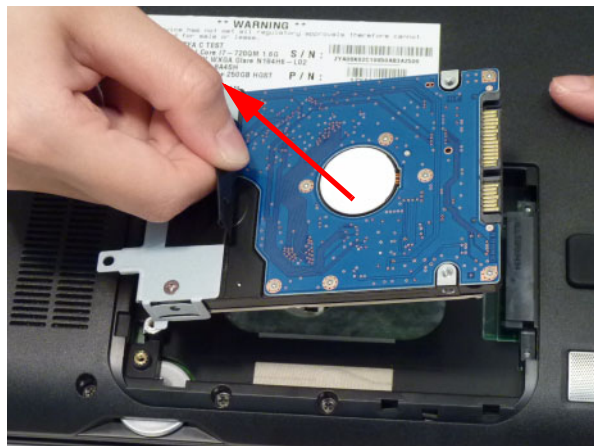

- Lift the Slave HDD clear of the chassis.

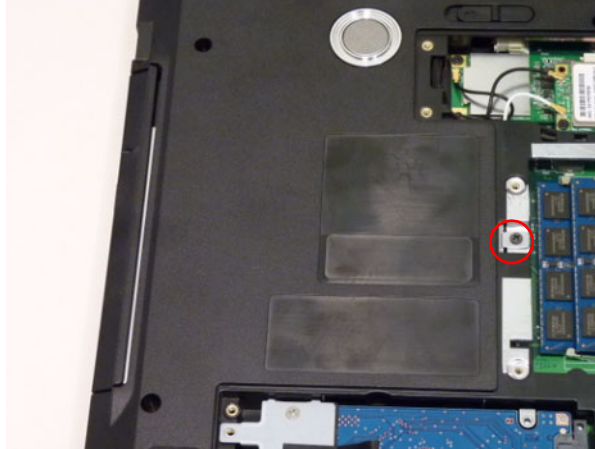

Removing the ODD Module

1. See "Removing the Base Door" on page 52.
2. Remove one (1) screw from the ODD module.



Step	Screw	Quantity	Screw Type
ODD Module Disassembly	M2.5*6	1	

3. Pull the ODD completely out of the bay.

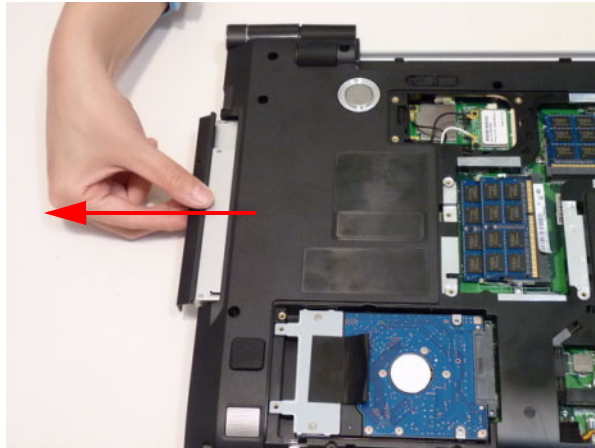

4. Remove the two (2) screws from the ODD bracket.



Step	Screw	Quantity	Screw Type
ODD Bracket Disassembly	M2*3	2	

5. Remove the ODD bracket.

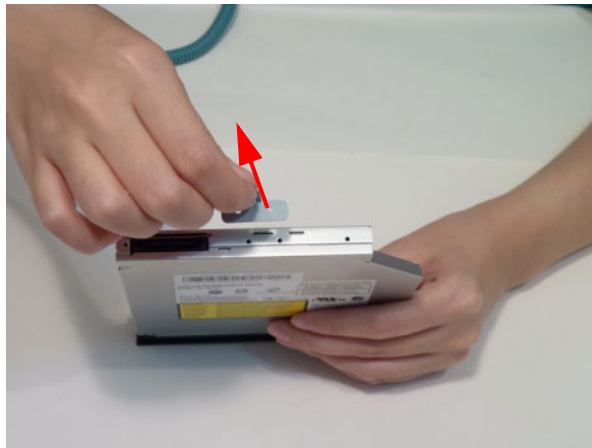

6. Pry the ODD bezel off the ODD module.

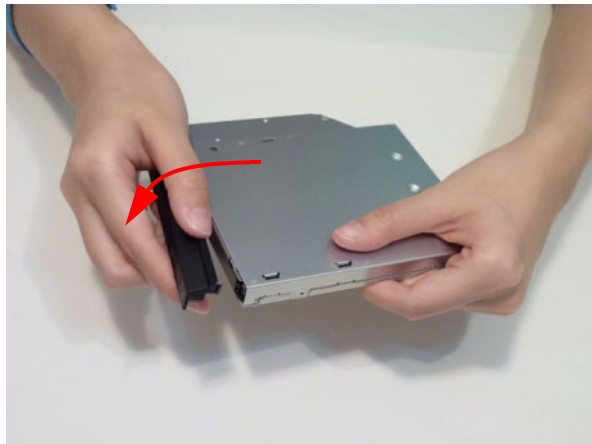



Removing the Keyboard

IMPORTANT: The keyboard is easily warped or damaged during the removal process. Take care not to use excessive force when removing to prevent damage.

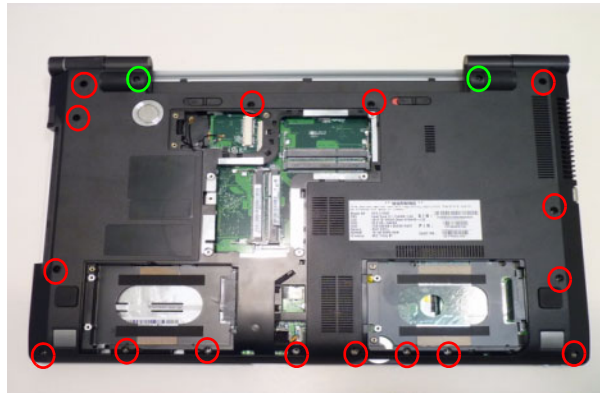
1. See "Removing the Battery Pack" on page 50.
2. Remove the eighteen (18) screws from the lower cover.



Step	Screw	Quantity	Screw Type
Lower Cover Disassembly	M2.5*6 (red callout)	16	
	M2.5*2.3 (green callout)	2	

3. Turn the computer over. Lift up the keyboard, starting from the top edge.



4. Carefully flip the keyboard over.



5. Detach the keyboard FPC.

a. Unlock the FPC

b. Disconnect the cable.

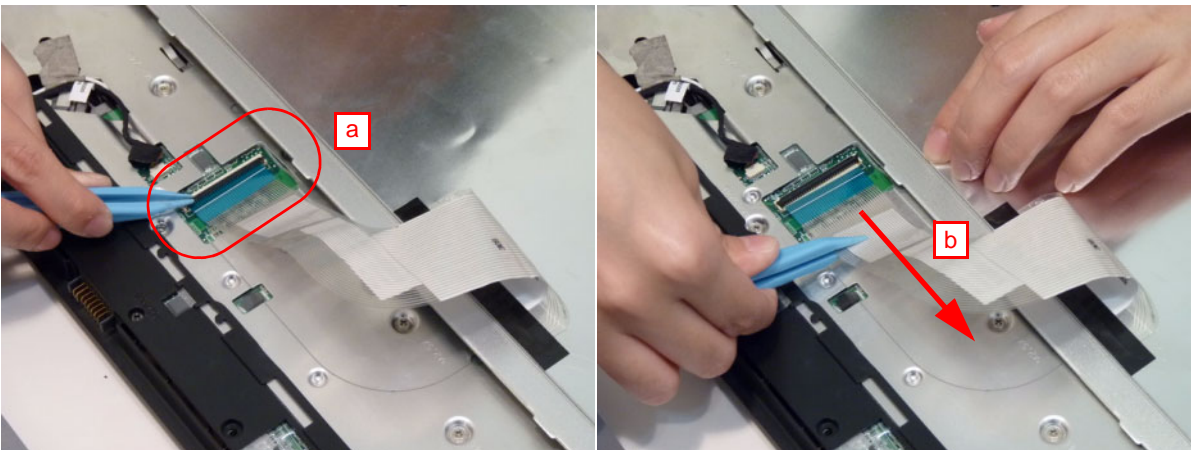

6. Remove the six (6) screws from the keyboard module to detach it from the keyboard frame.



Step	Screw	Quantity	Screw Type
Keyboard Module Disassembly	M1.6*1.35	6	

Main Unit Disassembly Process

IMPORTANT: Cable paths and positioning may not represent the actual model. During the removal and replacement of components, ensure all available cable channels and clips are used and that the cables are replaced in the same position.

NOTE: The product previews seen in the disassembly procedures may not represent the final product color or configuration.

Main Unit Disassembly Flowchart

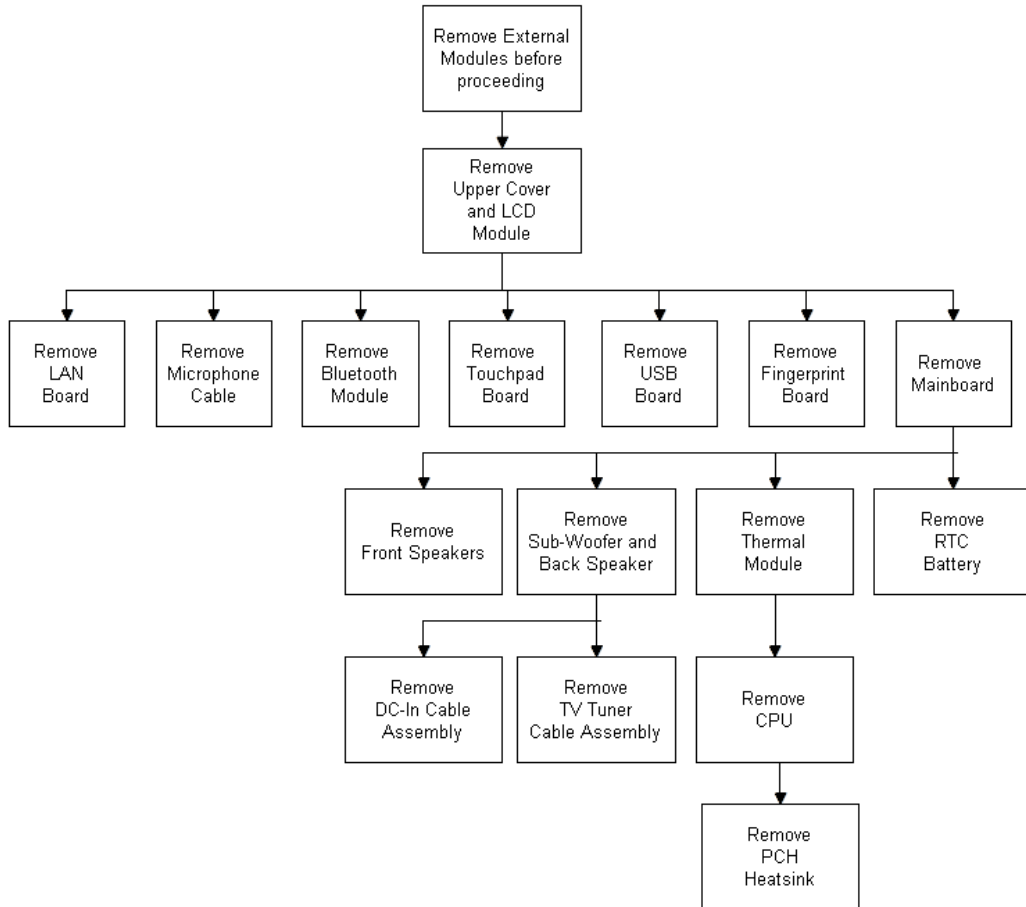

Main Unit Screw List

Step	Screw	Quantity	Part No.
Upper Cover Disassembly	M2.5*4	7	86.PWL02.010
	M2.5*6	6	86.PWL02.003
Microphone Set Disassembly	M2*3	1	86.PWL02.002
Bluetooth Module Disassembly	M2*3	1	86.PWL02.002
Touchpad Board Disassembly	M2-0.4*2	4	TBD
Finger Print Module Disassembly	M2*3	1	86.PWL02.002
LAN Module Disassembly	M2.5*6	1	86.PWL02.003
USB Module Disassembly	M2.5*6	1	86.PWL02.003
Mainboard Disassembly	M2.5*6	2	86.PWL02.003

Step	Screw	Quantity	Part No.
Thermal Module	M2.5*4	5	86.PWL02.010
Back Speaker Disassembly	M2.5*4	1	86.PWL02.010
Subwoofer Disassembly	M2.5*4	2	86.PWL02.010
Front Speaker Disassembly	M2.5*4	4	86.PWL02.010

Removing the Upper Cover and LCD Module

1. See “Removing the Keyboard” on page 63.
2. Disconnect the power board cable and free it from the securing clips.

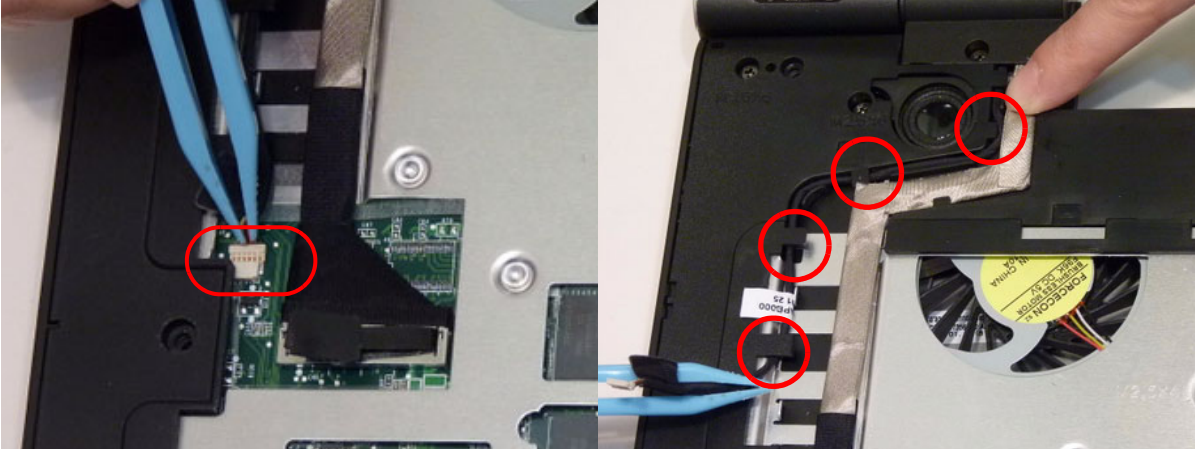

3. Pull up on the LVDS cable to release it from the connector.

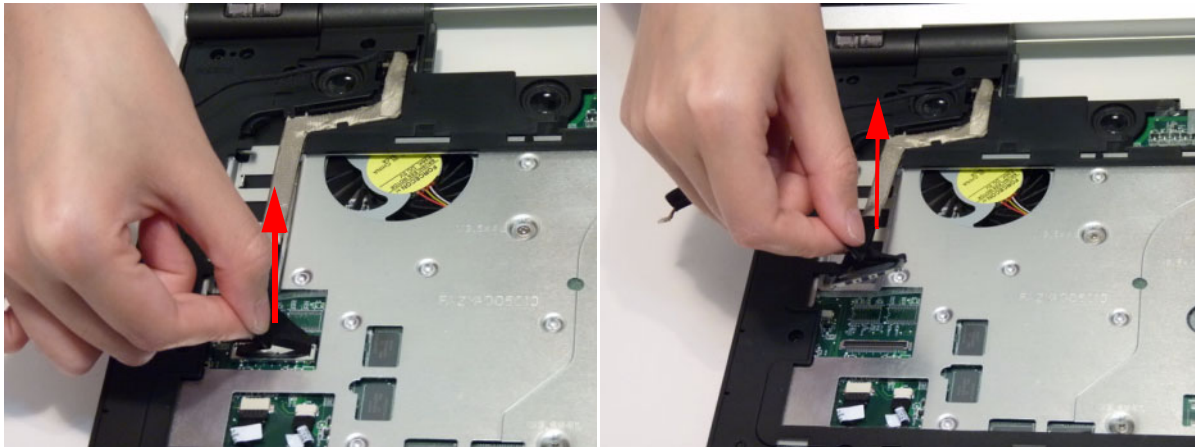

4. Unlock and disconnect the touchpad board FFC.

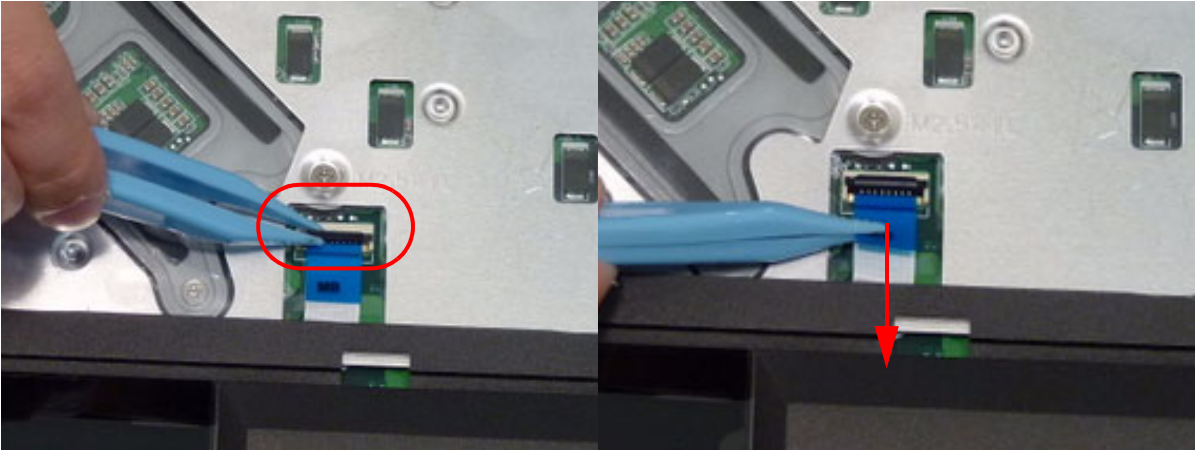

5. Unlock and disconnect the speaker cable.

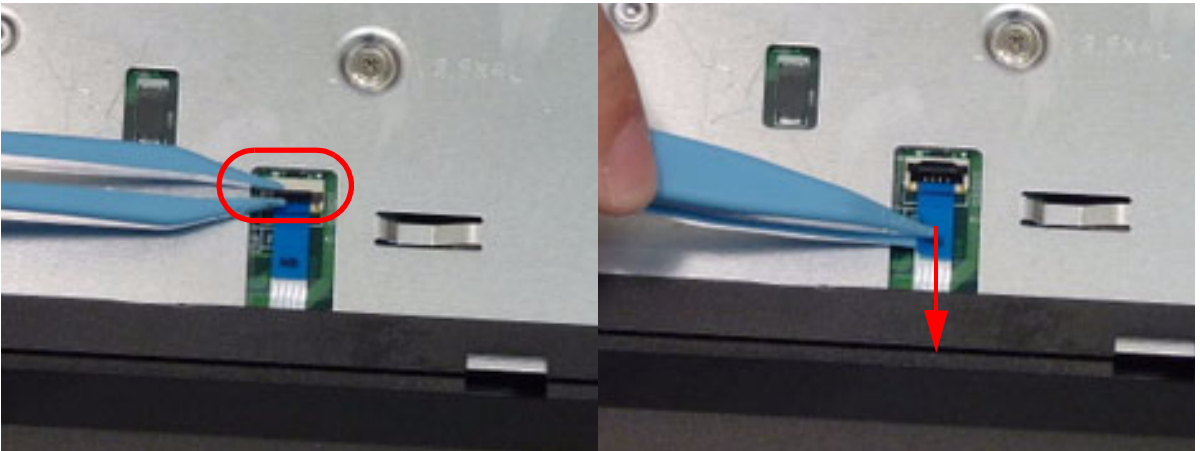

6. Disconnect and remove the power cable.

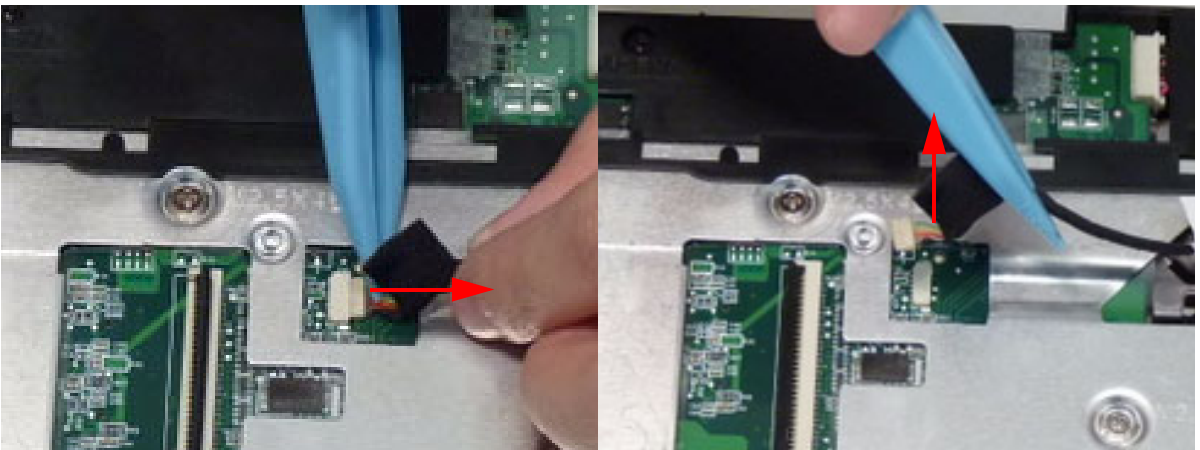

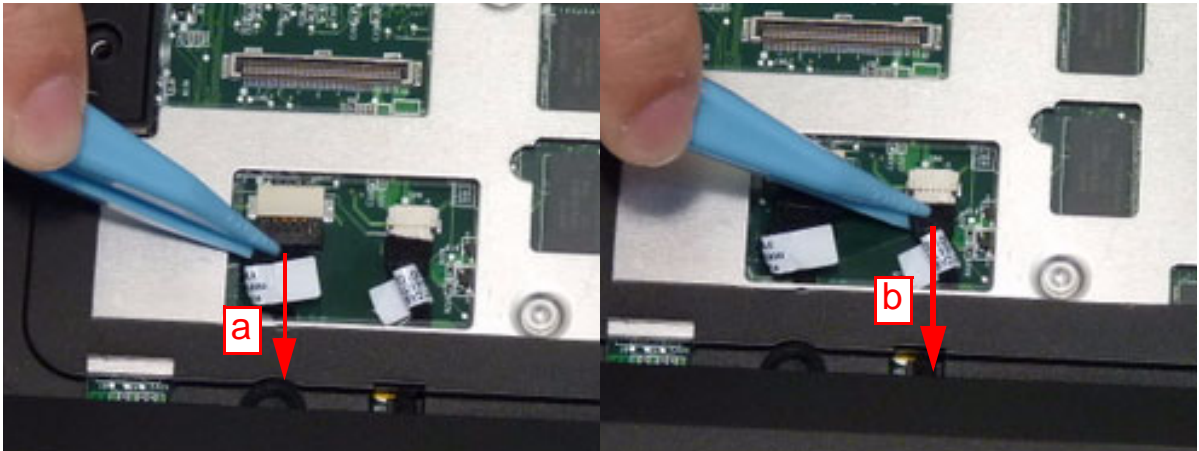

7. Disconnect the Bluetooth cable (a) and the microphone cable (b).

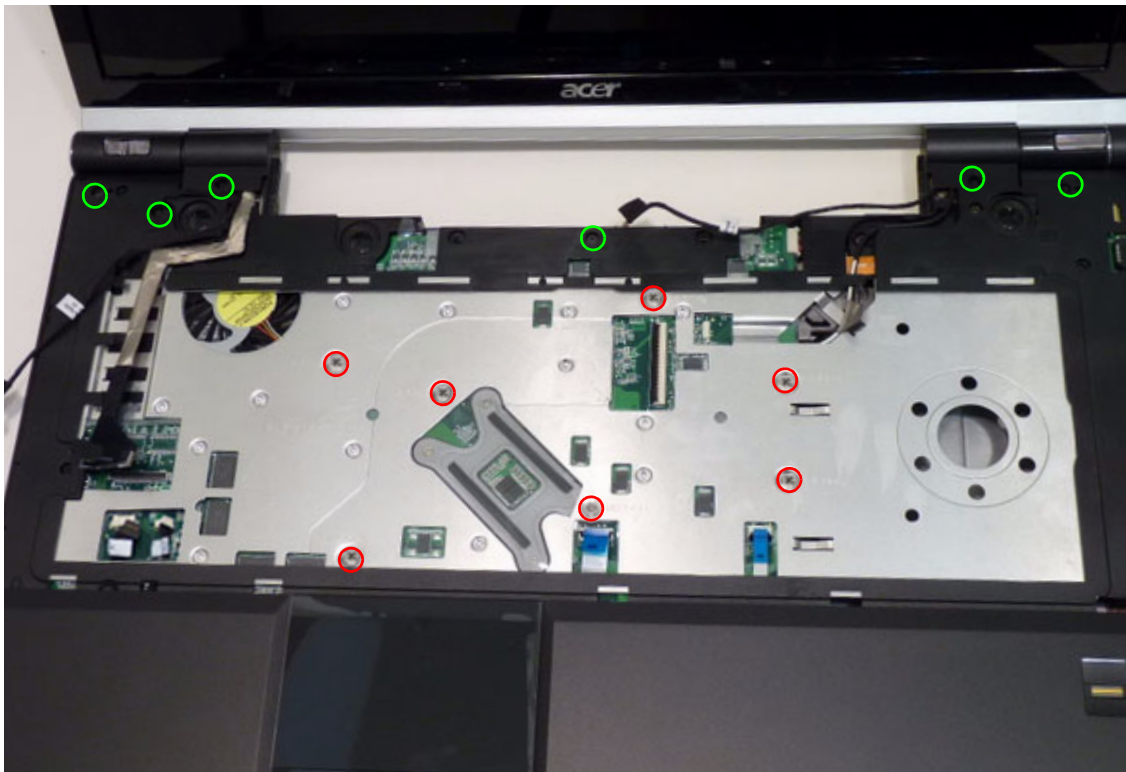

8. Remove the nineteen (19) screws from the upper cover and left and right hinges.



Step	Screw	Quantity	Screw Type
Upper Cover Disassembly (red callout)	M2.5*4	7	
Upper Cover Disassembly (green callout)	M2.5*6	6	

9. Remove the adhesive tape from the WLAN cable bundle.

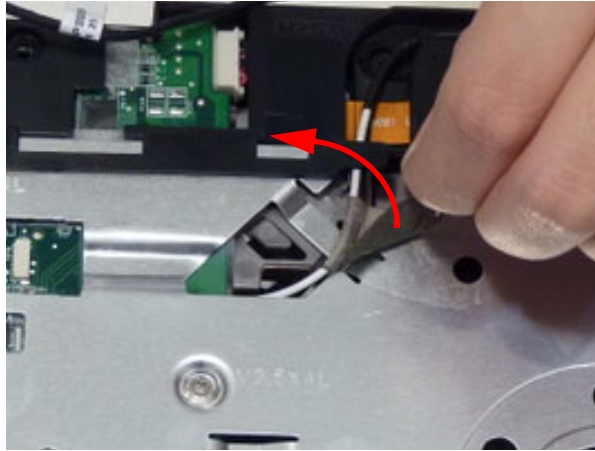

10. Pull the WLAN antenna up through the upper cover and free it from the cable channel.

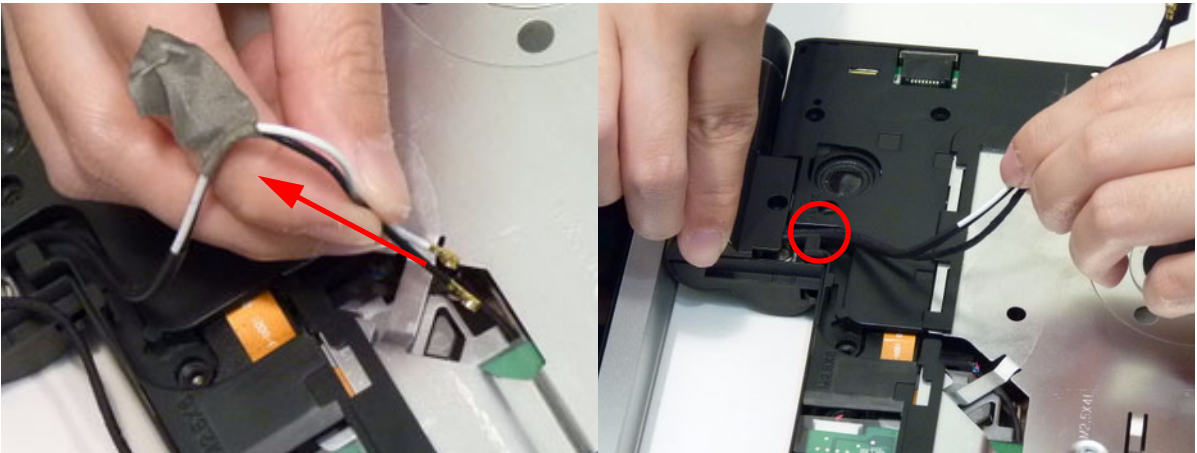

11. Remove the right hinge cap (a) and left hinge cap (b).

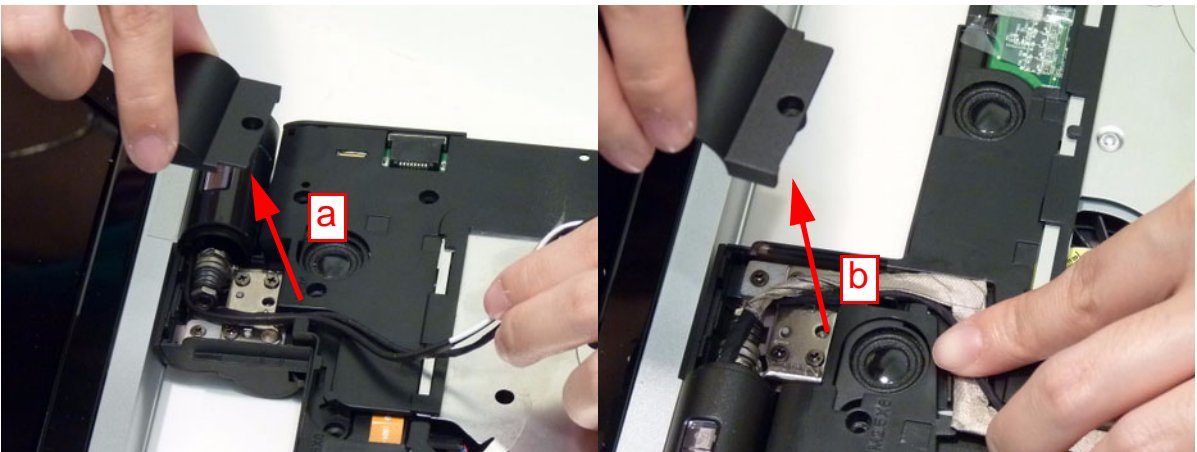

12. Remove the LCD module from the chassis.

CAUTION: Make sure all cables are pulled back and away from the device to avoid damage during removal.

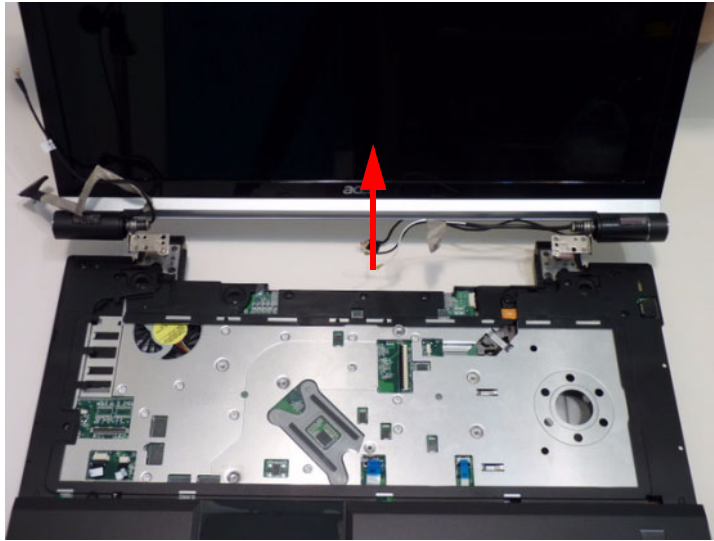

13. Lift the upper cover away from the lower cover, starting from the top edge as shown.



Removing the Microphone Cable

1. See "Removing the Upper Cover and LCD Module" on page 66.
2. Remove one (1) screw from the microphone cable.



Step	Screw	Quantity	Screw Type
Microphone Cable Disassembly	M2*3	1	

3. Lift the microphone cable clear of the upper cover.

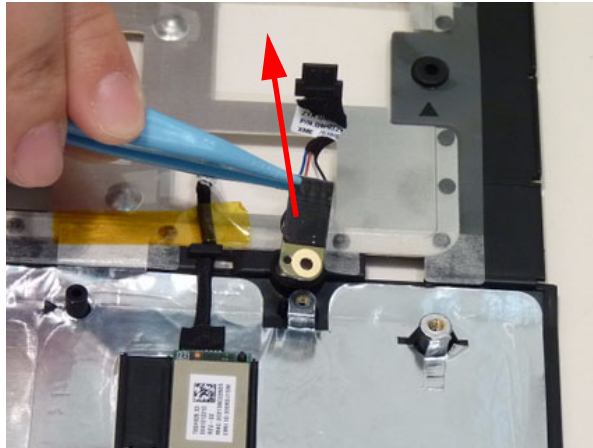

Removing the Bluetooth Module

1. See "Removing the Upper Cover and LCD Module" on page 66.
2. Remove the adhesive tape from the Bluetooth cable.

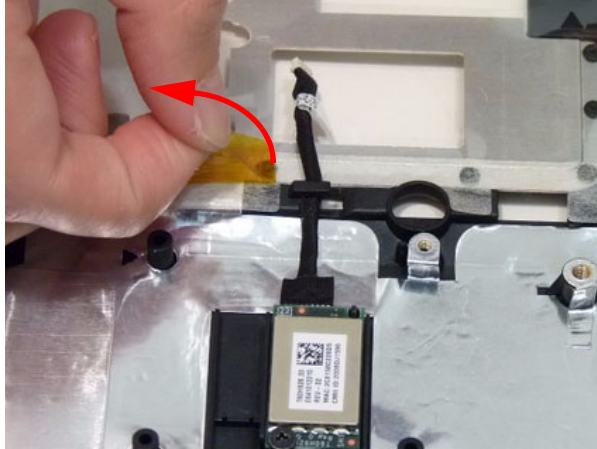

3. Free the Bluetooth cable from the cable clip.

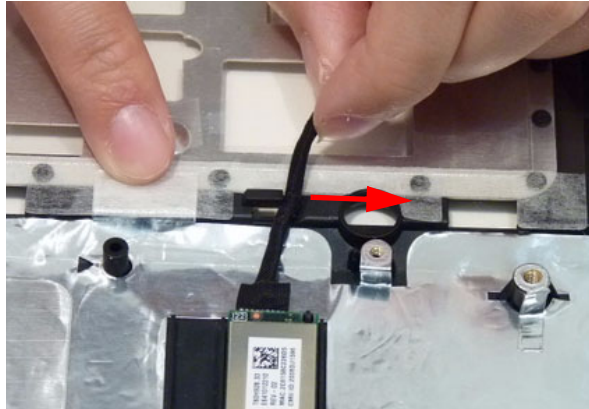

4. Remove one (1) screw from the Bluetooth module.



Step	Screw	Quantity	Screw Type.
Bluetooth Module Disassembly	M2*3	1	

-
5. Lift the Bluetooth module away from the upper cover.

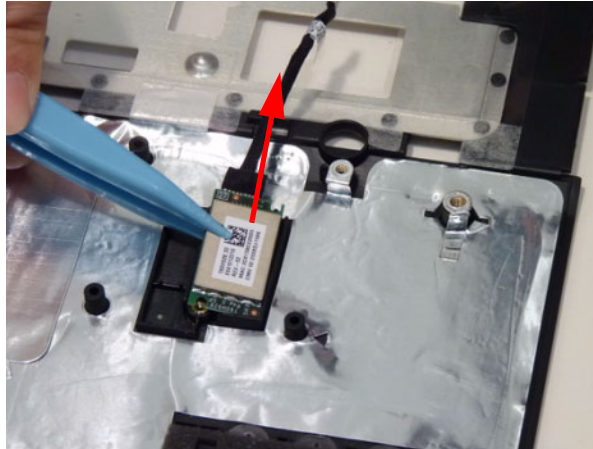

6. Disconnect the Bluetooth cable from the module.

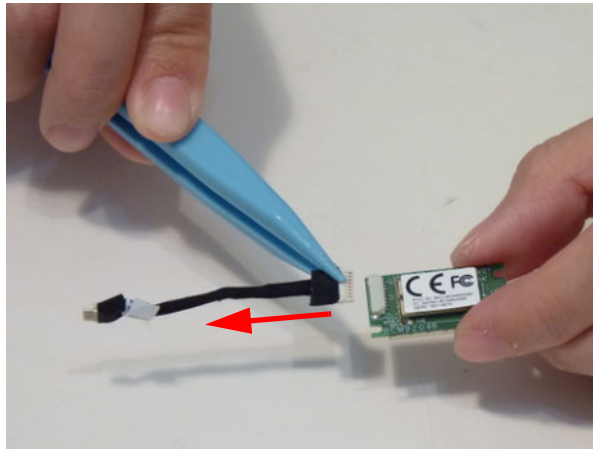

Removing the Mainboard to Touchpad Cable

1. See “Removing the Upper Cover and LCD Module” on page 66.
2. Turn the upper cover over and push the mainboard to touchpad cable through as shown.

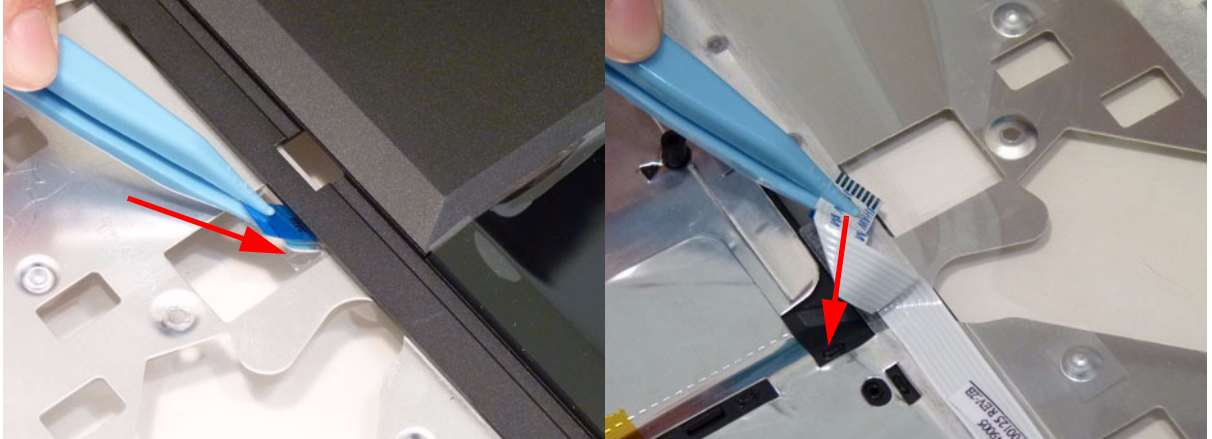

3. Remove the touchpad cable from the adhesive.

IMPORTANT: Take care not to tear the FFC during removal.

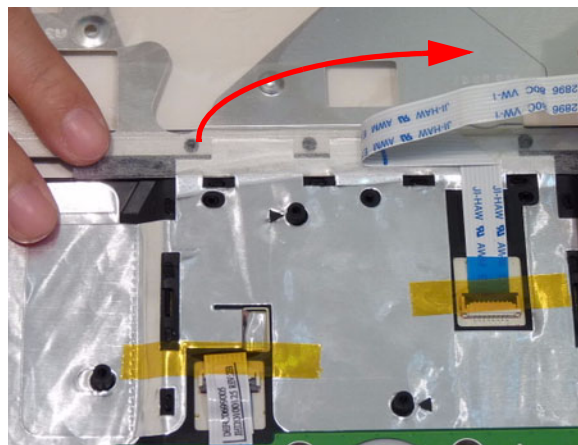

4. Peel back the adhesive tape on the connector.

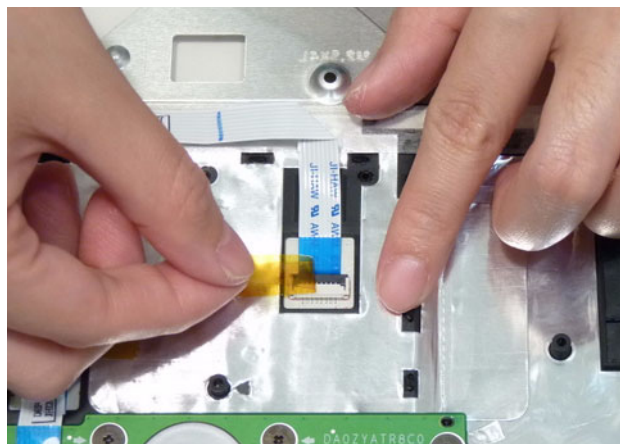

5. Unlock the connector and disconnect the cable.



Removing the Touchpad Module

IMPORTANT: It is not possible to remove the touchpad individually. If the touchpad malfunctions, follow the disassembly steps to remove any additional components on the upper cover and replace the entire upper cover.

1. See “Removing the Upper Cover and LCD Module” on page 66.
2. Peel back the adhesive tape securing the touchpad board cable.

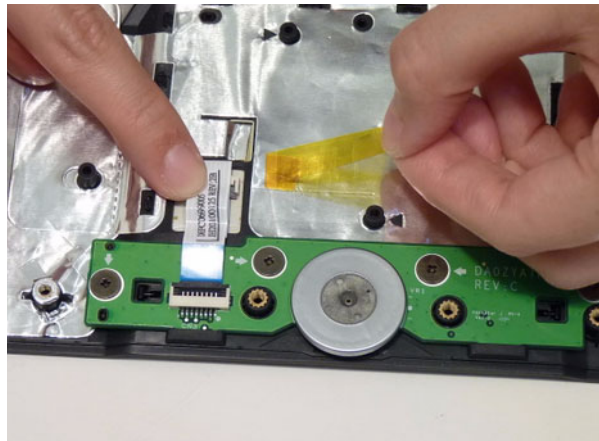

3. Unlock the connector and disconnect the cable.

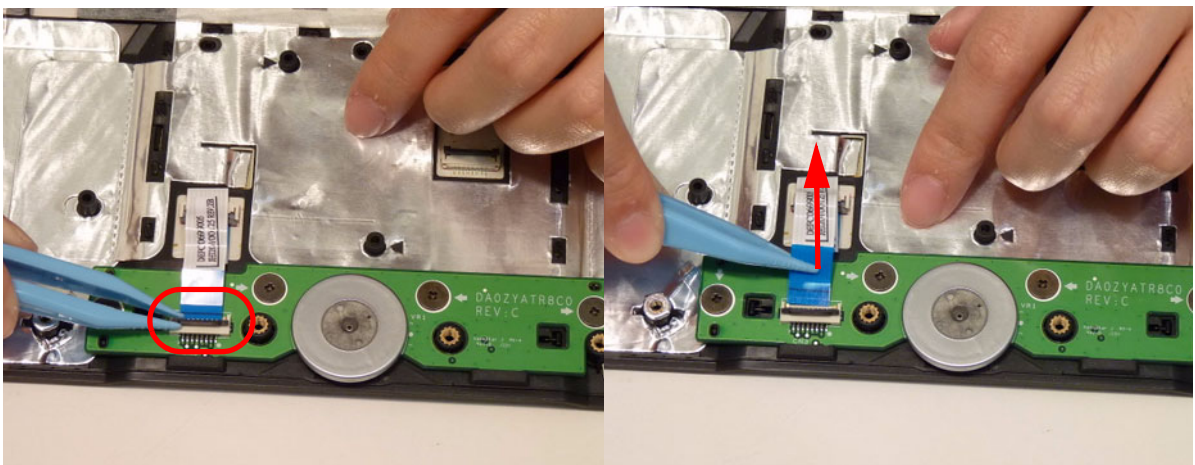

4. Unlock the connector securing the opposite end of the touchpad board cable.

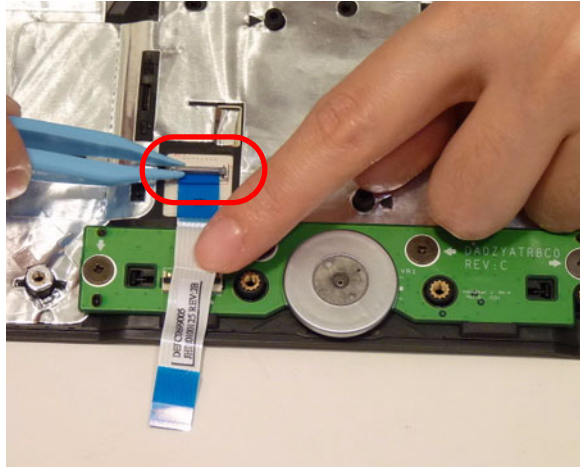

5. Remove the touchpad board cable from the upper cover.

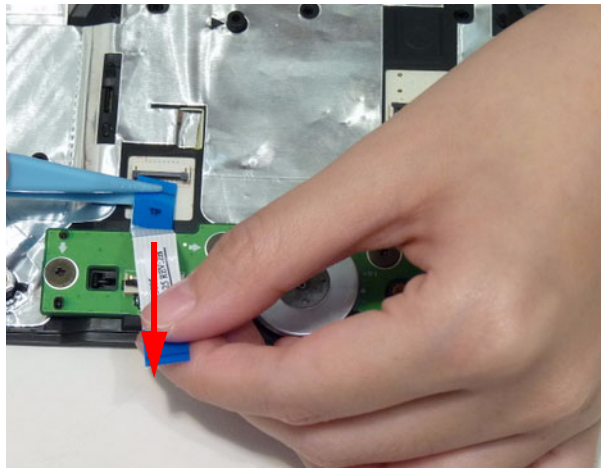

6. Remove four (4) screws from the touchpad board.

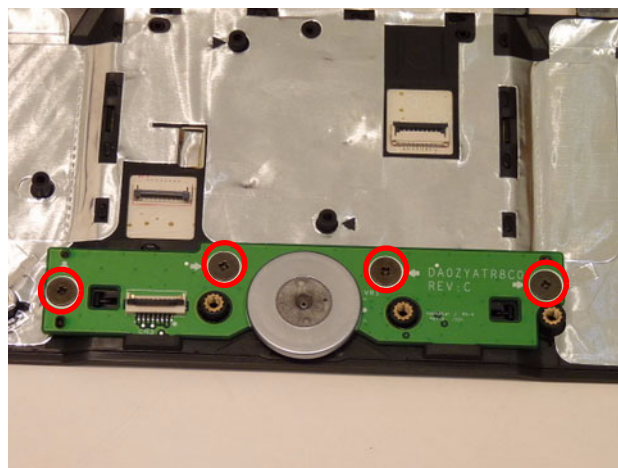

Step	Screw	Quantity	Screw Type.
Touchpad Module Disassembly	M2-0.4*2	4	

7. Lift the touchpad board clear of the upper cover by pivoting the board around the guide pin as shown.

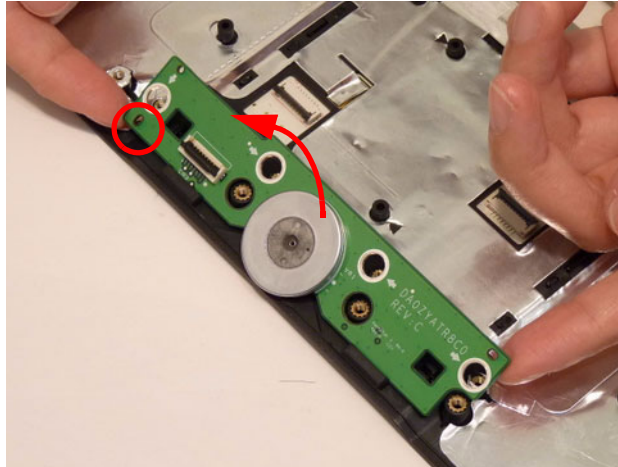

Removing the Finger Print Board

1. See "Removing the Upper Cover and LCD Module" on page 66.
2. Turn the upper cover over and pull the finger print cable through as shown.



3. Peel back the cable to free it from the adhesive.

IMPORTANT: Take care not to tear the FFC during removal.

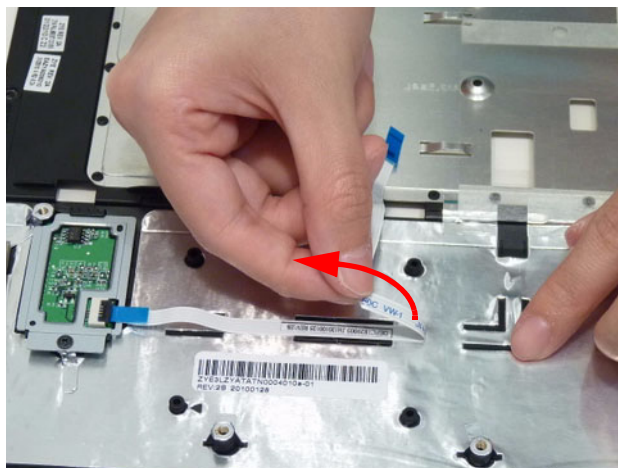

4. Unlock the connector and disconnect the cable.

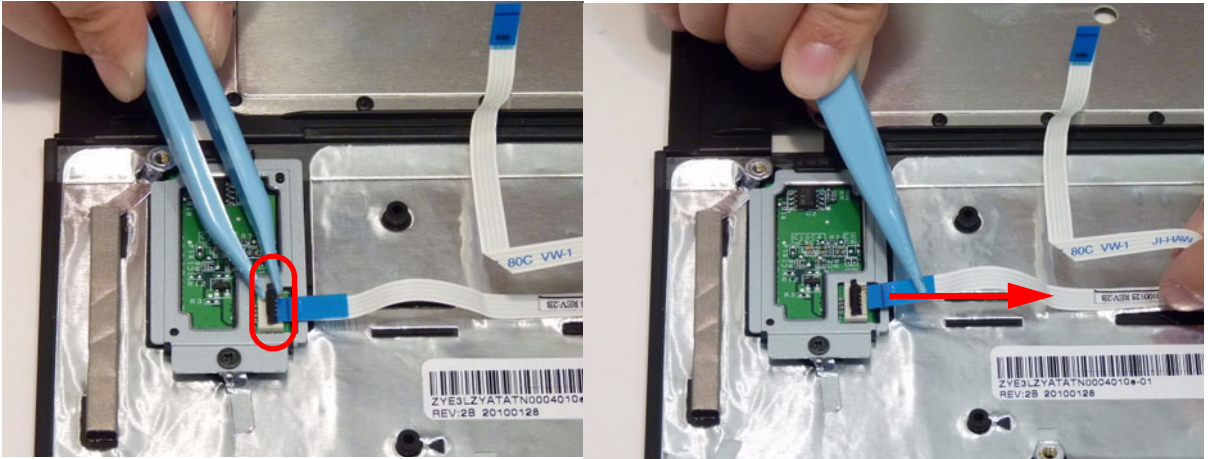

5. Remove one (1) screw from the finger print bracket.



Step	Screw	Quantity	Screw Type.
Finger Print Module Disassembly	M2*3	1	

6. Lift the finger print bracket clear of the upper cover.



7. Lift the finger print board clear of the upper cover.

CAUTION: Do not handle the finger print board with excessive force or else damage may occur.

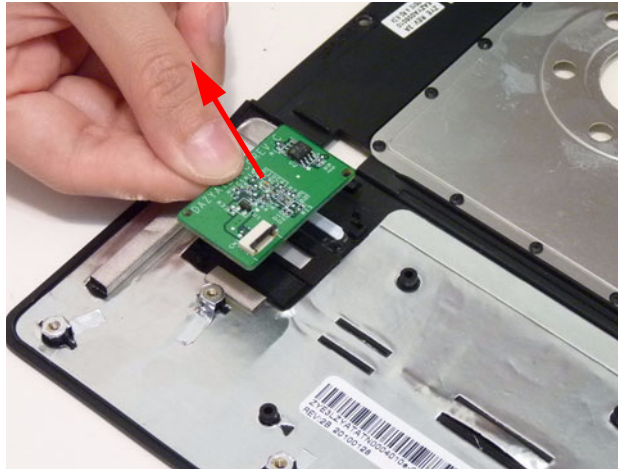

Removing the LAN Board

1. See "Removing the Upper Cover and LCD Module" on page 66.
2. Unlock the LAN board connector and disconnect the cable from the mainboard.

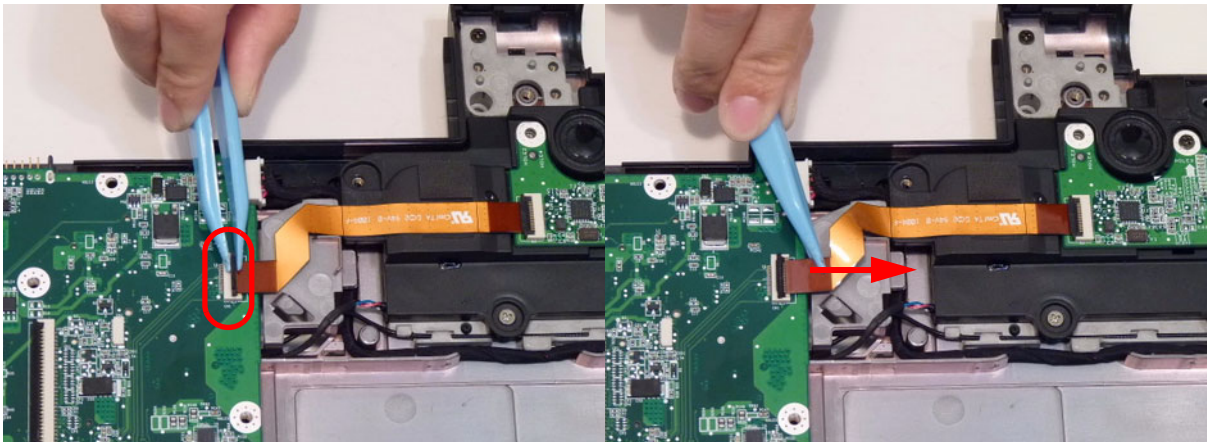

3. Peel the cable off the adhesive.

IMPORTANT: Take care not to tear the FFC during removal.

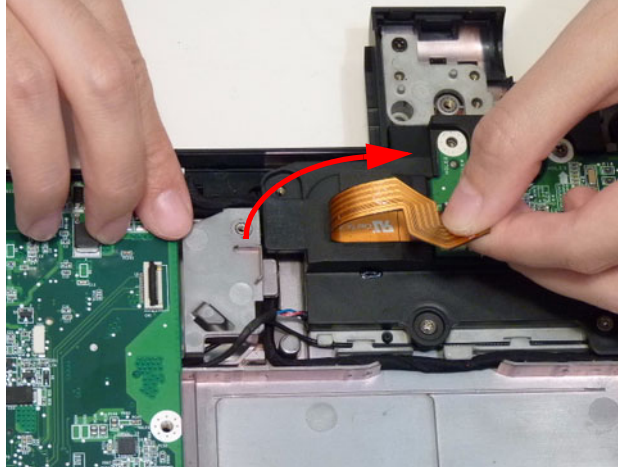

4. Unlock the LAN board cable connector and disconnect the cable from the LAN board.

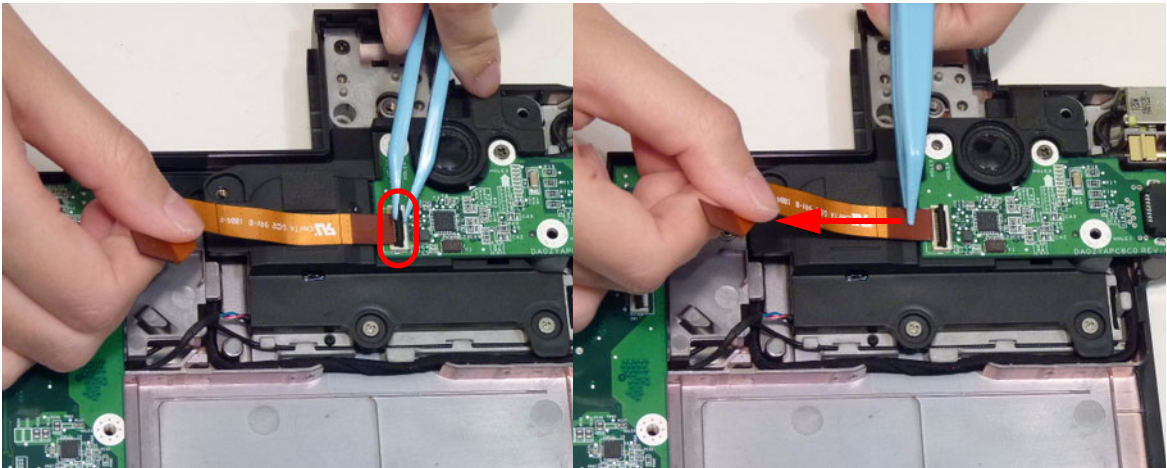

5. Remove one (1) screw from the LAN board.

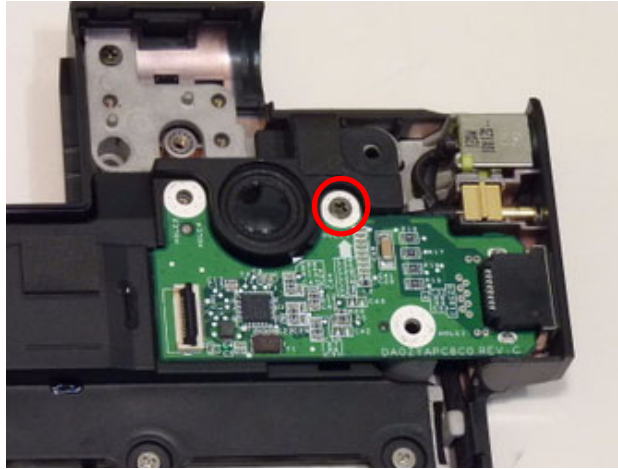

Step	Screw	Quantity	Screw Type.
LAN Module Disassembly	M2.5*6	1	

6. Lift the LAN board clear of the chassis.



Removing the USB Board

1. See “Removing the Upper Cover and LCD Module” on page 66.
2. Unlock the USB board connector and disconnect the cable from the mainboard.

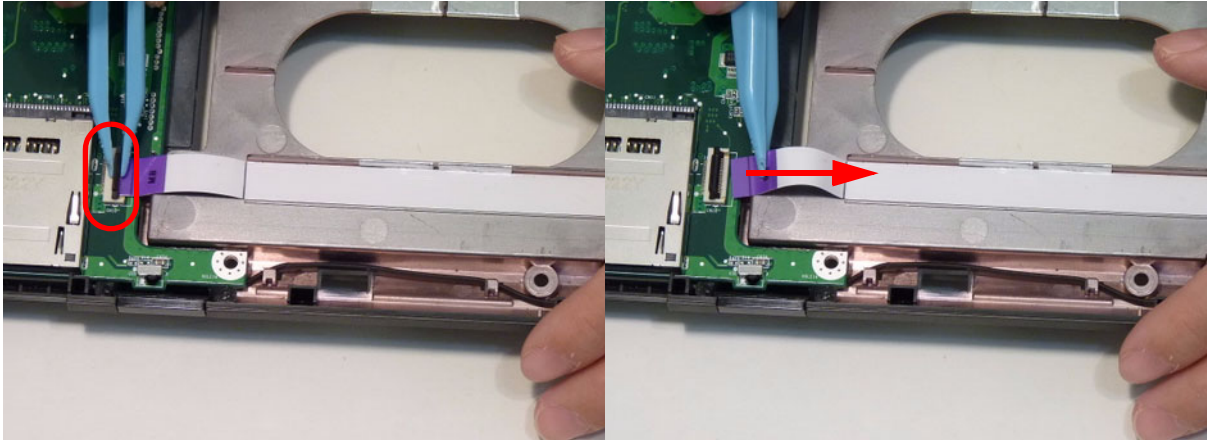

3. Peel the cable off the adhesive.

IMPORTANT: Take care not to tear the FFC during removal.

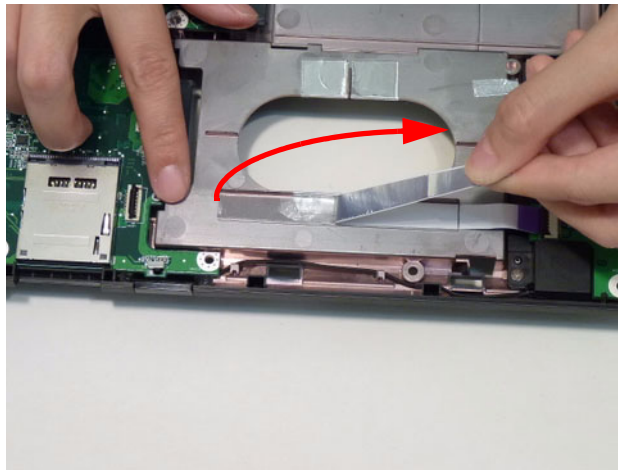

4. Unlock the USB board cable connector and disconnect the cable from the board.

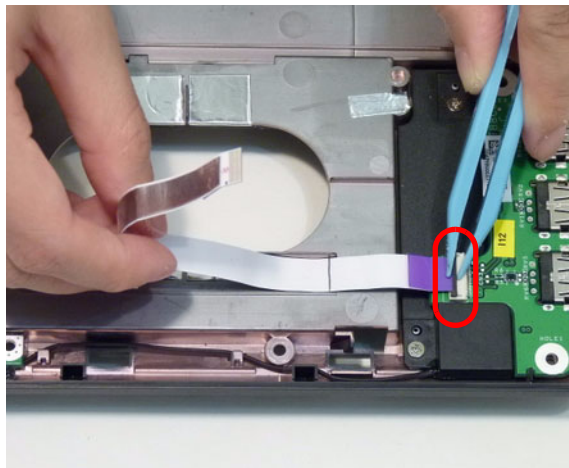

5. Remove one (1) screw from the USB board.

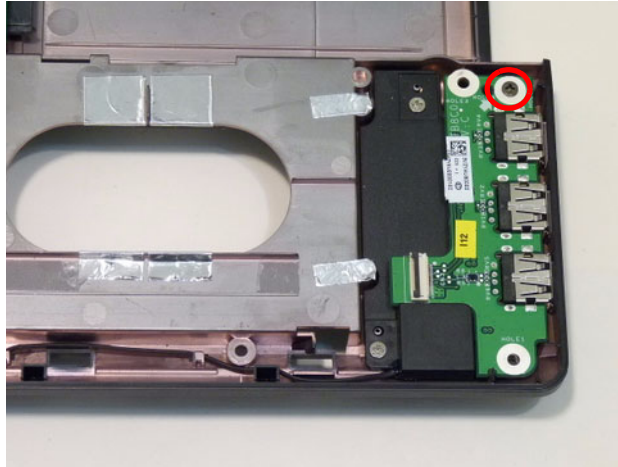

Step	Screw	Quantity	Screw Type.
USB Module Disassembly	M2.5*6	1	

6. Lift the USB board clear of the chassis.

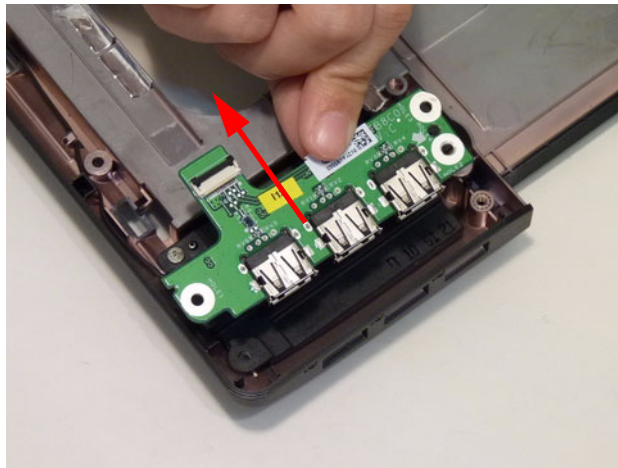

Removing the Mainboard

1. See “Removing the Upper Cover and LCD Module” on page 66.
2. Disconnect the following cables (a, b) from the mainboard.

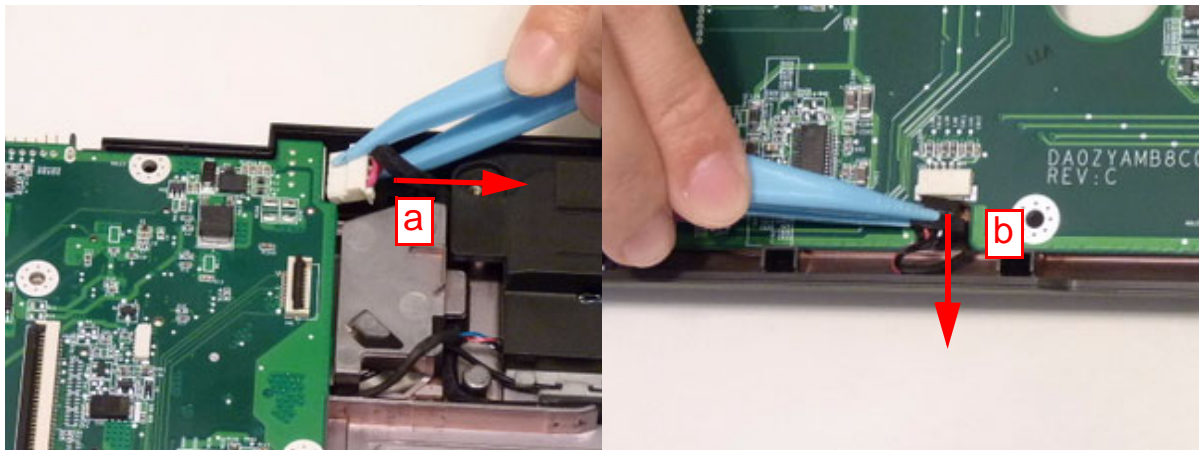
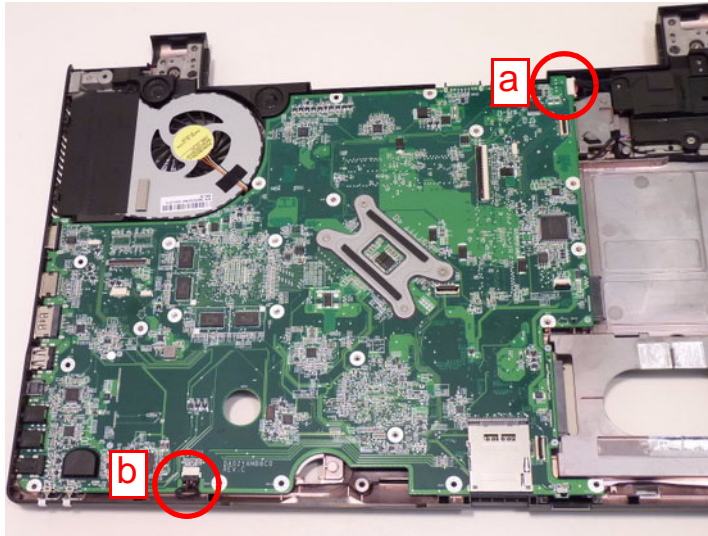

3. Turn the mainboard over and disconnect the final cable (c).

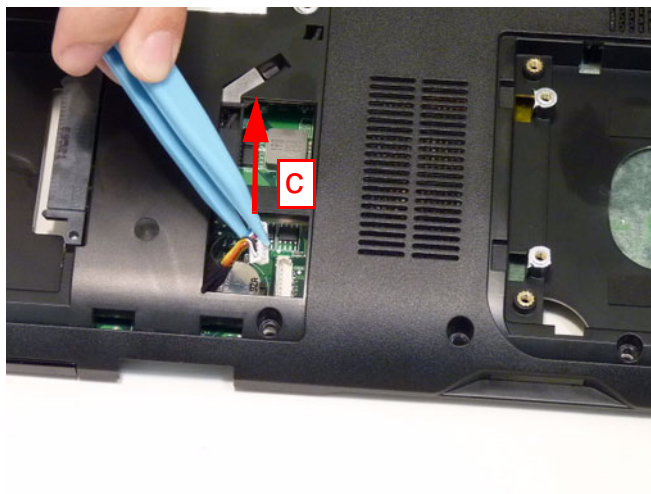

4. Remove two (2) screws from the mainboard.

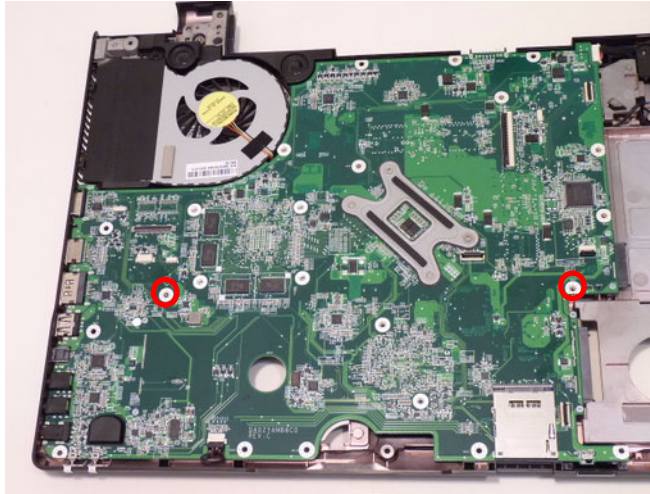

Step	Screw	Quantity	Screw Type.
Main Board Disassembly	M2.5*6	2	

5. Make sure all cables are clear of the mainboard. Lift the mainboard out of the chassis as shown.

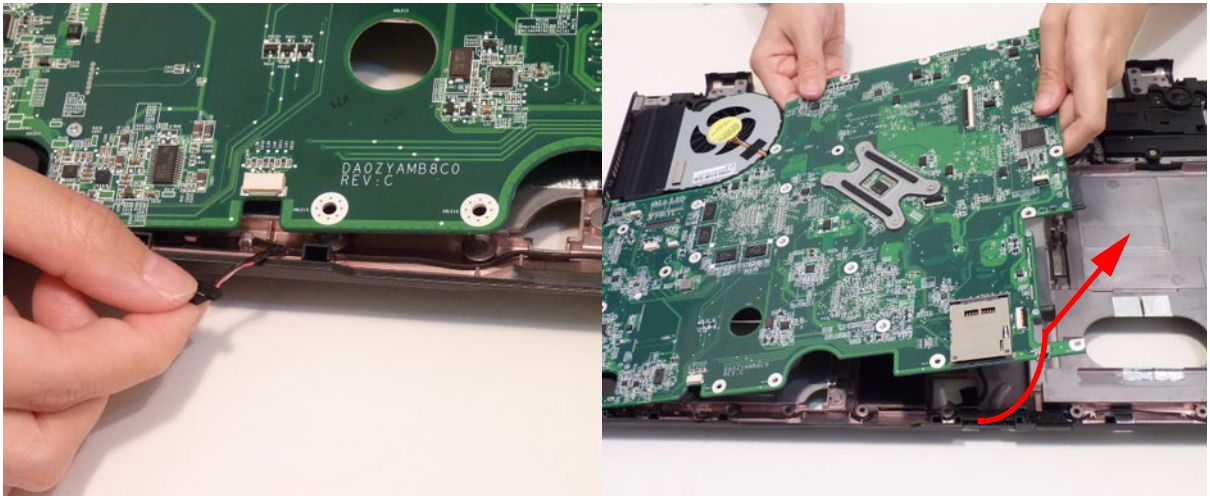

Removing the RTC Battery

1. See “Removing the Mainboard” on page 84.
2. Use a pair of plastic tweezers to pull the RTC battery off the mainboard.

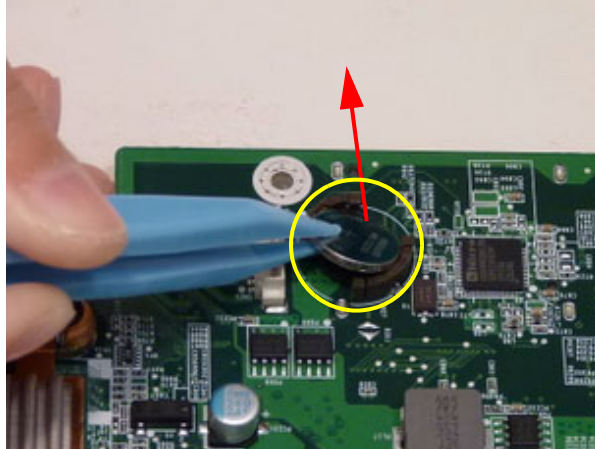

NOTE: The RTC battery has been highlighted with the yellow circle as shown in the previous image. Please detach the RTC battery and follow local regulations for disposal.

Removing the Thermal Module

1. See “Removing the Mainboard” on page 84.
2. Disconnect the thermal module fan connector.

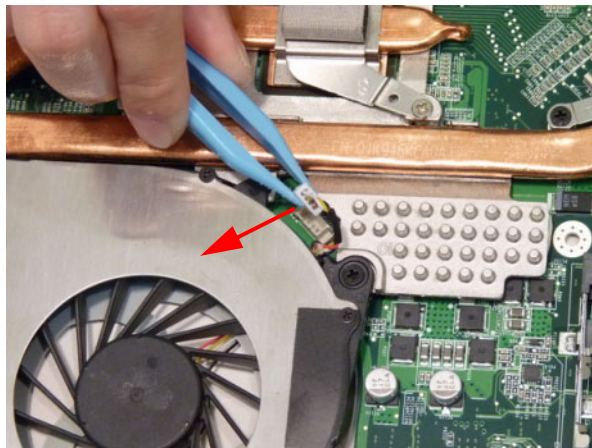

- Remove the five (5) non-captive screws (blue callouts) in reverse numerical order: 9, 8, 7, 6, 5. Loosen the four (4) captive screws (red callouts) in reverse numerical order: 4, 3, 2, 1.

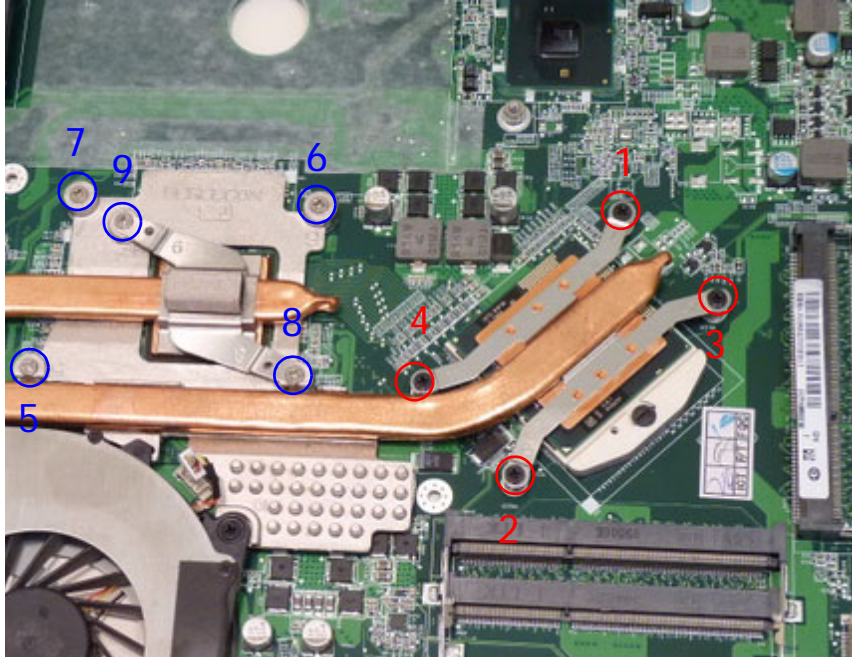

Step	Screw	Quantity	Screw Type.
Thermal Assy Screw (blue callouts)	M2.5*4 Ni	5	

- Lift the thermal module away from the mainboard.

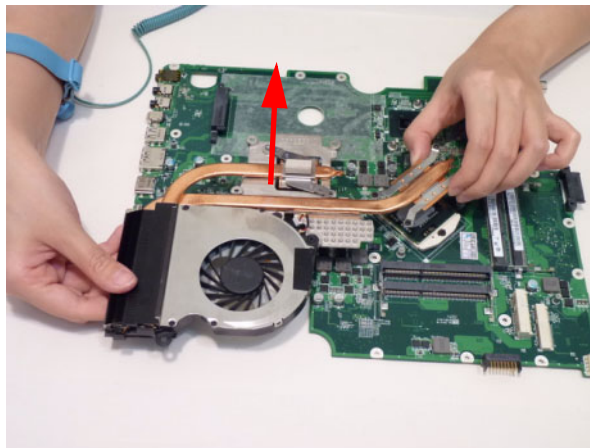

Removing the CPU

1. See “Removing the Thermal Module” on page 86.
2. Unlock the CPU. Use a standard screw driver to turn the screw 180°.

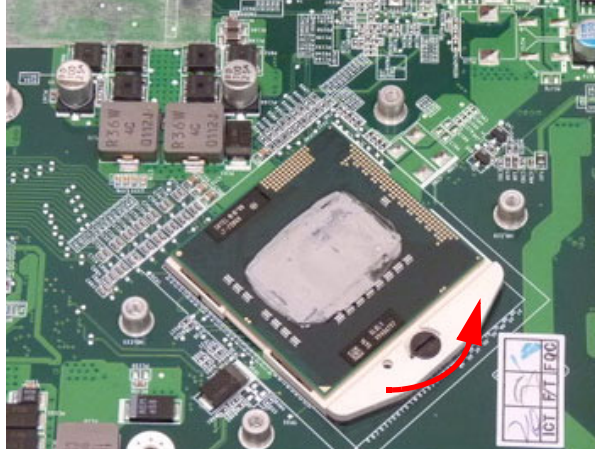

3. Lift the CPU out of the socket.

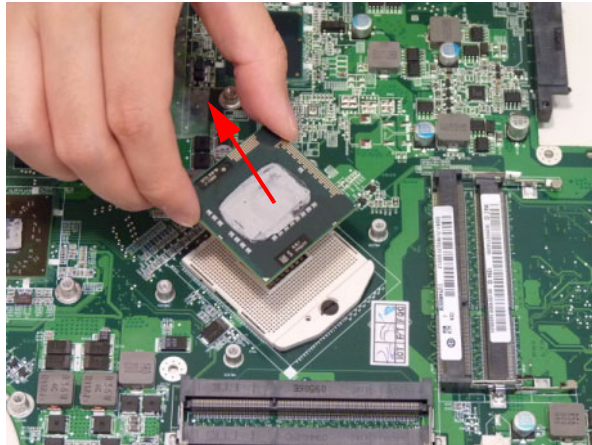

Removing the PCH Heatsink

1. See "Removing the Mainboard" on page 84.
2. Loosen the two (2) captive screws.

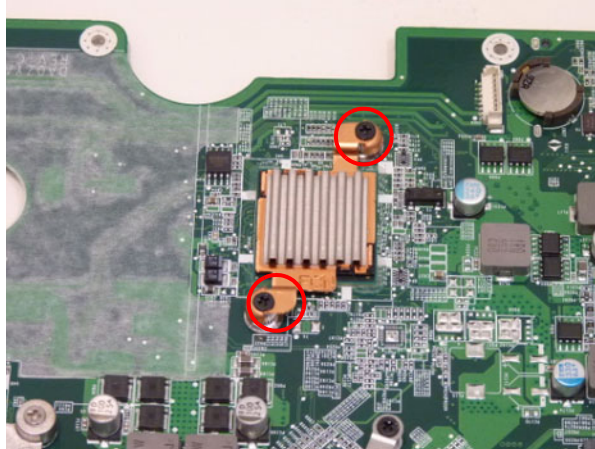

3. Lift the PCH heatsink away.

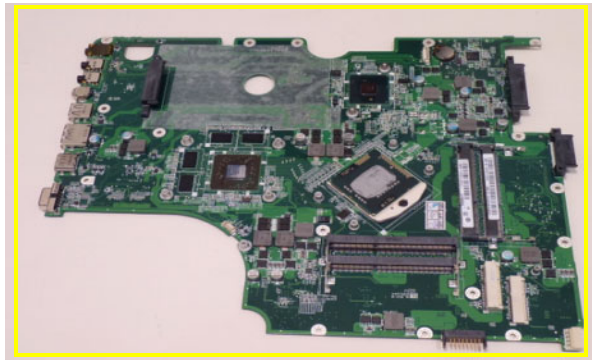
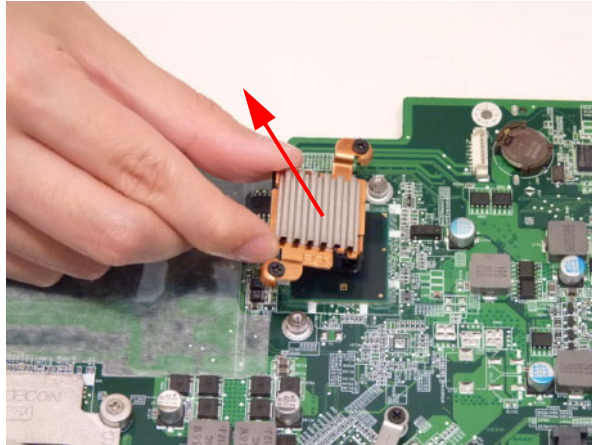

 **NOTE:** Circuit boards >10 cm² have been highlighted with a yellow rectangle as shown in the previous image. Please detach the circuit board and follow local regulations for disposal.

Removing the Subwoofer and Back Speaker

- 1. See "Removing the Mainboard" on page 84.
- 2. Free the cable assembly from the cable channel.

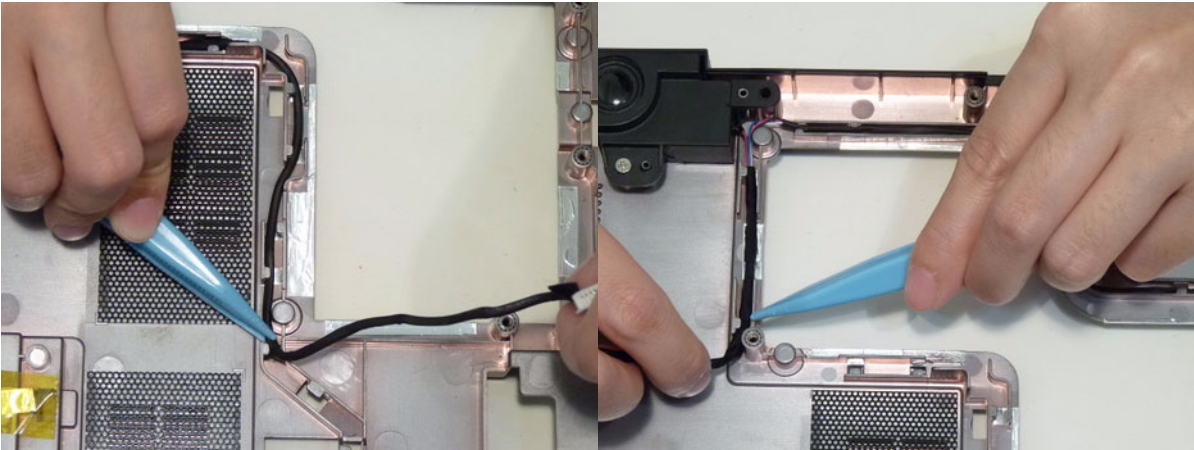
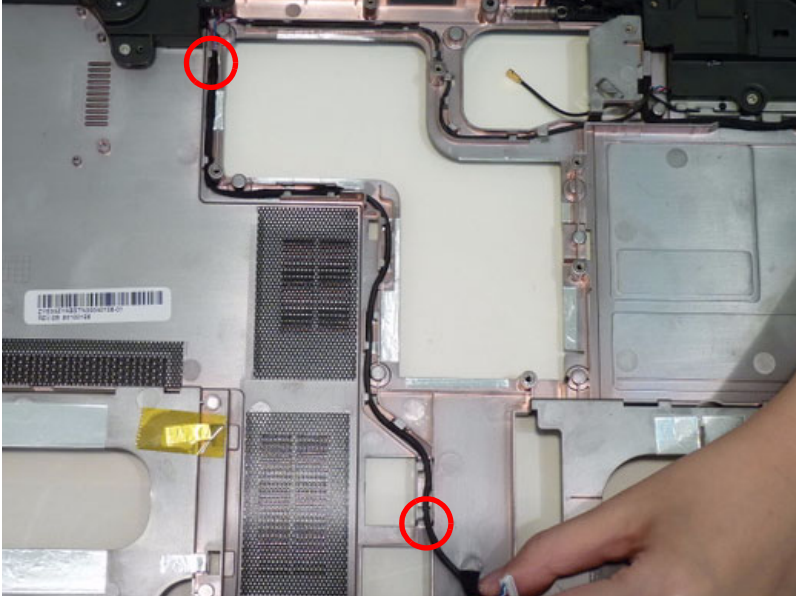

- Remove one (1) screw from the back speaker.

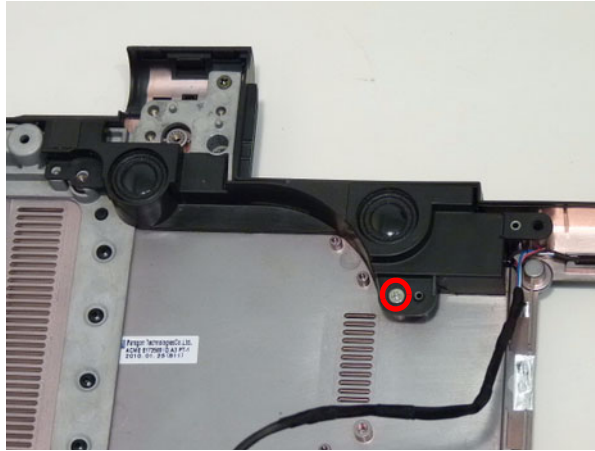

Step	Screw	Quantity	Screw Type.
Back Speaker Disassembly	M2.5*4	1	

- Lift the back speaker up from the chassis.

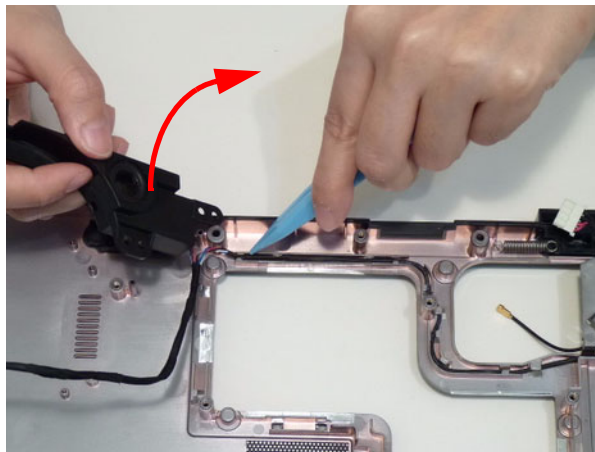

- Continue removing the speaker and cable from the channel as shown.

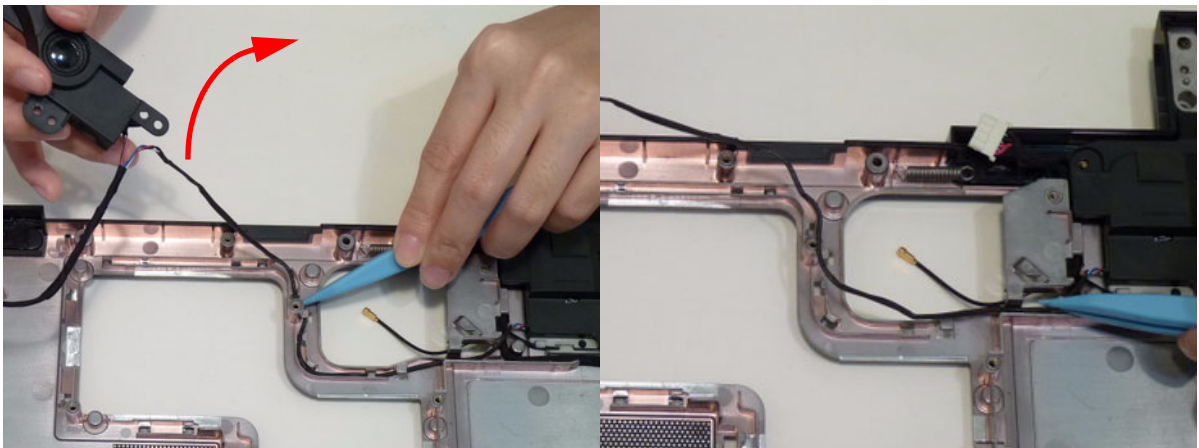

6. Remove two (2) screws from the subwoofer.

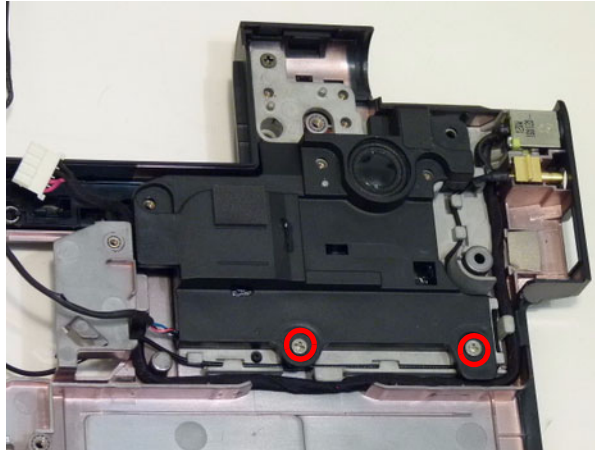

Step	Screw	Quantity	Screw Type.
Subwoofer Disassembly	M2.5*4	2	

7. Lift the subwoofer, back speaker, and cable assembly clear of the lower cover.

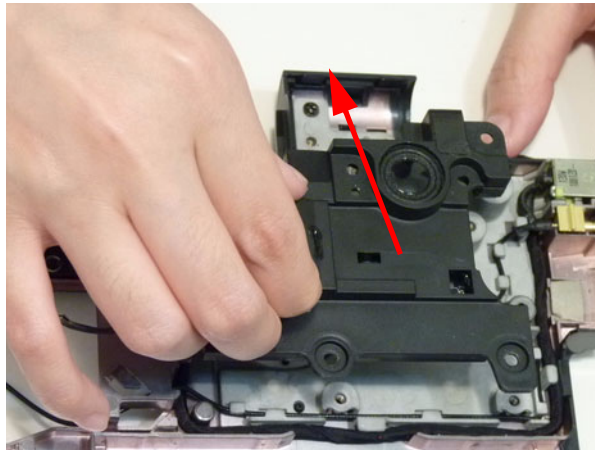

Removing the TV Tuner Cable Assembly

1. See "Removing the Subwoofer and Back Speaker" on page 90.
2. Pass the TV Tuner cable through the chassis as shown.

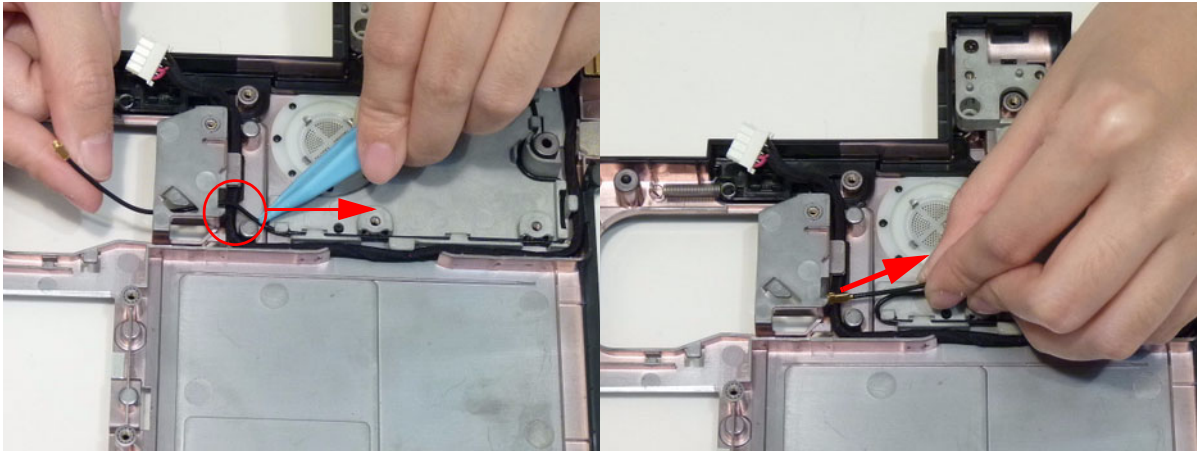

3. Remove the cable from the cable channel.

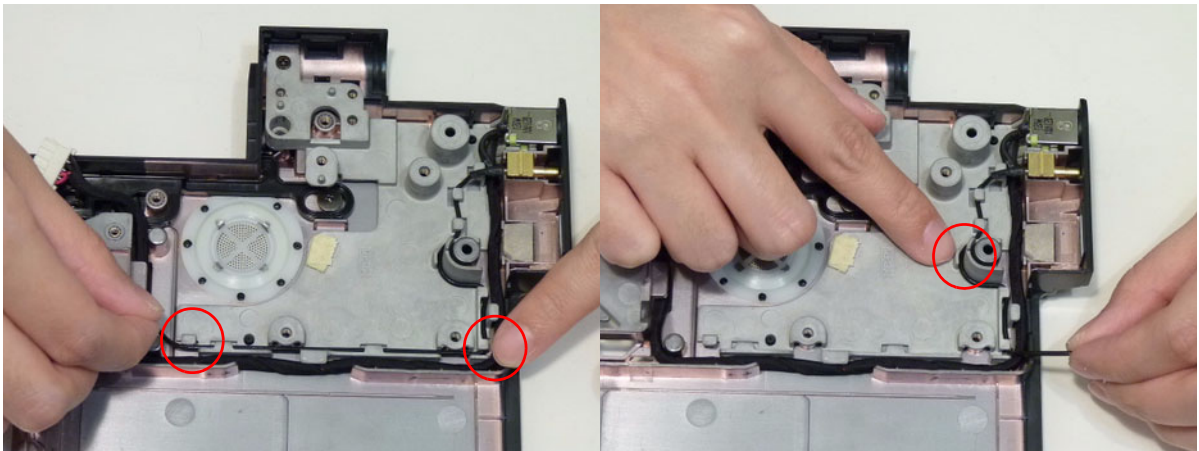

4. Lift the TV tuner assembly out of the chassis.

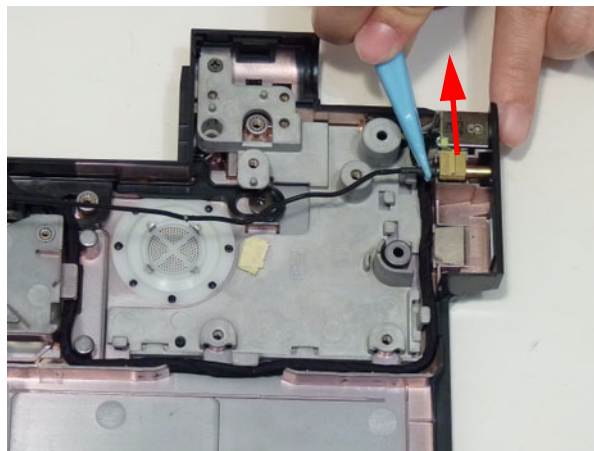

Removing the DC-In Cable Assembly

1. See "Removing the TV Tuner Cable Assembly" on page 93.
2. Remove the DC-In cable from the cable channel.

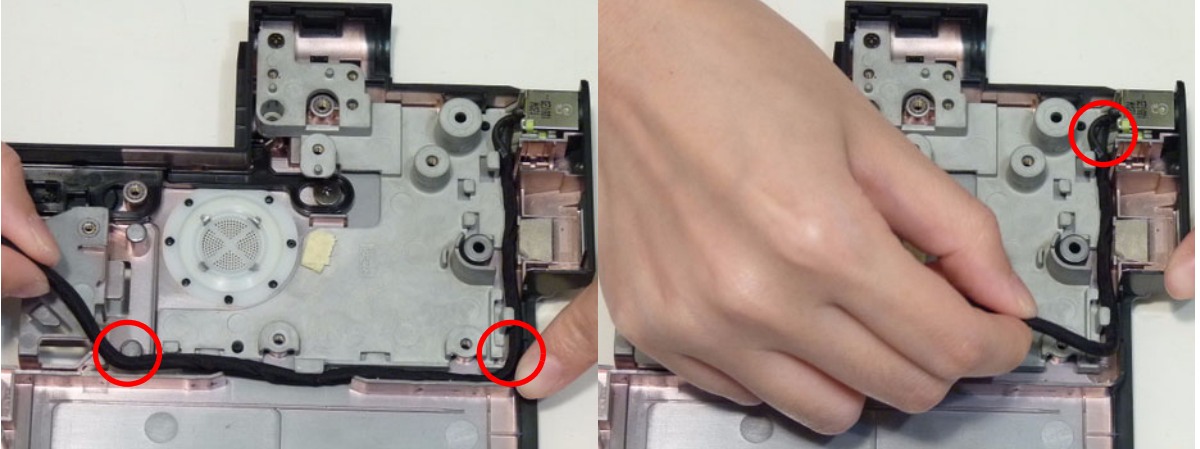

3. Lift the DC-In cable assembly out of the chassis.

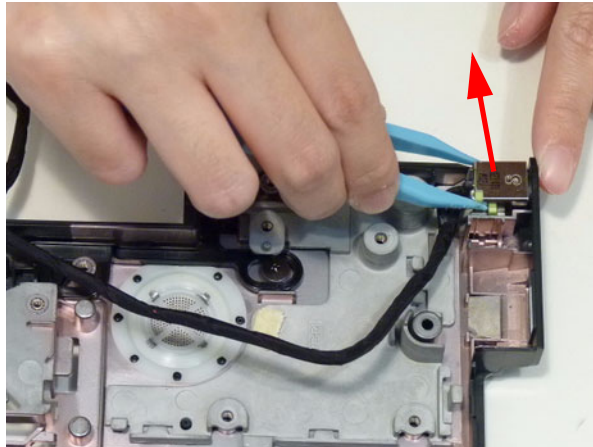

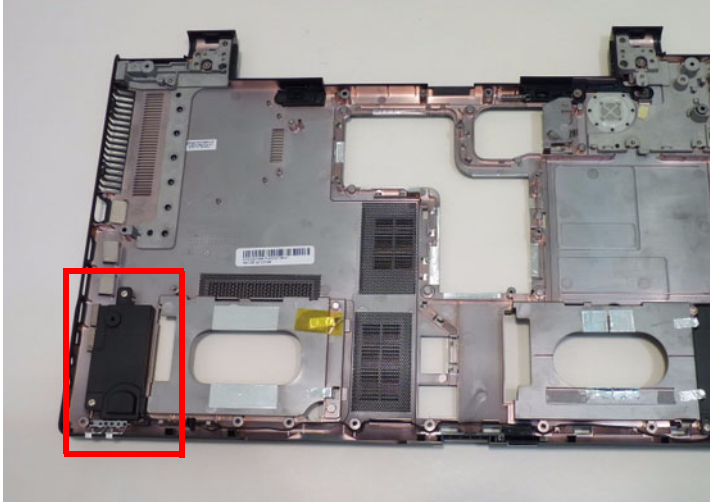

Removing the Front Speakers

1. See "Removing the Mainboard" on page 84.
2. Locate the front speaker on the lower cover

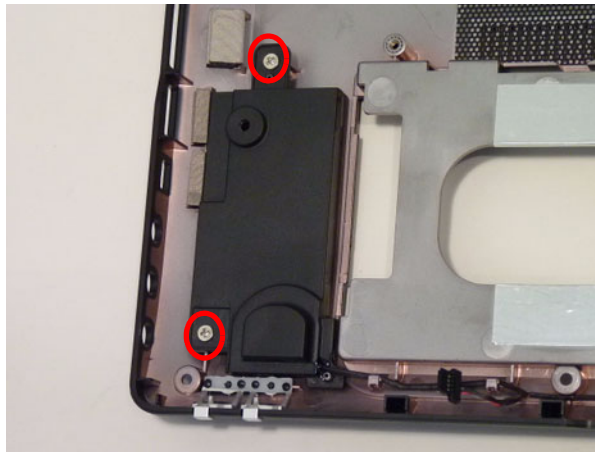

3. Remove two (2) screws from the front speaker.



Step	Screw	Quantity	Screw Type.
Front Speaker Disassembly	M2.5*4	2	

- Lift the speaker from the lower cover.

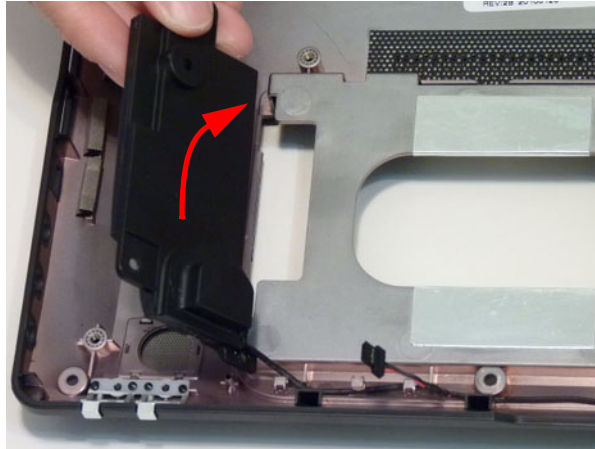

- Continue removing the cable from the cable channel.

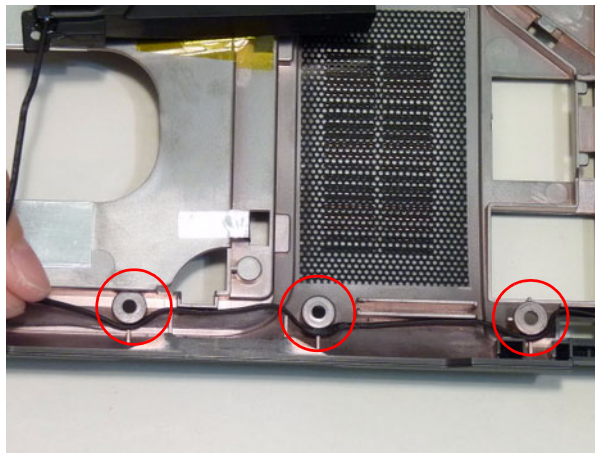

- Remove the two (2) screw from the remaining front speaker.

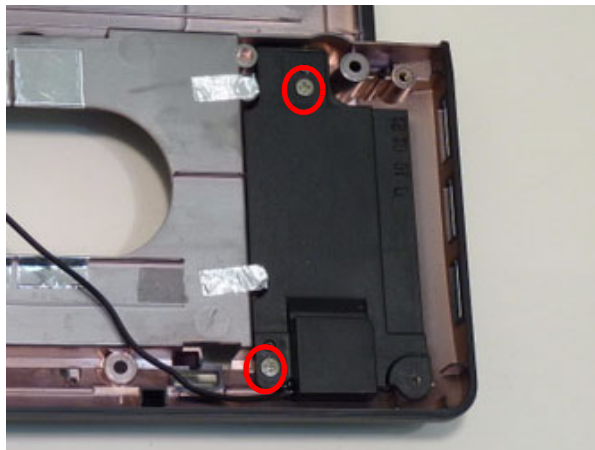

Step	Screw	Quantity	Screw Type.
Front Speaker Disassembly	M2.5*4	2	

-
7. Lift the front speaker assembly clear of the lower cover.

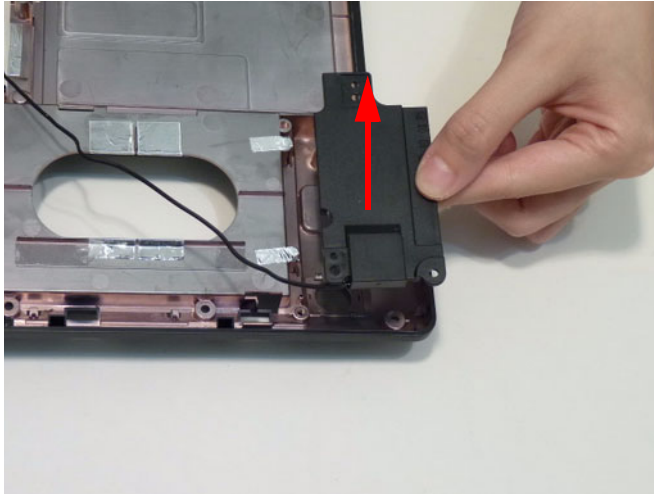

LCD Module Disassembly Process

IMPORTANT: Cable paths and positioning may not represent the actual model. During the removal and replacement of components, ensure all available cable channels and clips are used and that the cables are replaced in the same position.

NOTE: The product previews seen in the disassembly procedures may not represent the final product color or configuration.

LCD Module Disassembly Flowchart

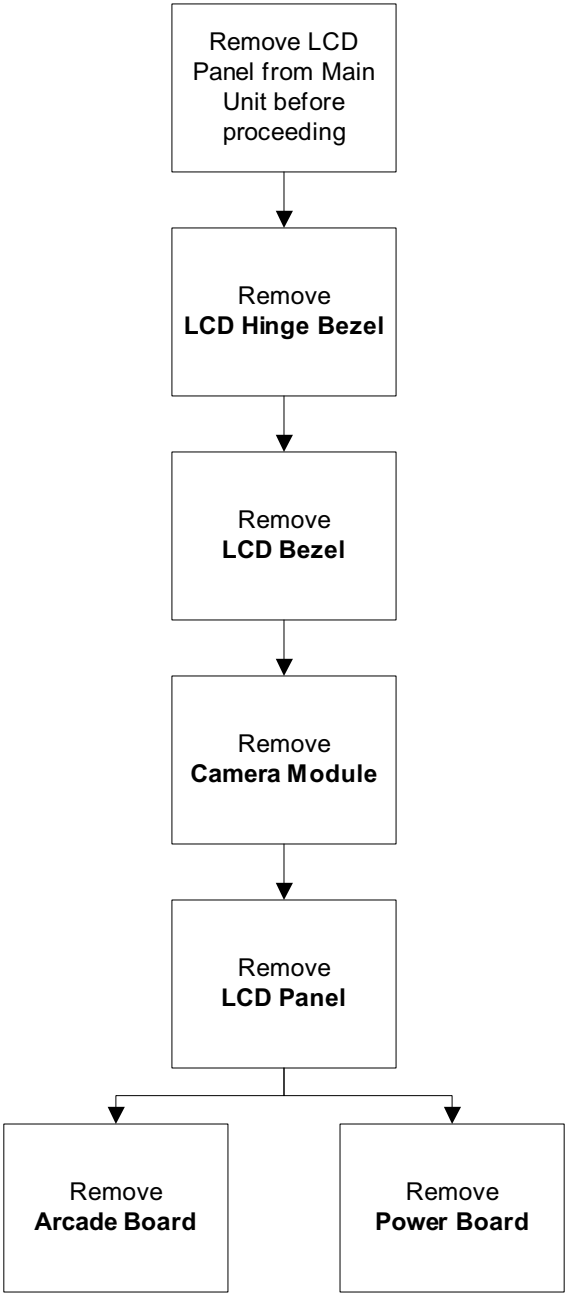

LCD Module Screw List

Step	Screw	Quantity	Part No.
LCD Glass Panel Disassembly	M2.5*4	6	86.PWL02.010
LCD Panel Disassembly	M2.5*4	8	86.PWL02.010
	M2.5*4	1	86.PWL02.010
LCD Bracket Disassembly	M2*3	6	86.PWL02.002
Arcade Board Disassembly	M2*3	2	86.PWL02.002
Power Board Disassembly	M2*3	2	86.PWL02.002

Removing the LCD Hinge Bezel

1. See “Main Unit Disassembly Process” on page 65.
2. Pull the left and right hinge cable bundles clear of the hinge bezel as shown.

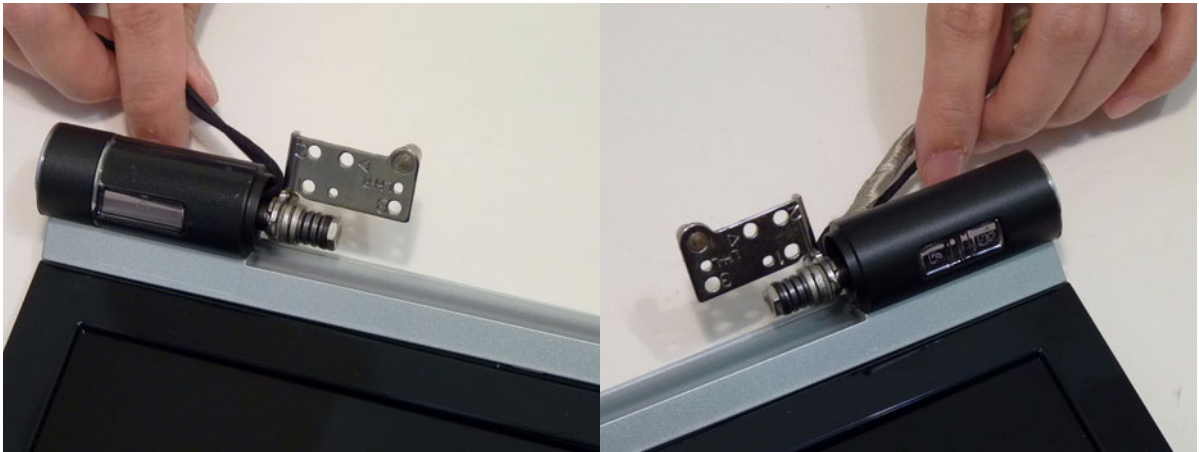

3. Insert a plastic pry to separate the hinge bezel from the LCD module. Work from side to side until all latches are unlocked.

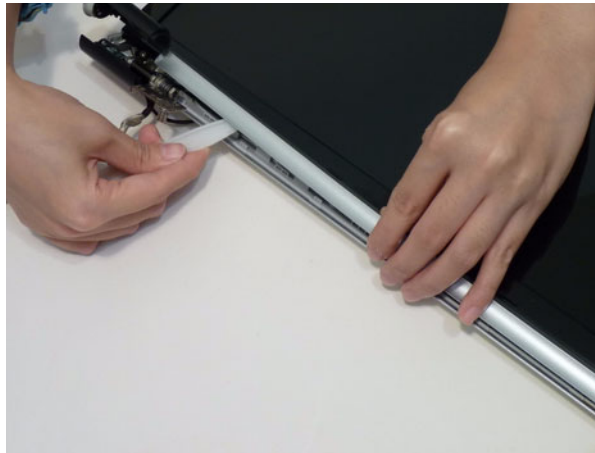

4. Lift the hinge bezel clear of the LCD module.

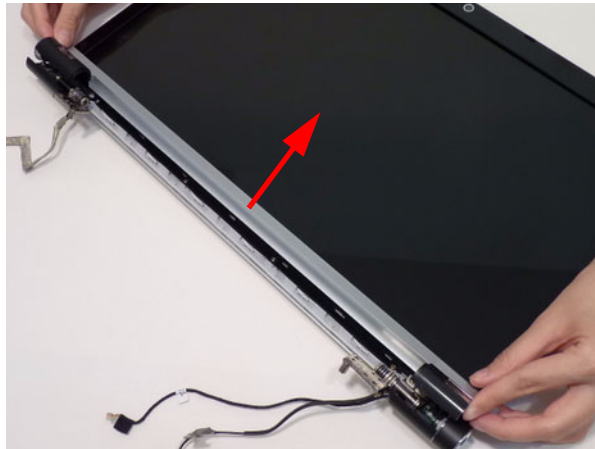

Removing the LCD Bezel

1. See "Removing the LCD Hinge Bezel" on page 99.
2. Remove six (6) screws from the glass panel.



Step	Screw	Quantity	Screw Type
LCD Glass Panel Disassembly	M2.5*4	6	

3. Pry the bezel away starting at the bottom center. Then work around the front corners until the bezel is separated from the module.

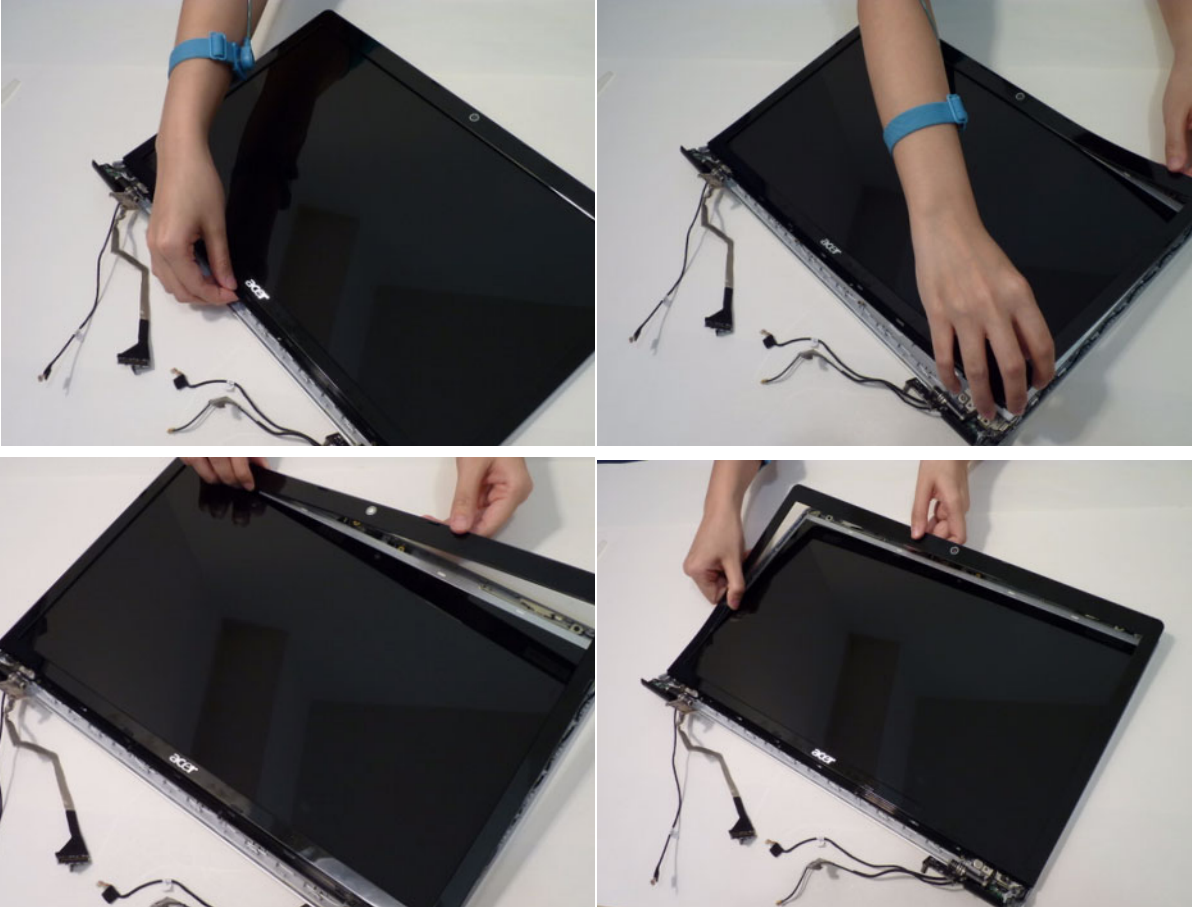

4. Remove the bezel from the LCD module.

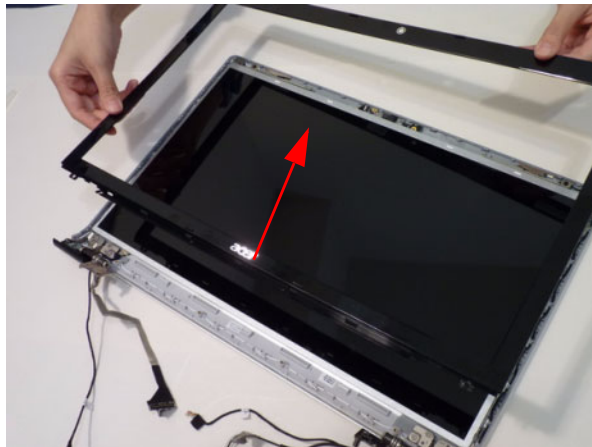

Removing the Camera Board

1. See "Removing the LCD Bezel" on page 101.
2. Disconnect the camera cable.

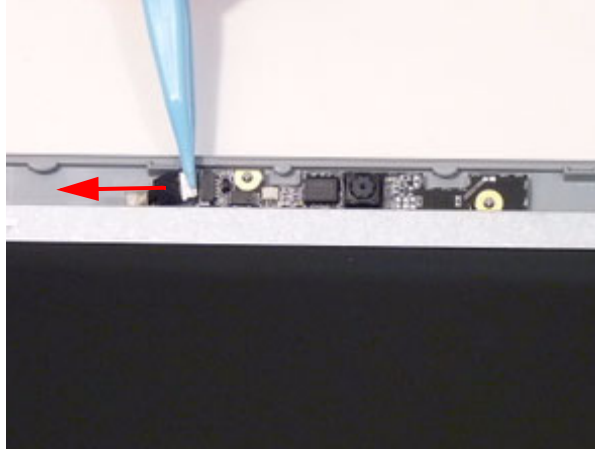

3. Pry the camera board away from the module.

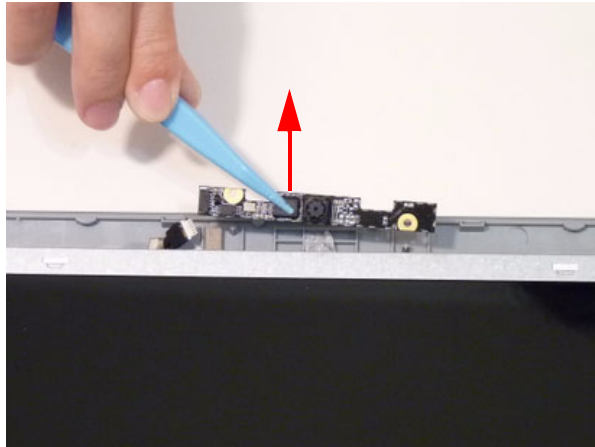

Removing the LCD Panel

1. See "Removing the LCD Bezel" on page 101.
2. See "Removing the Camera Board" on page 103.
3. Remove the eight (8) screws on the LCD panel.



Step	Screw	Quantity	Screw Type
LCD Panel Disassembly	M2.5*4	8	

4. Remove the one (1) screw in the left hinge.

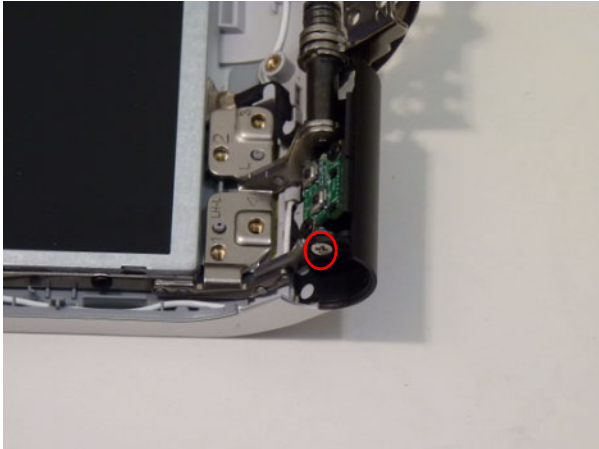

Step	Screw	Quantity	Screw Type
LCD Panel Disassembly	M2.5*4	1	

5. Lift the LCD panel out of the module.

CAUTION: To avoid damage, make sure all cables near the hinges are free and clear to move.



6. Remove six (6) screws from the LCD brackets (3 on each side).

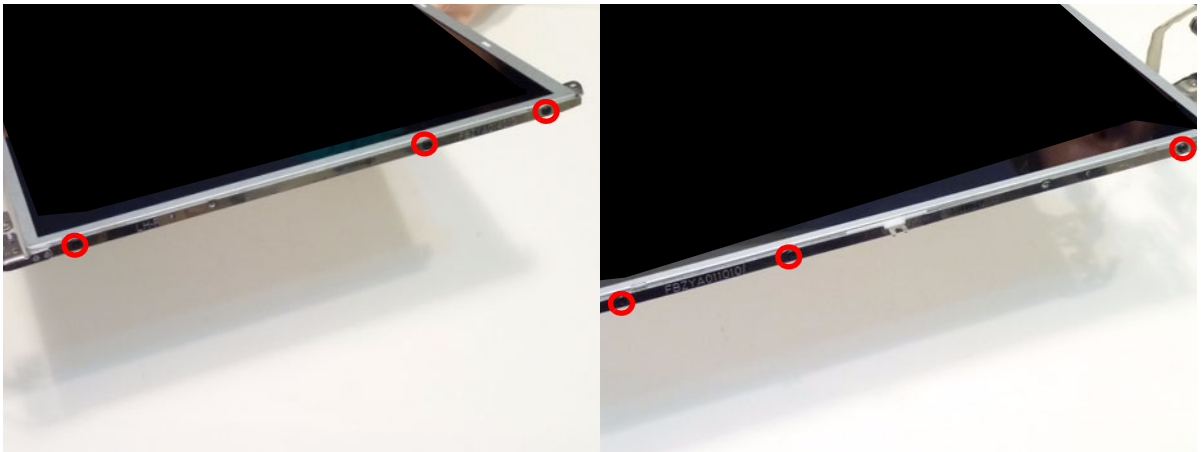

Step	Screw	Quantity	Screw Type
LCD Bracket Disassembly	M2*3	6	

7. Separate the brackets from the panel as shown.

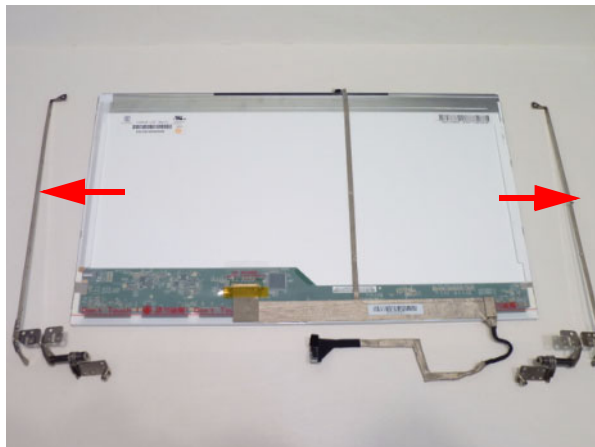

-
8. Remove the adhesive tape securing the LVDS cable to the LCD panel.

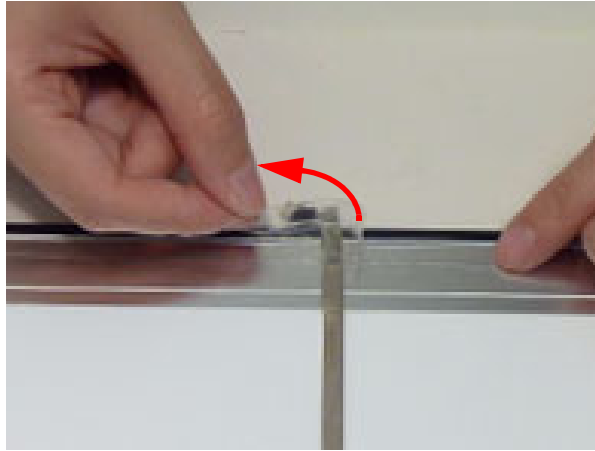

9. Peel the LVDS cable off the panel.

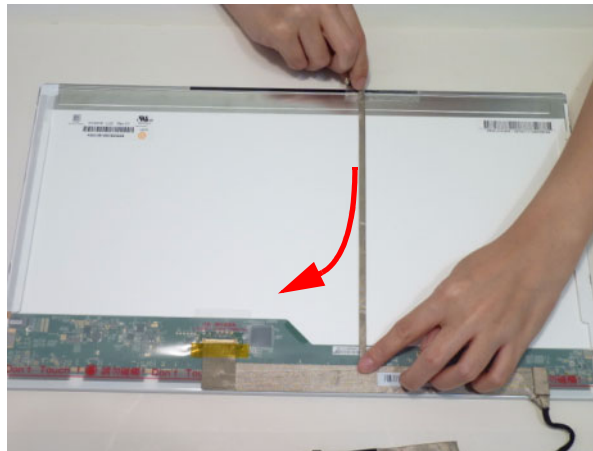

10. Continue peeling the cable off the LCD panel.

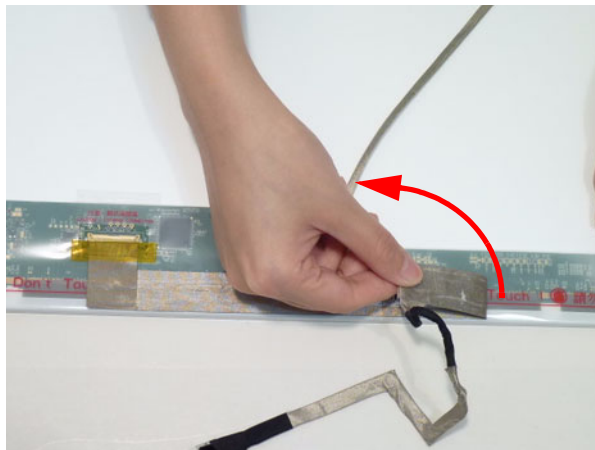

-
11. Peel back the mylar and disconnect the LVDS cable from the panel.

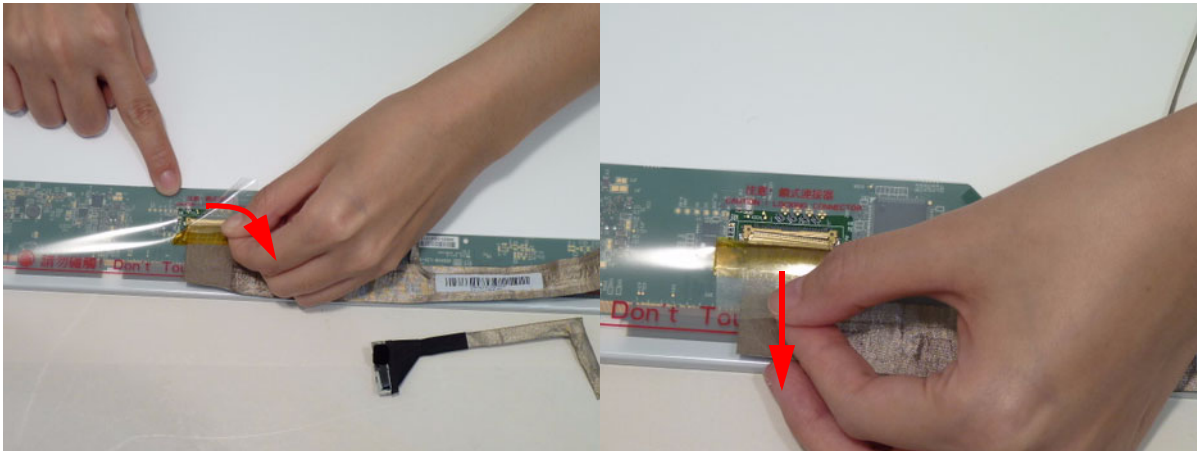

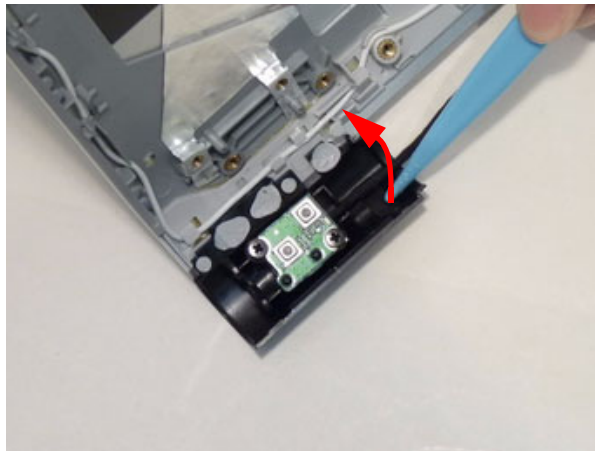

Removing the Arcade Board

1. See “Removing the LCD Panel” on page 104.
2. Peel back the adhesive tape securing the arcade board cable to the left hinge.

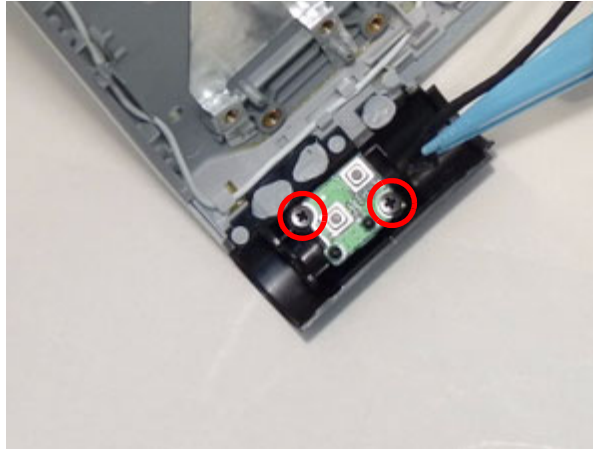

3. Remove the two (2) securing screws from the arcade board.



Step	Screw	Quantity	Screw Type
Arcade Board Disassembly	M2*3	2	

4. Lift the arcade board away.

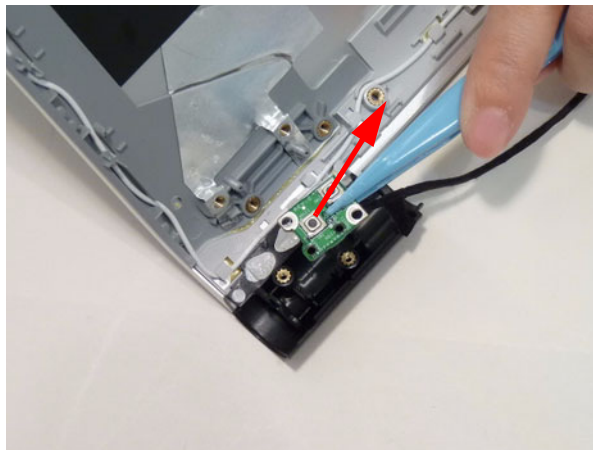

5. Disconnect the arcade board cable.

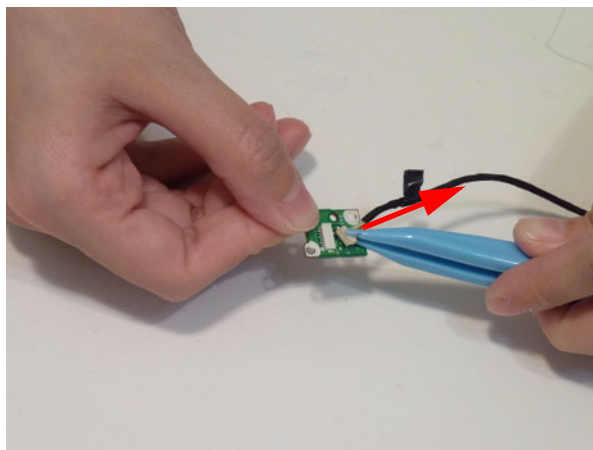



Removing the Power Board

1. See "Removing the LCD Panel" on page 104.
2. Peel back the adhesive tape securing the power board cable to the right hinge.

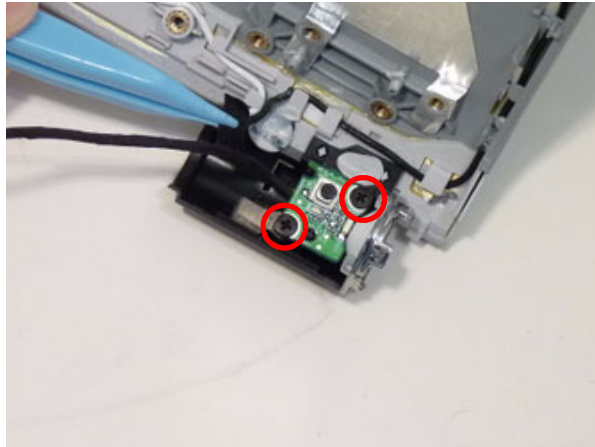

3. Remove two (2) screws from the power board.



Step	Screw	Quantity	Screw Type
Power Board Disassembly	M2*3	2	

-
4. Lift the power board clear of the right hinge.

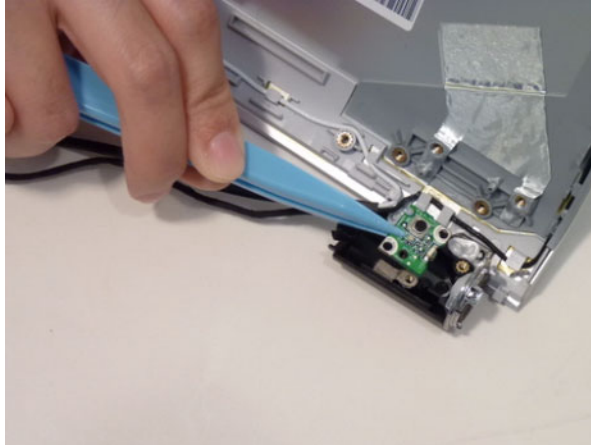

5. Disconnect the power board cable from the connector.

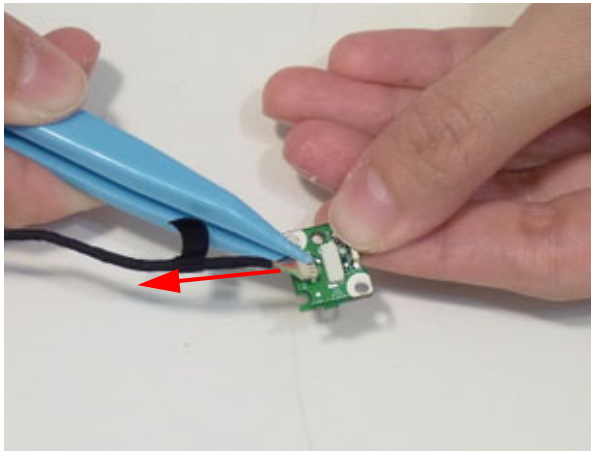

LCD Reassembly Procedure

NOTE: During manufacture a cyanoacrylate glue is used provided by Holdtite Adhesives LTD. This is not a specified requirement. The reassembler is free to select an alternative appropriate adhesive.

Replacing the Power Board

1. Connect the power board cable to the connector.

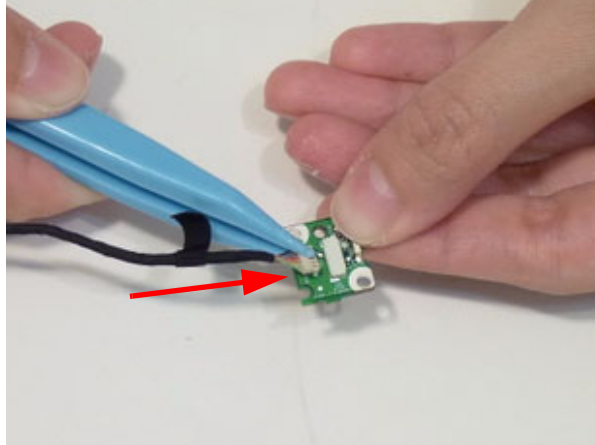

2. Place the power board in the right hinge.

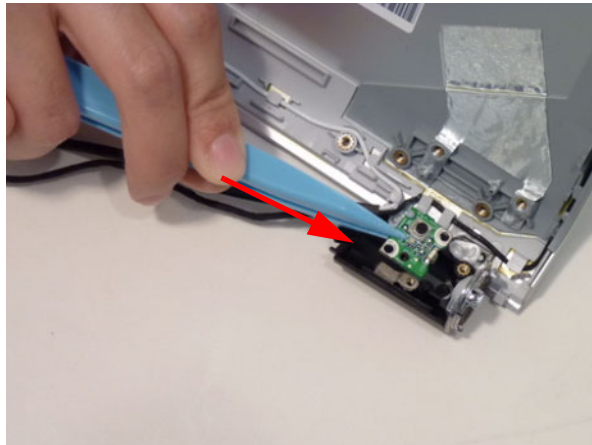

3. Replace the two (2) screws to secure the power board.

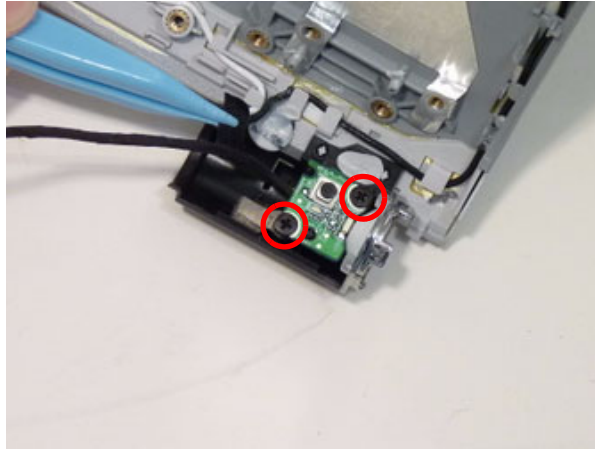

Step	Screw	Quantity	Screw Type
Power Board Assembly	M2*3	2	

4. Secure the power board cable to the inside of the right hinge using a strip of adhesive tape.

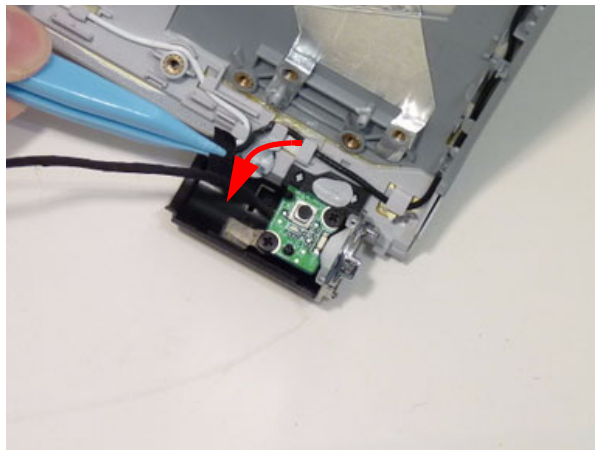

Replacing the Arcade Board

1. Connect the cable to the arcade board.

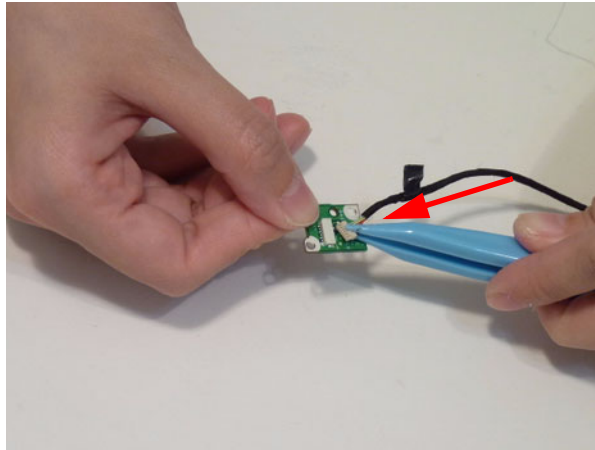

2. Place the arcade board in the left hinge.

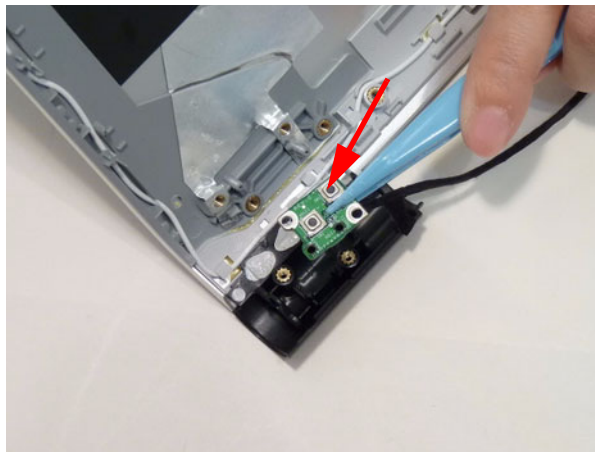

3. Replace the two (2) screws to secure the arcade board.

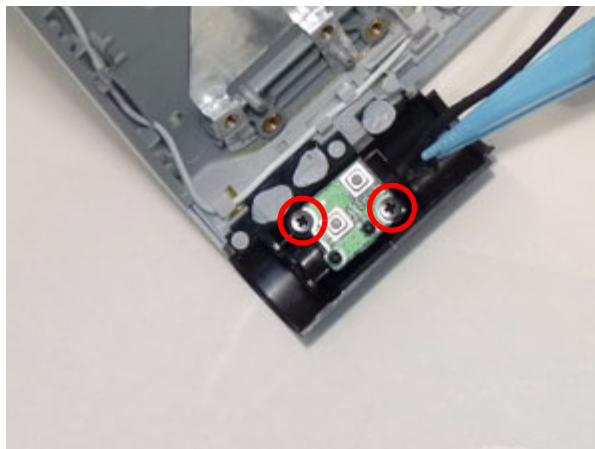

Step	Screw	Quantity	Screw Type
Arcade Board Assembly	M2*3	2	

4. Secure the arcade board cable to the inside of the left hinge using a strip of adhesive tape.

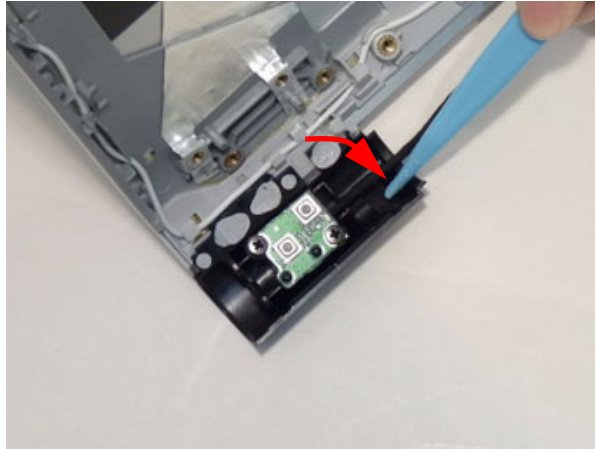

Replacing the LCD Panel

1. Connect the LVDS cable to the panel and adhere the mylar to secure the connector.

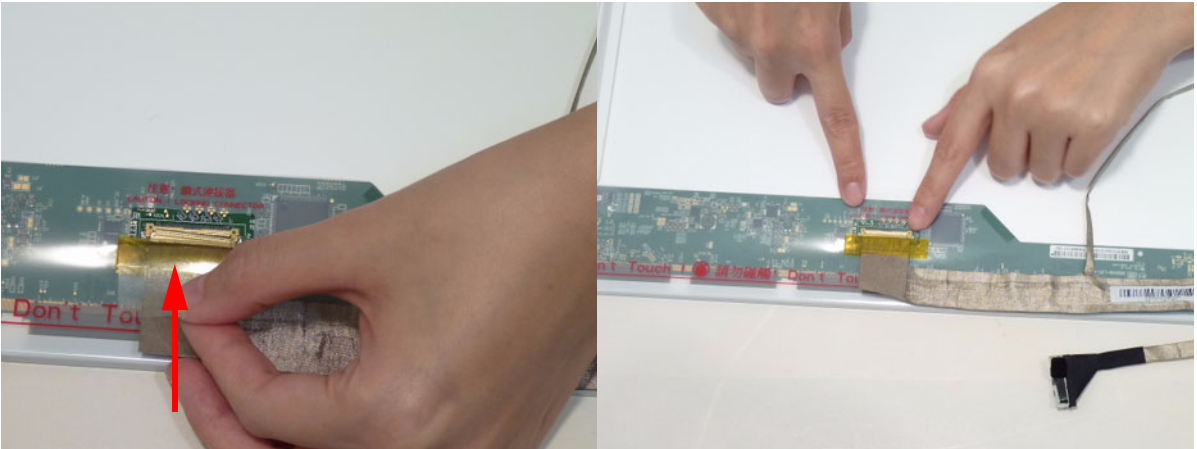

2. Press down on the LVDS cable to adhere the adhesive to the panel as shown.

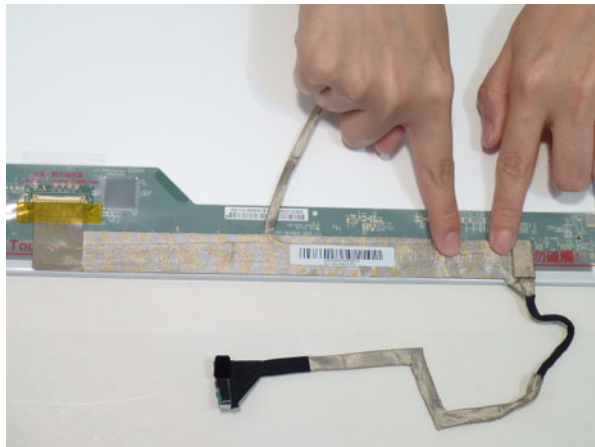

3. Continue attaching the cable to the panel. Make sure the cable adhesive is secured in the places indicated between the red callouts.

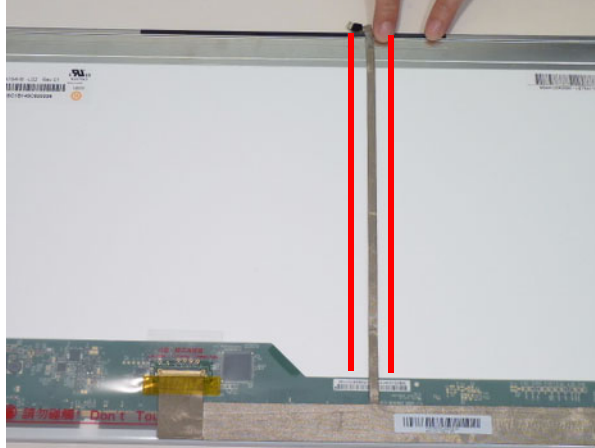

4. Replace the adhesive tape to secure the LVDS cable to the LCD panel.

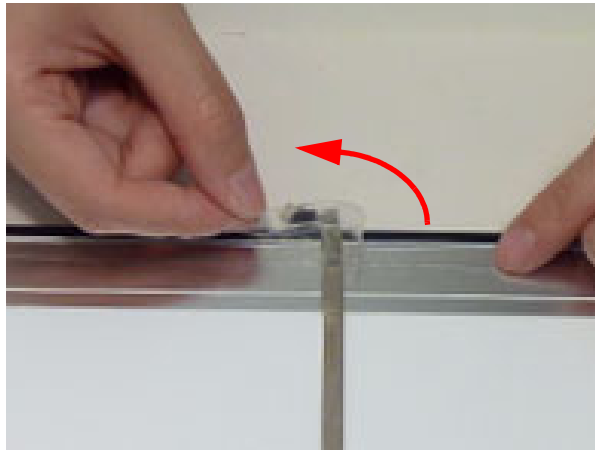

5. Attach the brackets to the panel as shown.

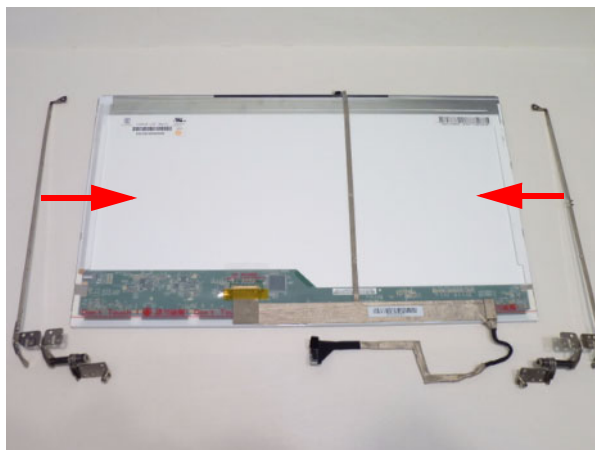

6. Replace six (6) screws on the LCD brackets (3 on each side)

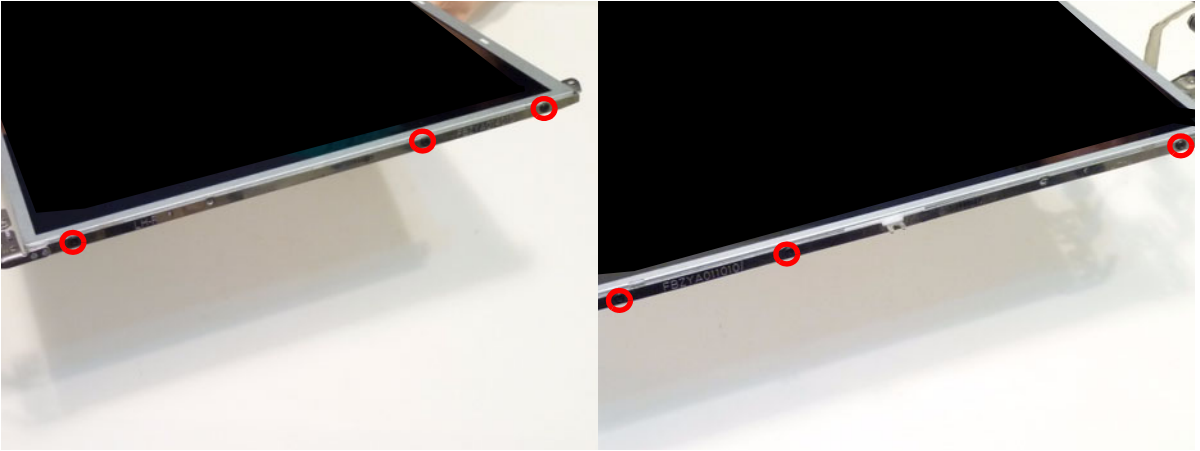

Step	Screw	Quantity	Screw Type
LCD Bracket Assembly	M2*3	6	

7. Carefully place the LCD panel in the module by first lining up the brackets in the hinges before lowering into place.

CAUTION: To avoid damage, make sure no cables are caught between the brackets and hinge during replacement.



8. Replace the one (1) screw to secure the left hinge.

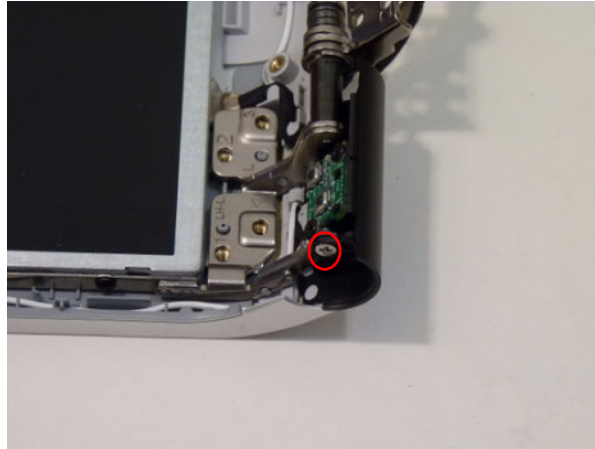

Step	Screw	Quantity	Screw Type
LCD Panel Assembly	M2.5*4	1	

9. Replace the eight (8) screws to secure the LCD panel.



Step	Screw	Quantity	Screw Type
LCD Panel Assembly	M2.5*4	8	

Replacing the Camera Board

1. Place the camera board on the LCD cover.

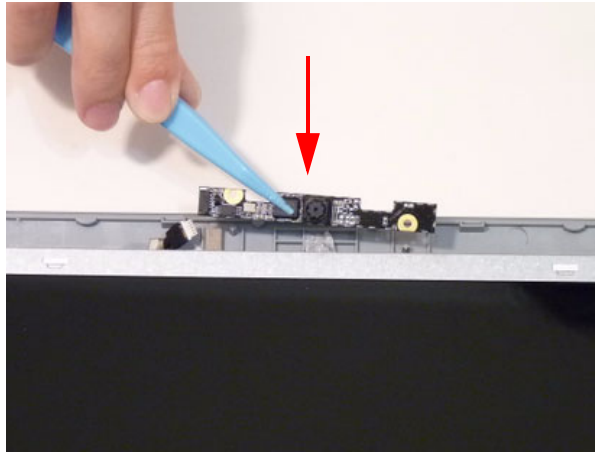

2. Connect the camera board cable.

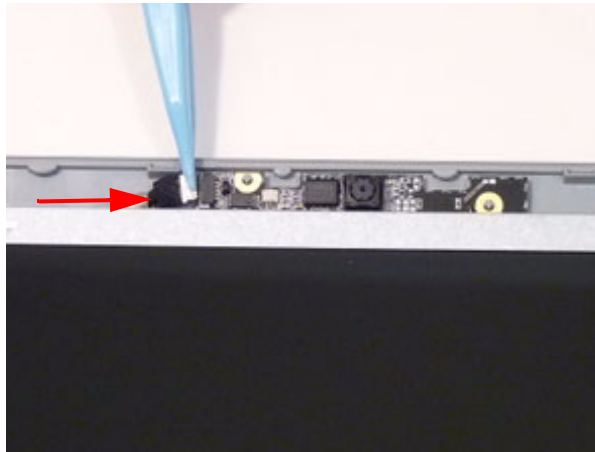

Replacing the LCD Bezel

1. Place the bezel on top of the LCD module.

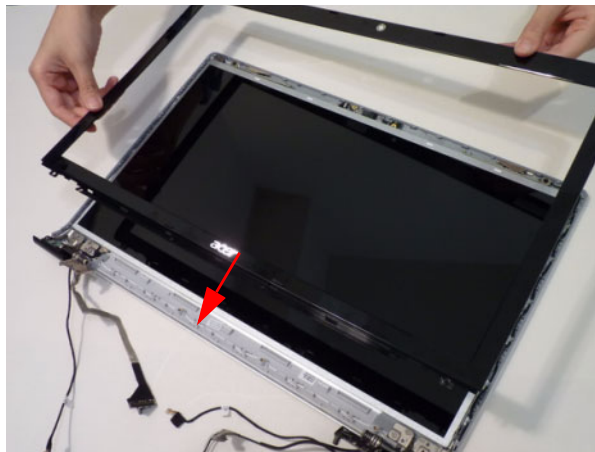

-
2. Press the bezel onto the module. Work from the top center to the bottom center as shown, until all latches have been locked and the bezel sits flush on the module.

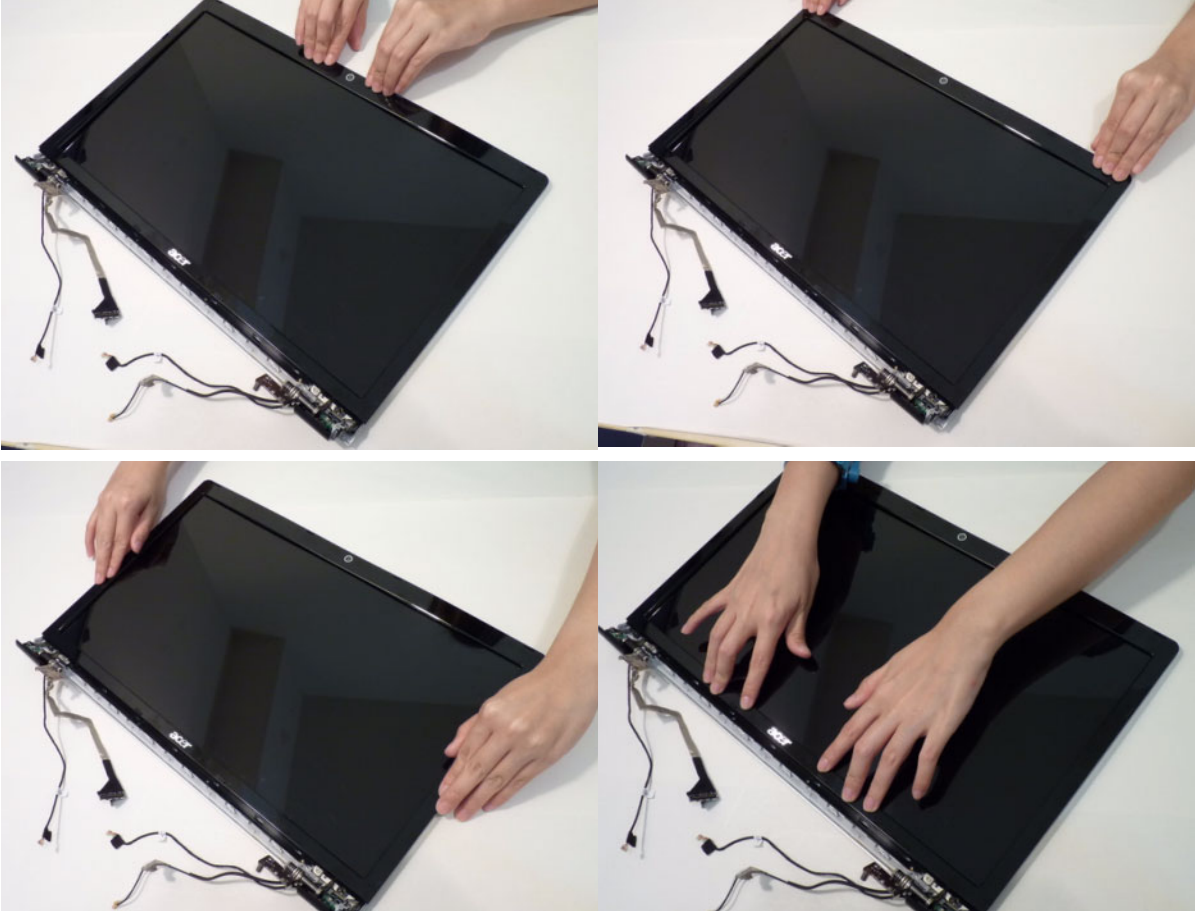

3. Replace six (6) screws on the glass panel.



Step	Screw	Quantity	Screw Type
LCD Glass Panel Assembly	M2.5*4	6	

Replacing the LCD Hinge Bezel

1. Place the hinge bezel on top of the LCD module.

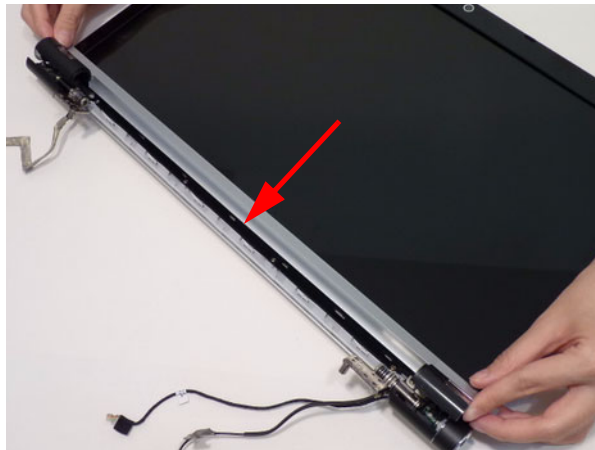

-
2. Press down on the hinge bezel to engage the locking clips.

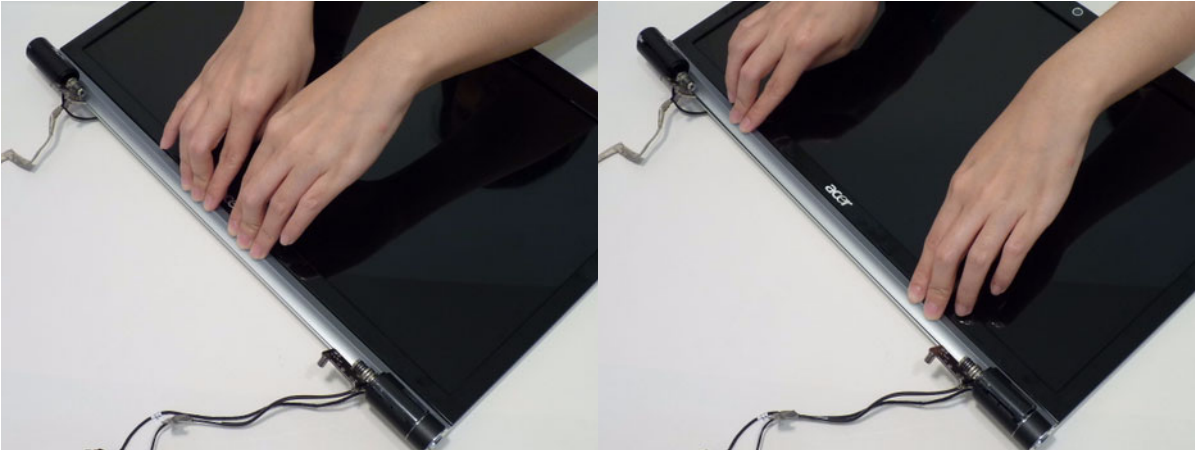

3. Press the right hinge cap into place until it sits flush with the LCD cover.



Main Unit Reassembly Process

Replacing the Front Speakers

1. Place the first speaker in the lower right hand side of the lower cover.

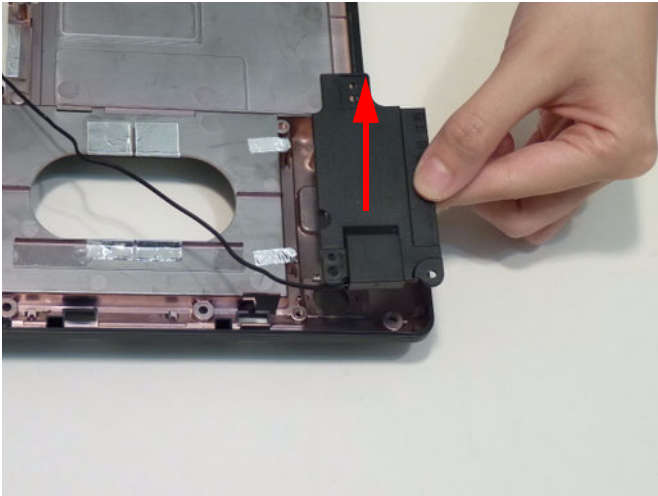

2. Replace the one (1) screw to secure the front speaker.



Step	Screw	Quantity	Screw Type.
Front Speaker Assembly	M2.5*4	2	

3. Run the cable along the cable channel as shown.

IMPORTANT: Make sure the cable is secured in all cable clips and around all retention guides for proper installation.

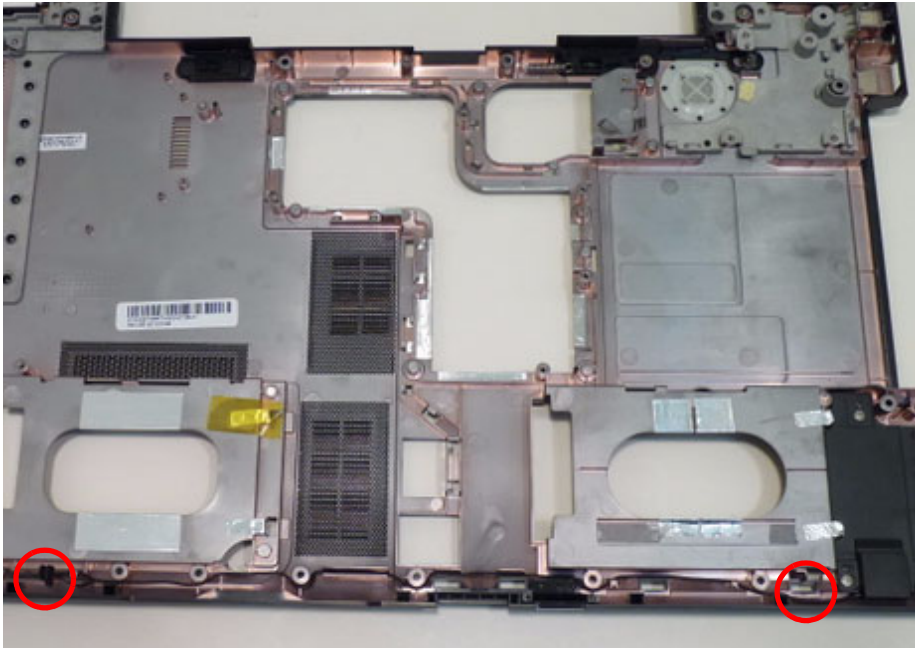

4. Line up the remaining speaker with the pin guide and place securely in the lower cover.

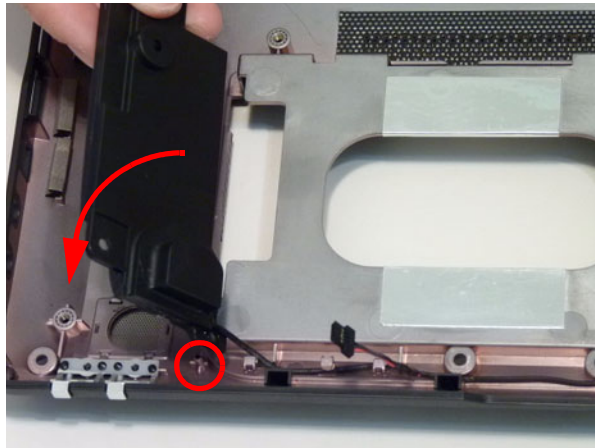

5. Replace the two (2) screws to secure the front speaker.

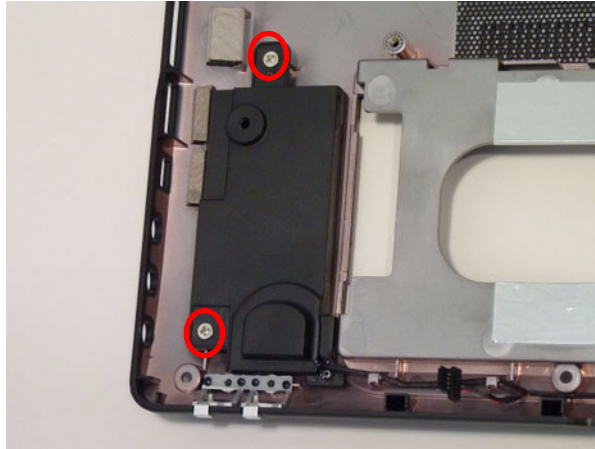

Step	Screw	Quantity	Screw Type.
Front Speaker Assembly	M2.5*4	2	

6. The completed front speaker assembly should look like the following image:

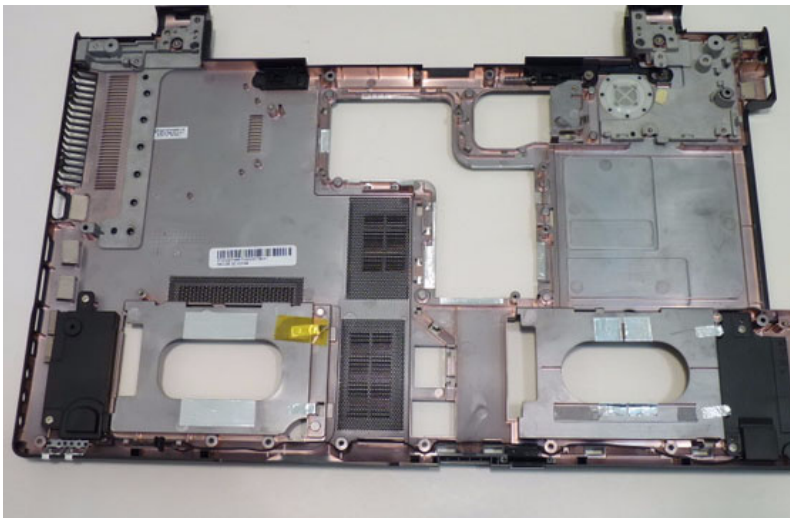

Replacing the DC-In Cable Assembly

1. Place the DC-In port in the chassis.

IMPORTANT: Make sure the port is lined up with the lower cover to ensure proper functioning.

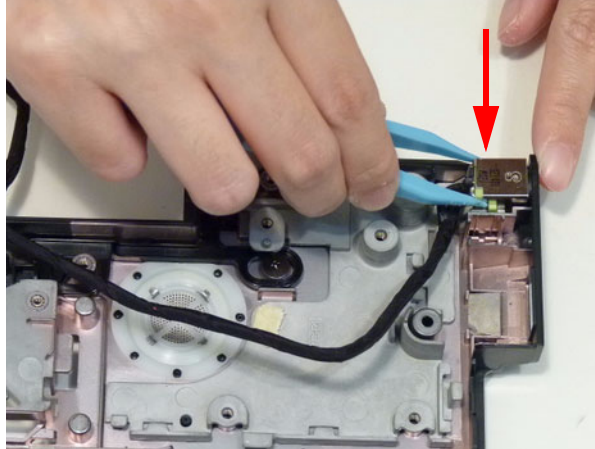

2. Run the DC-In cable along the cable channel as shown.

IMPORTANT: Make sure the cable is secured in all cable clips and around all retention guides for proper installation.

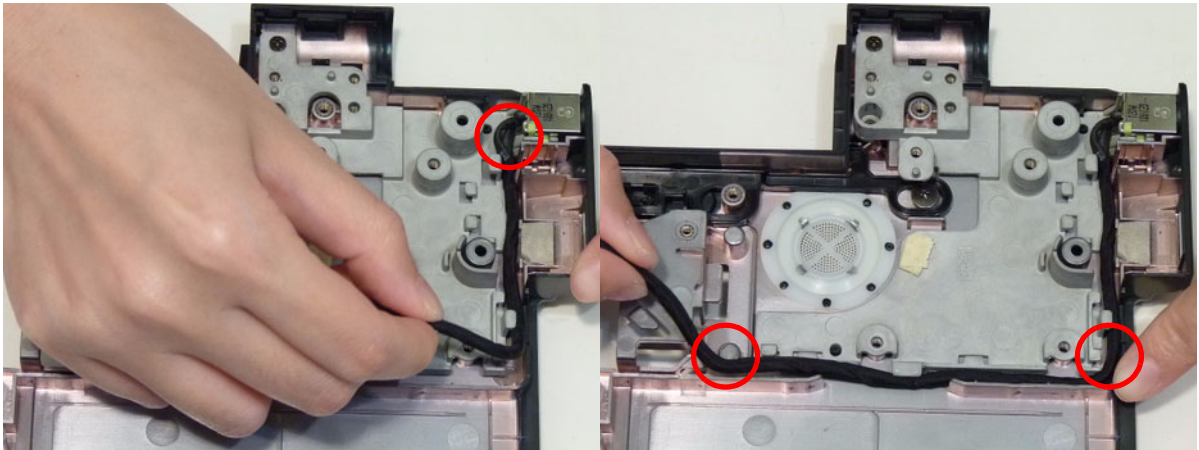

Replacing the TV Tuner Cable Assembly

1. Place the TV Tuner port in the chassis.

IMPORTANT: Make sure the port is lined up with the lower cover to ensure proper functioning.

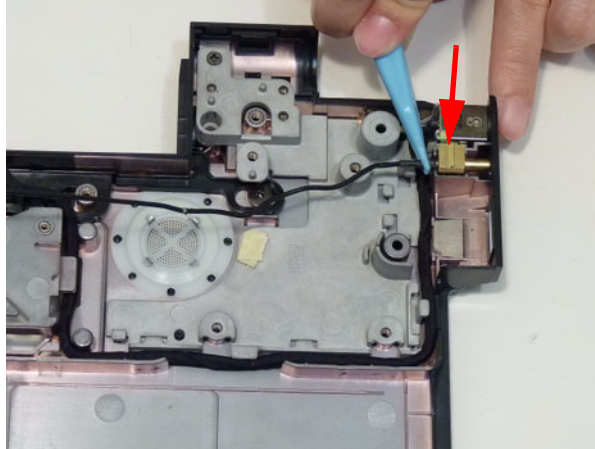

2. Run the TV Tuner cable along the cable channel as shown.

IMPORTANT: Make sure the cable is secured in all cable clips and around all retention guides for proper installation.

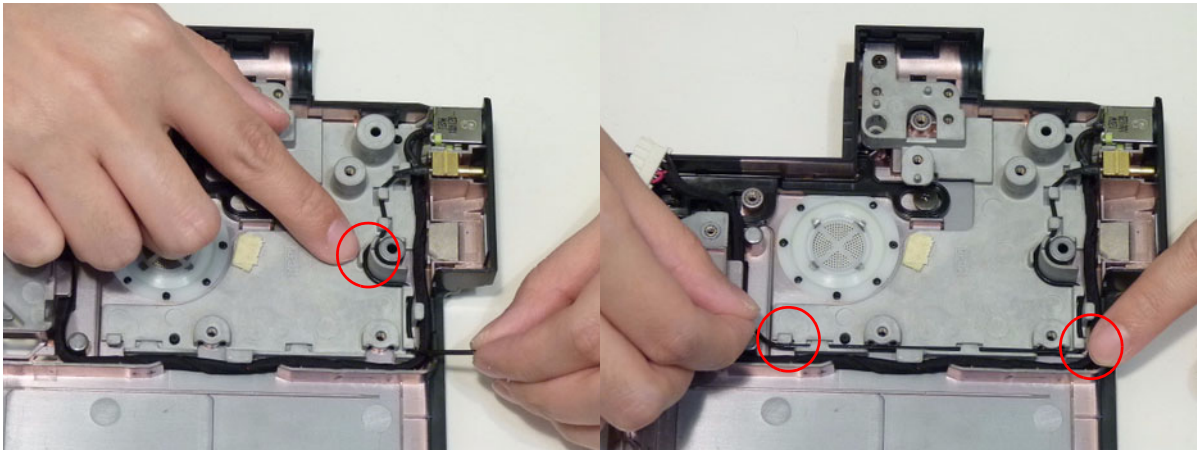

3. Pass the TV Tuner cable through the indicated location in the chassis.

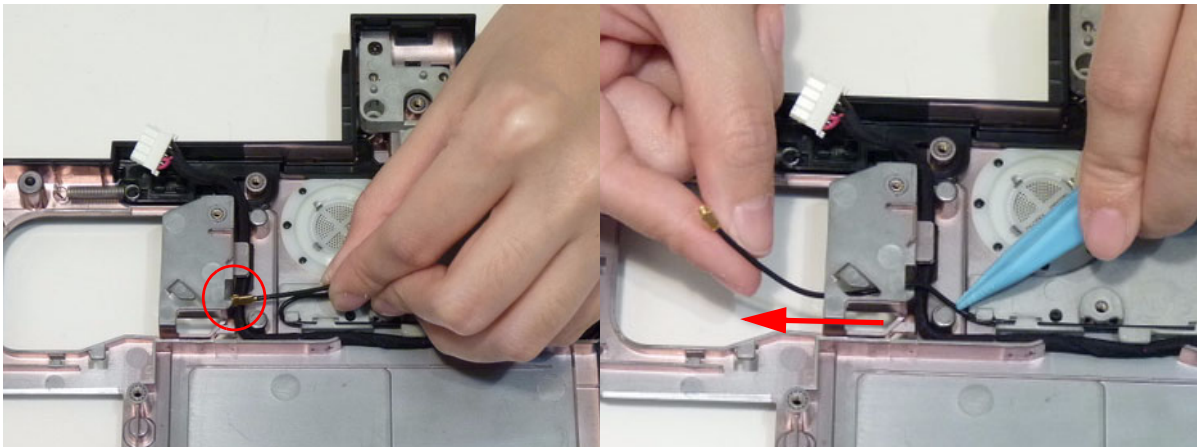

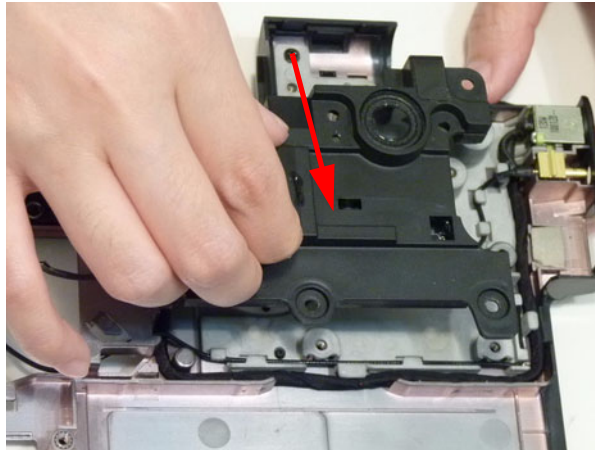

Replacing the Subwoofer and Back Speaker

1. Place the subwoofer in the top right hand corner of the lower cover.

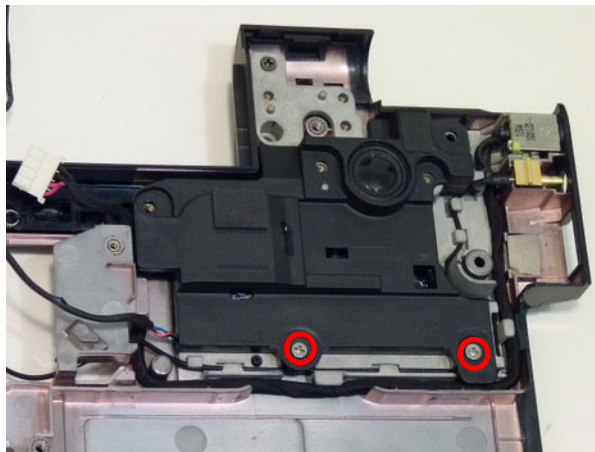

2. Replace two (2) screws in the subwoofer.



Step	Screw	Quantity	Screw Type.
Subwoofer Assembly	M2.5*4	2	

3. Run the cable in the cable channel as shown.

IMPORTANT: Make sure the cable is secured in all cable clips and around all retention guides for proper installation.

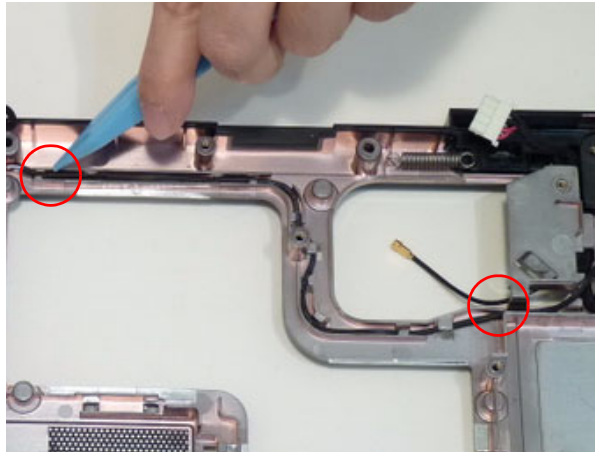

4. Line up the back speaker with the pin guide and place securely in the lower cover.

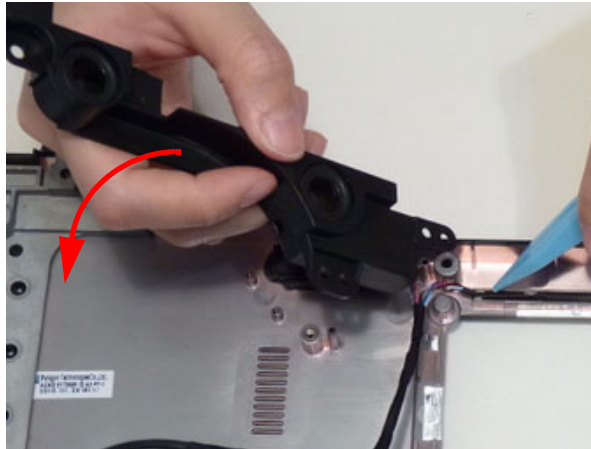

5. Replace the one (1) screw to secure the front speaker.

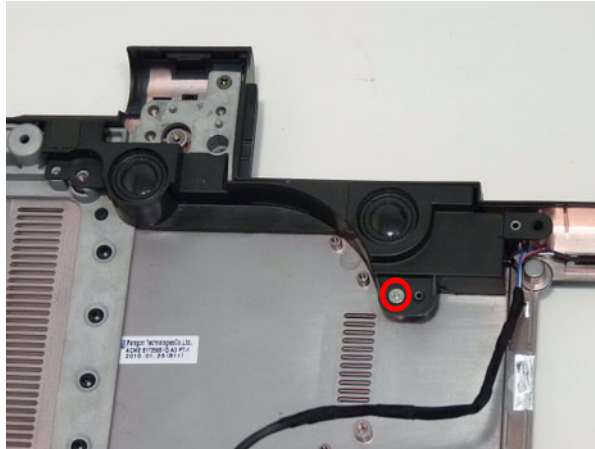

Step	Screw	Quantity	Screw Type.
Back Speaker Assembly	M2.5*4	1	

6. Complete the assembly by running the cable through the cable channel.

IMPORTANT: Make sure the cable is secured in all cable clips and around all retention guides for proper installation.

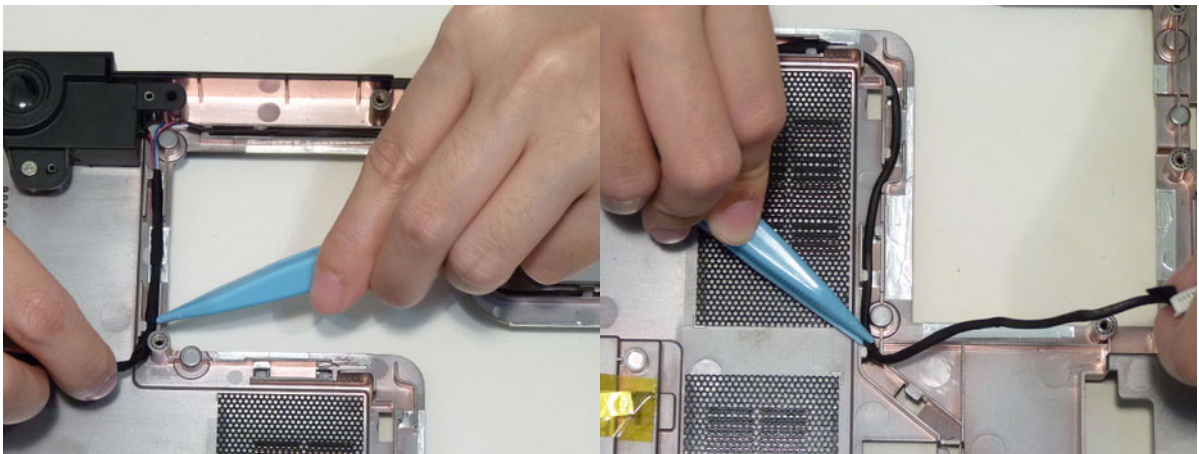
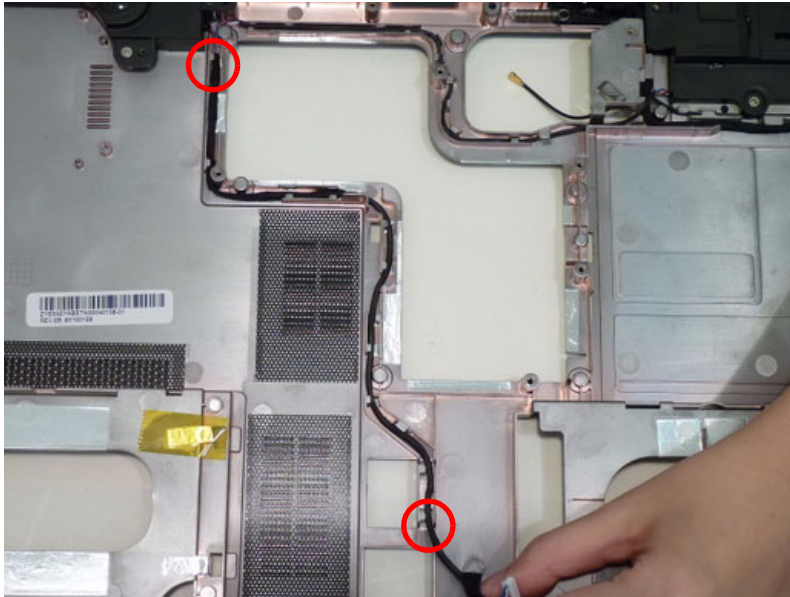

Replacing the PCH Heatsink.

1. Place the PCH Heatsink on the mainboard. Make sure to line up the module with the pin guides.

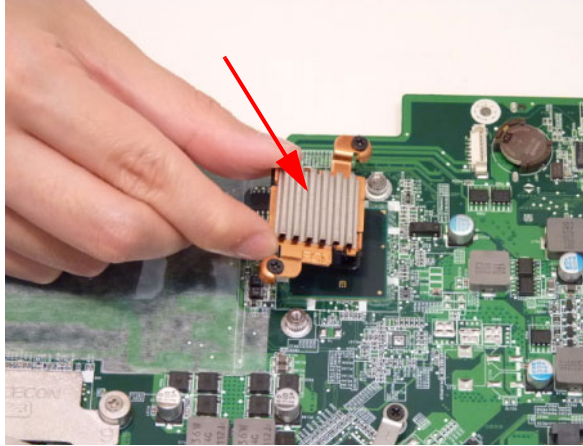

2. Tighten the two (2) captive screws.

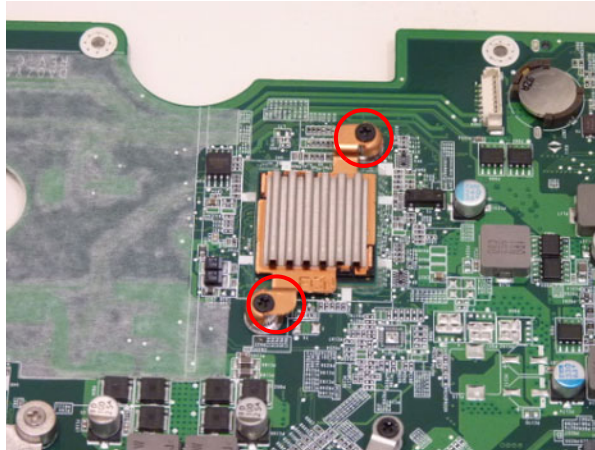

Replacing the CPU

IMPORTANT: The CPU has a Pin1 locator that must be positioned corresponding to the marker on the CPU socket.

1. Place the CPU into the CPU socket as shown, taking note of the Pin1 locator.

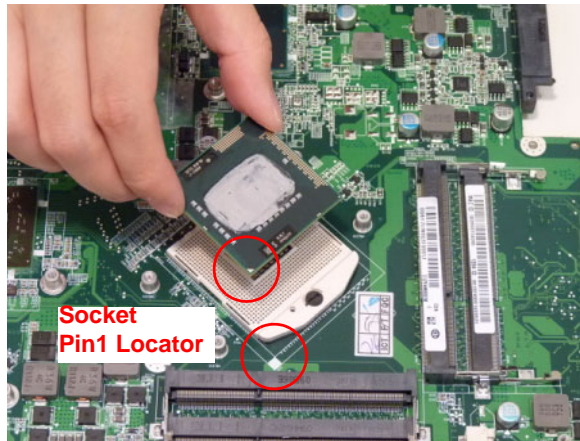

2. Using a flat-bladed screw driver, rotate the CPU locking screw 180° clockwise to secure the CPU in place.

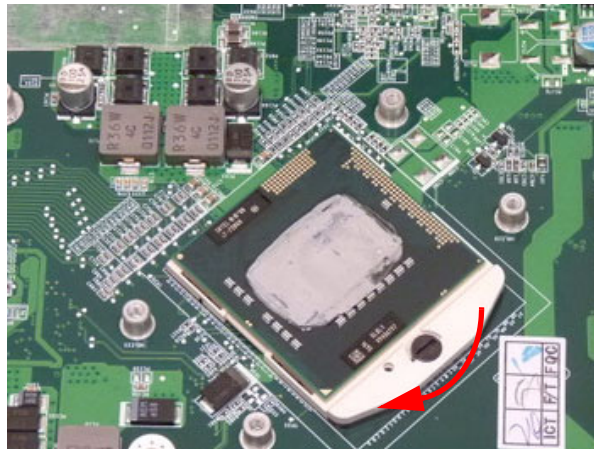

Replacing the Thermal Module

IMPORTANT: Apply a suitable thermal grease and ensure all heat pads are in place before replacing the thermal module.

The following thermal grease types are approved for use:

- Silmore GP50
- Honeywell
- Jet Motor 7762

The following thermal pads are approved for use:

- Eapus XR-PE
1. Remove all traces of thermal grease from the CPU using a lint-free cloth or cotton swab and Isopropyl Alcohol, Acetone (1), or other approved cleaning agent.
 2. Apply a small amount of thermal grease to the centre of the CPU—there is no need to spread the grease manually, the force used during the installation of the thermal module is sufficient.
 3. Align the screw holes on the thermal module and mainboard then replace the module. Keep the module as level as possible to spread the thermal grease evenly.

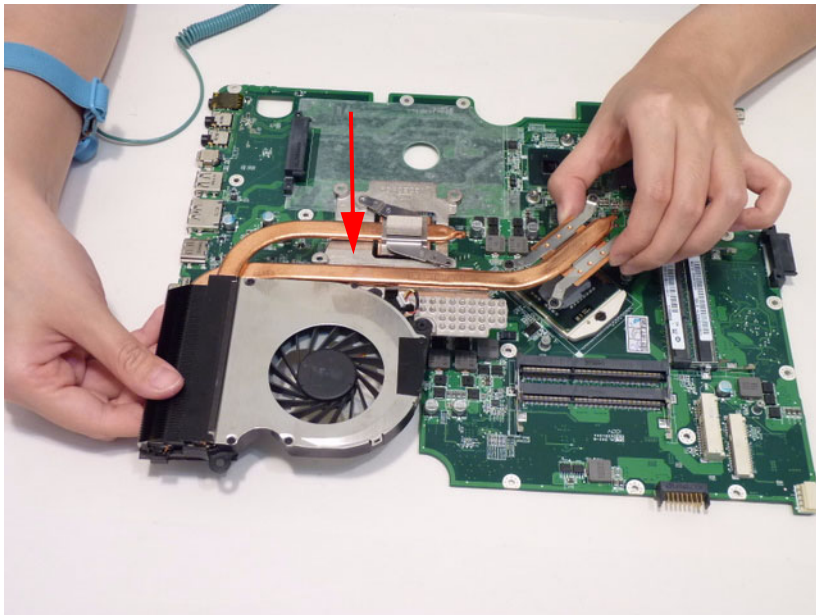

4. Replace the five (5) non-captive screws (blue callouts) in numerical order: 5, 6, 7, 8, 9. Tighten the four (4) captive screws (red callouts) in numerical order: 1, 2, 3, 4.

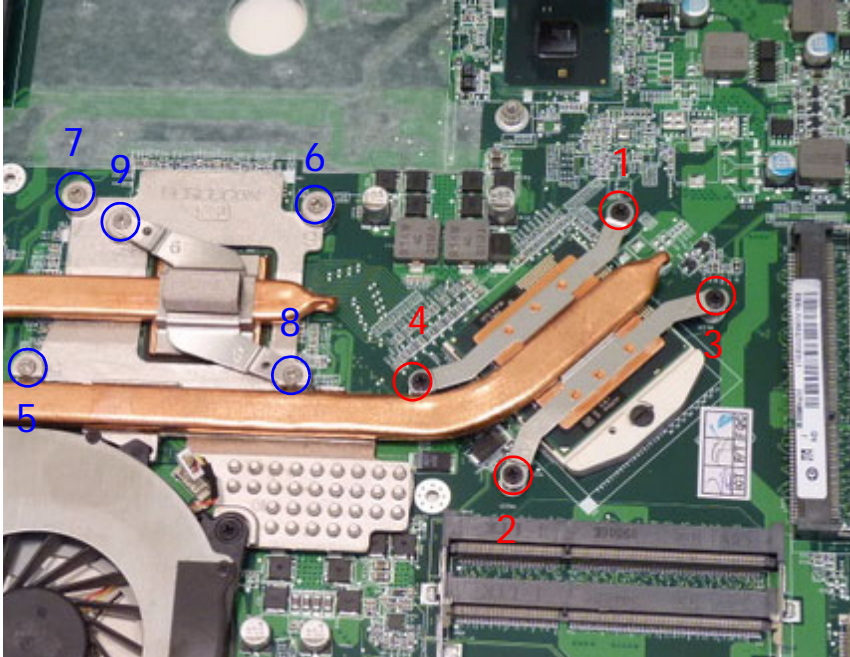

5. Connect the fan cable.

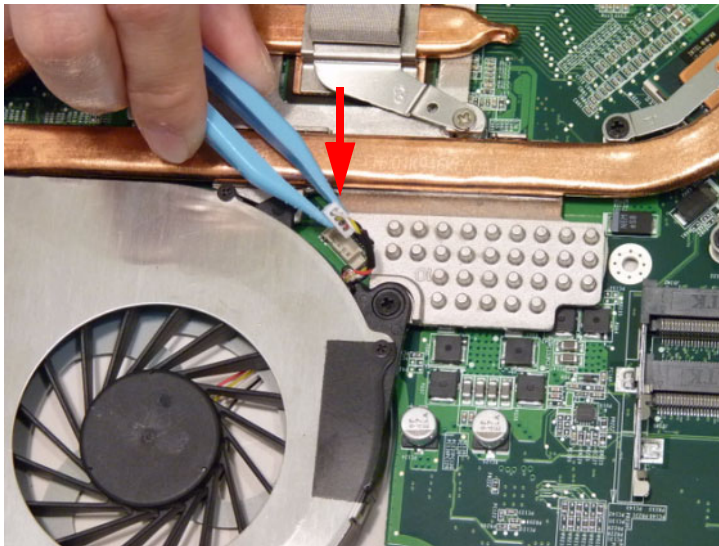

Replacing the RTC Battery

1. Place a new RTC battery with the positive (+) side up, into the battery slot on the mainboard as shown.

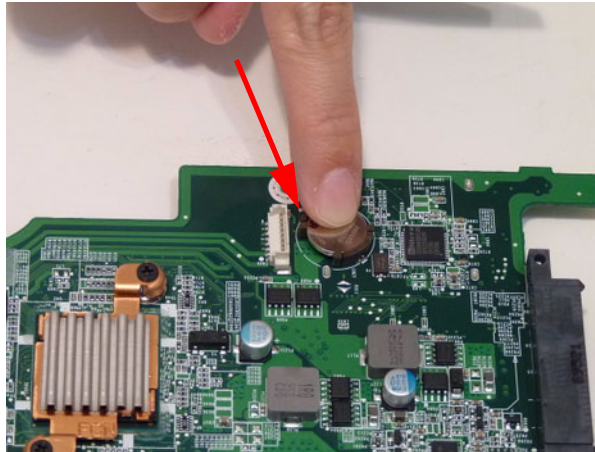

Replacing the Mainboard

1. Slide the mainboard external connector edge in first to the lower case, then lower into place.

IMPORTANT: Make sure all cables are clear of the mainboard to avoid damage.

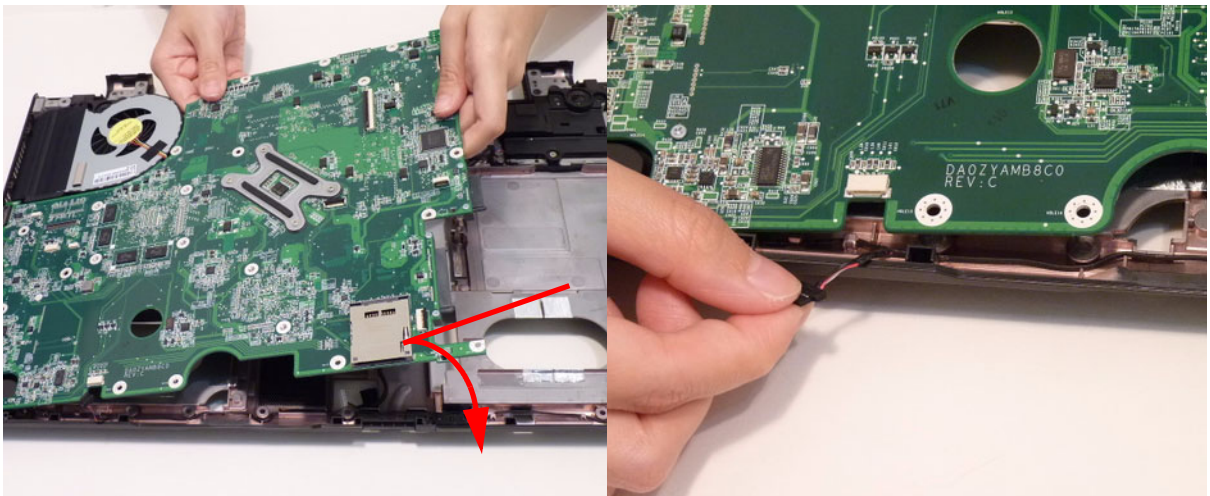

2. Replace the two (2) screws to secure the mainboard to the lower cover.

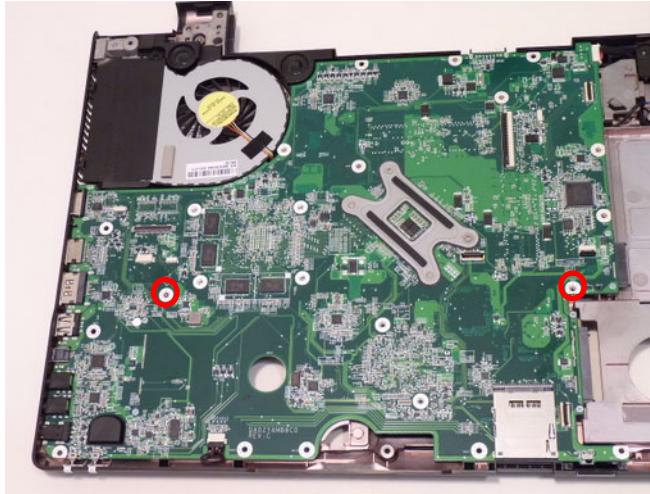

Step	Screw	Quantity	Screw Type.
Main Board Assembly	M2.5*6	2	

3. Turn the computer over and connect the DC-In cable.

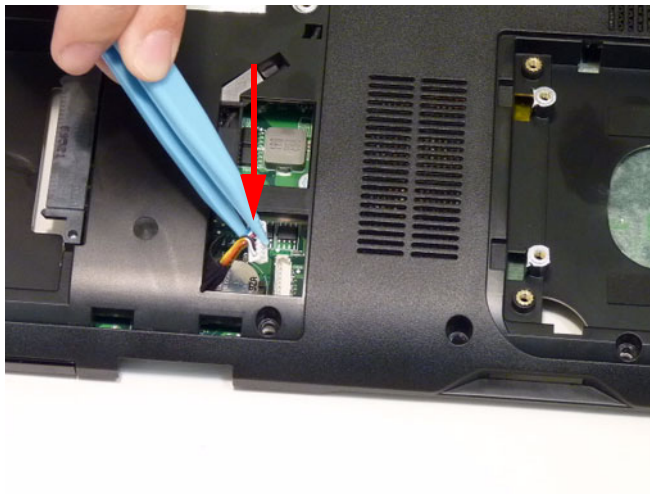

4. Connect the following cables (a, b) on the mainboard.

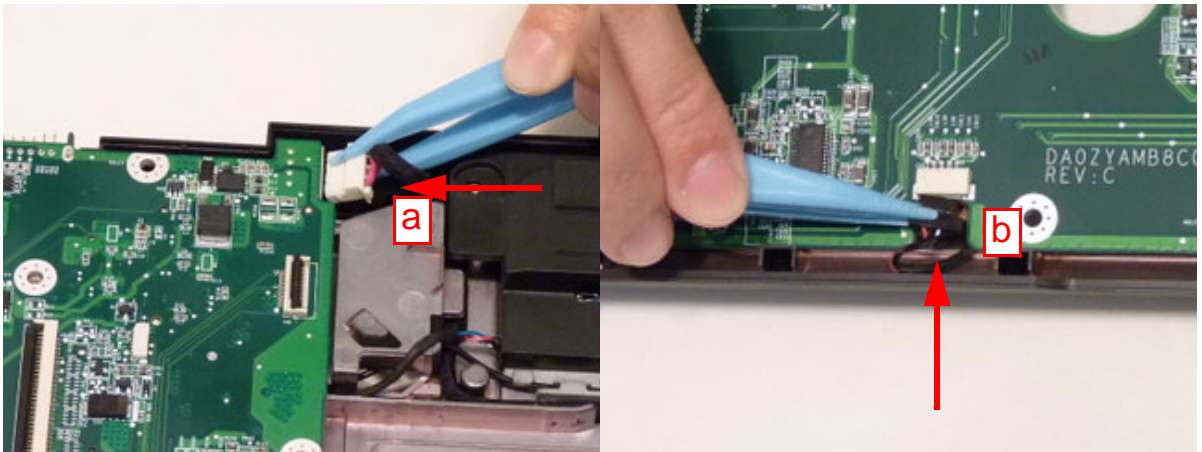
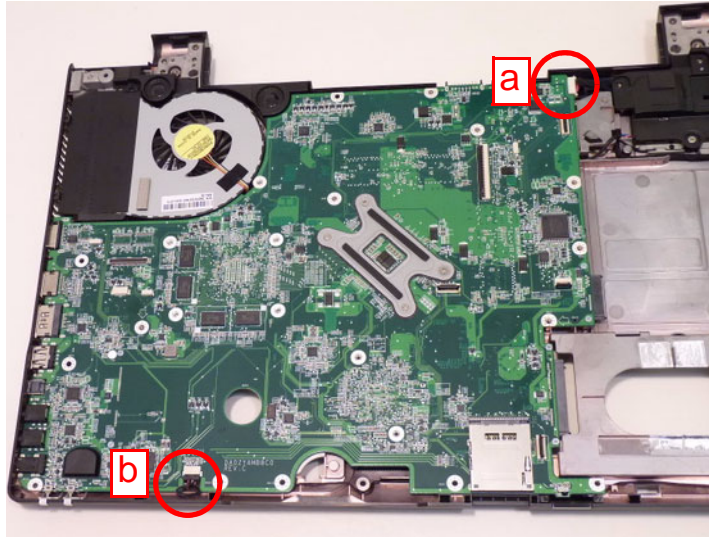

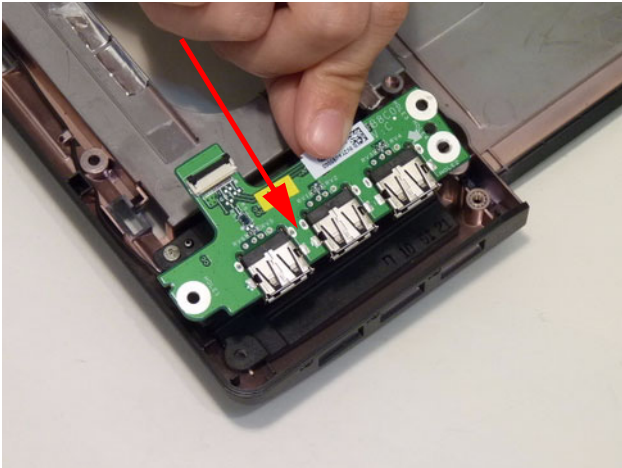

Replacing the USB Board

1. Place the USB board into the lower cover by first lining up the ports with the connector bracket.

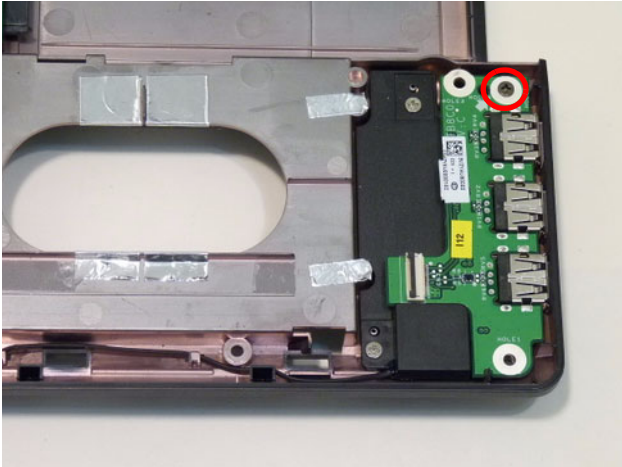

2. Replace the one (1) screw.



Step	Screw	Quantity	Screw Type.
USB Module Assembly	M2.5*6	1	

3. Connect and lock the USB board FFC to the USB board.

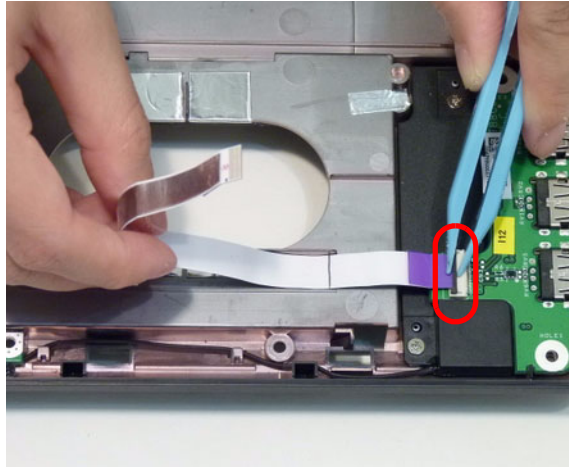

4. Press down on the FFC to adhere it to the lower cover.

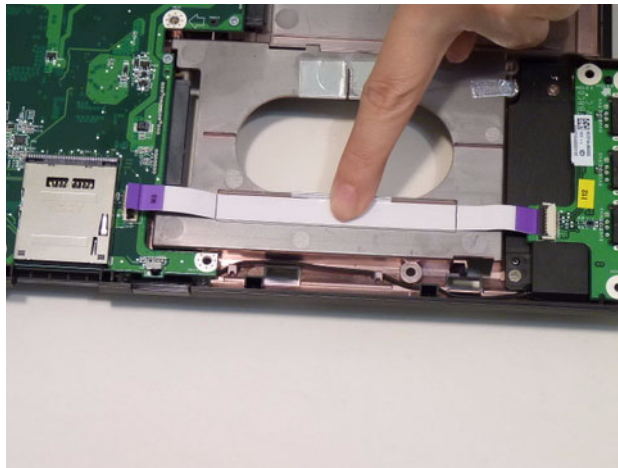

5. Connect and lock the USB board FFC to the mainboard.

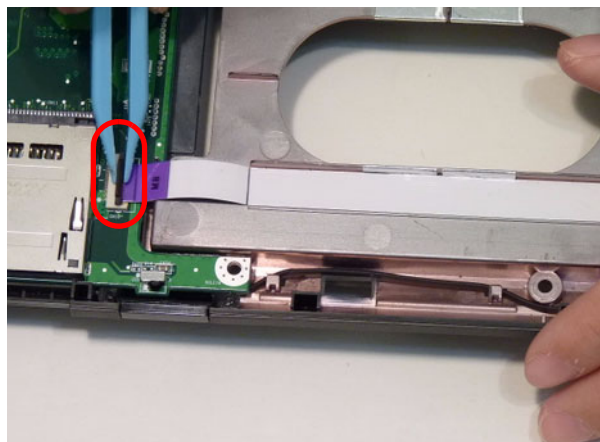



Replacing the LAN Board

- 1. Place the LAN board onto the lower cover.

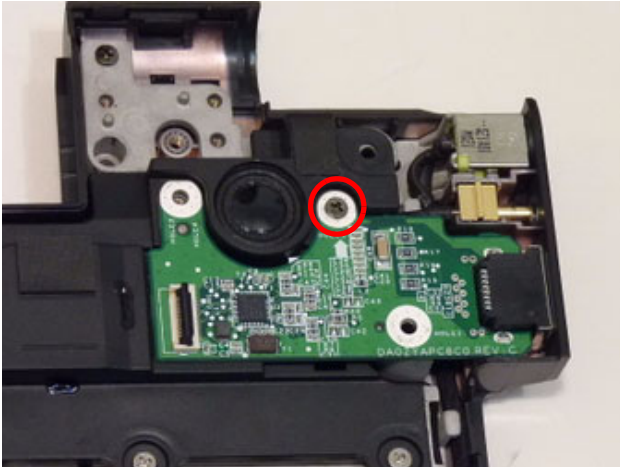

- 2. Replace the one (1) screw.



Step	Screw	Quantity	Screw Type.
LAN Module Assembly	M2.5*6	1	

3. Connect and lock the LAN board FFC to the LAN board.

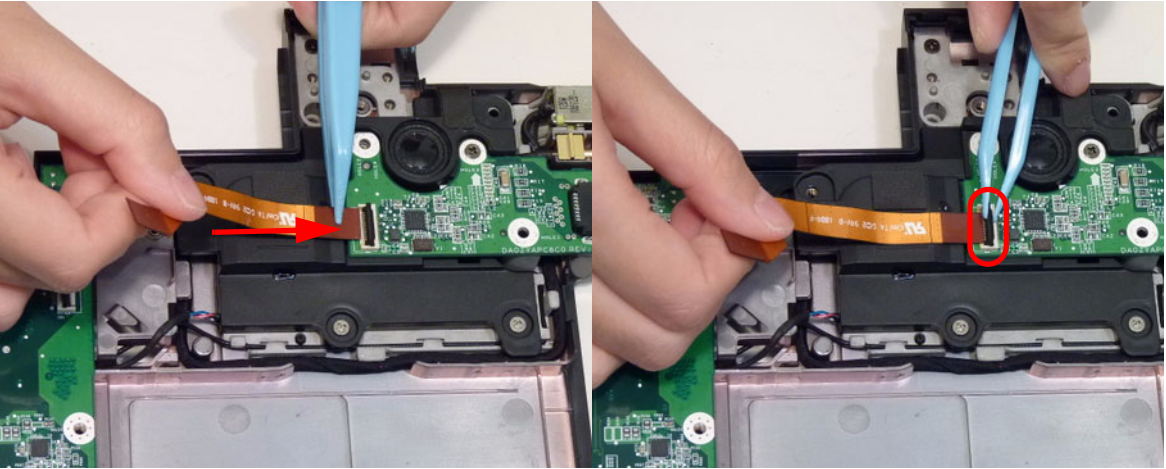

4. Press down on the FFC to adhere it to the lower cover.

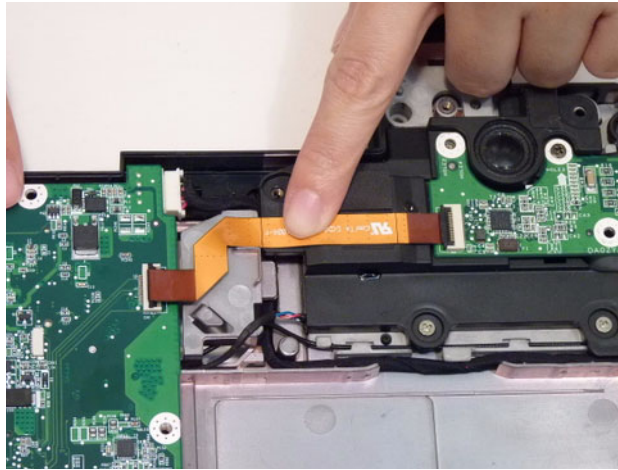

5. Connect and lock the LAN board FFC to the mainboard.

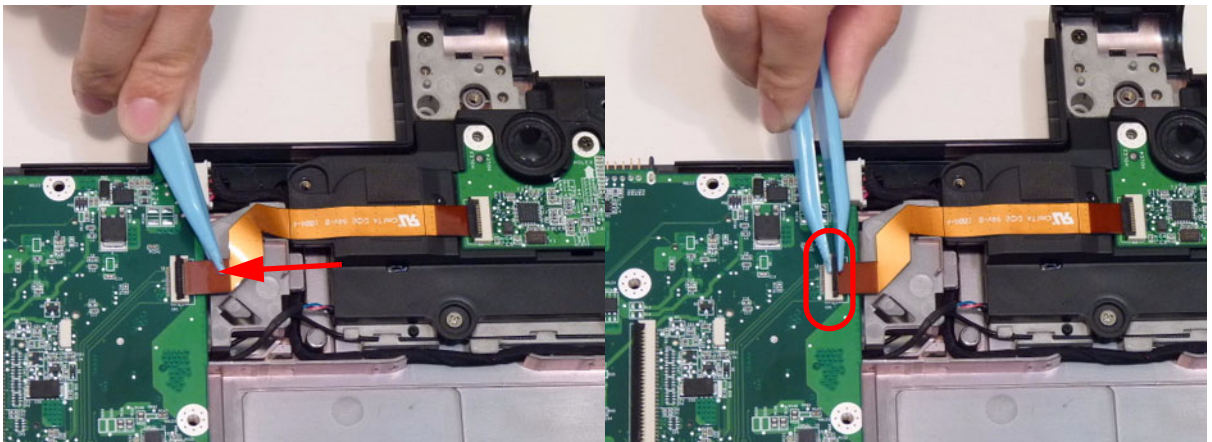

Replacing the Finger Print Board

1. Place the finger print board on the upper cover.

CAUTION: Do not handle the finger print board with excessive force or else damage may occur.



2. Place the finger print bracket on the finger print board.

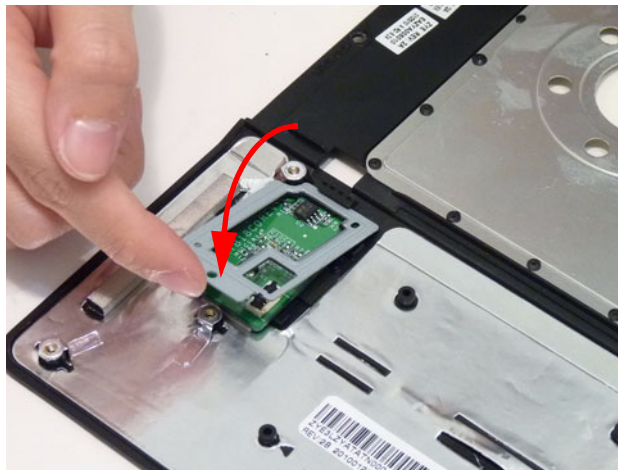

3. Replace the one (1) screw.



Step	Screw	Quantity	Screw Type.
Finger Print Module Assembly	M2*3	1	

4. Connect and lock the finger print board FFC.

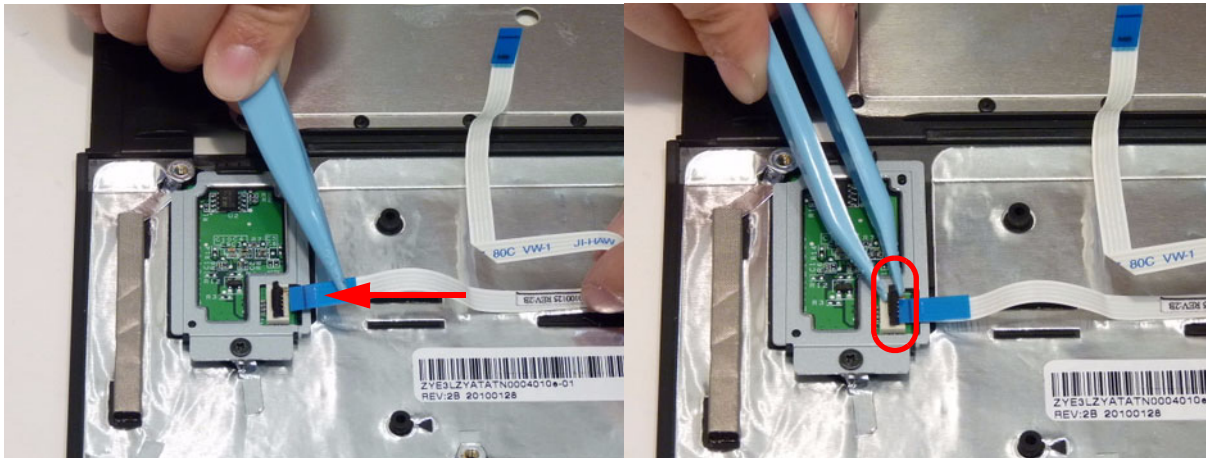

5. Adhere the cable to the upper cover.

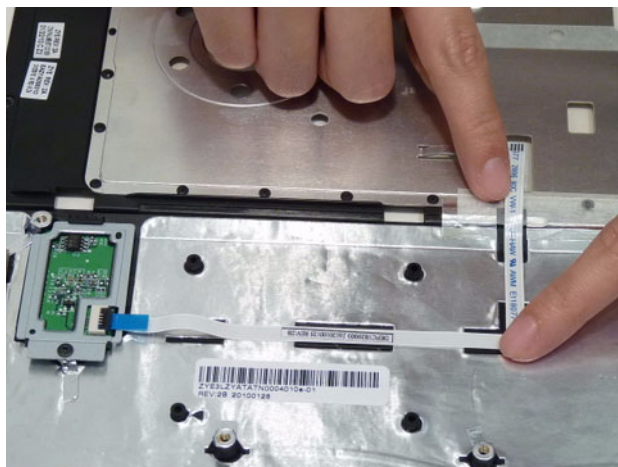

6. Feed the end of the cable through the upper cover as shown.

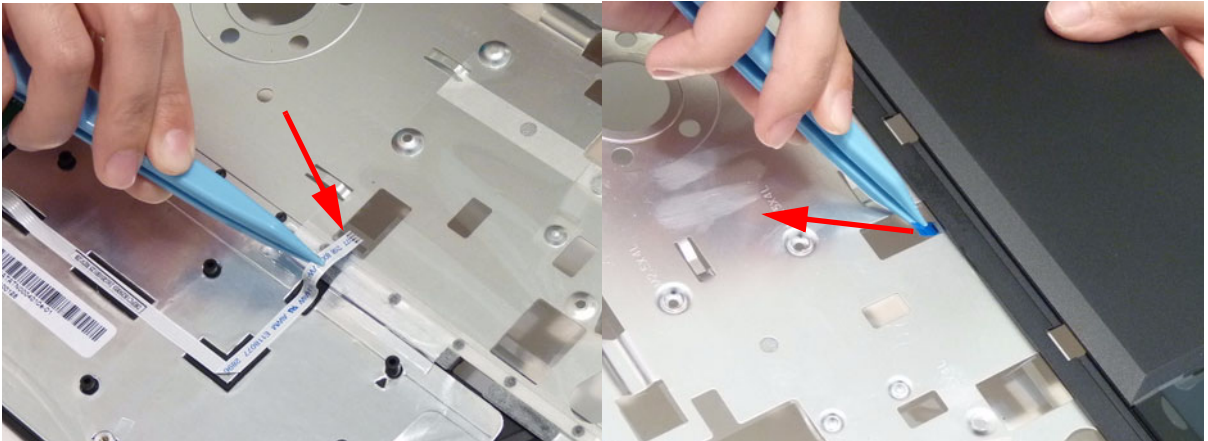

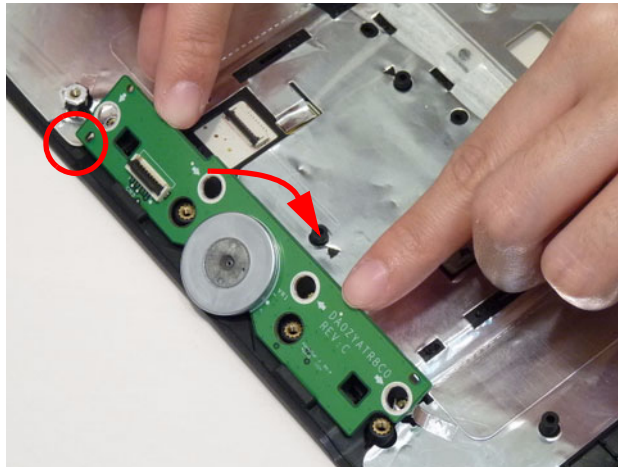

Replacing the Touchpad Board

1. Line up the touchpad board with the guide pin while lowering the board into place.

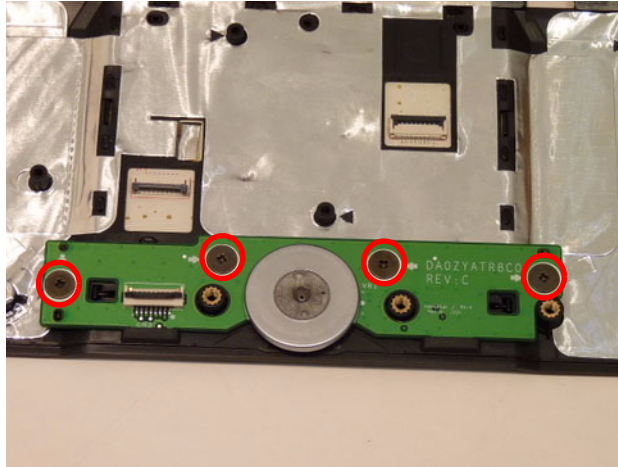

2. Replace the four (4) screws.



Step	Screw	Quantity	Screw Type.
Touchpad Module Assembly	M2-0.4*2	4	

3. Connect and lock the touchpad cable as shown.

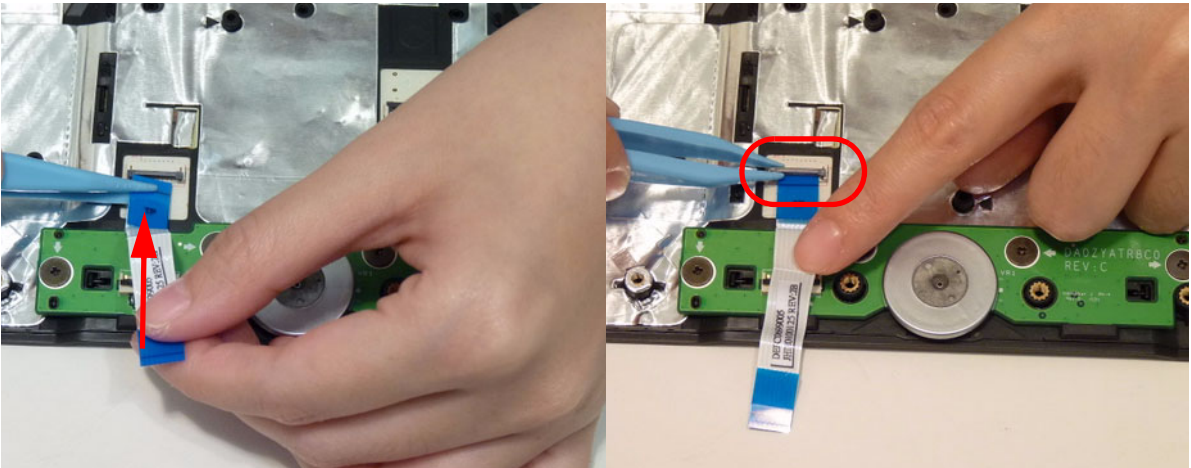

4. Connect and lock the opposite end of the touchpad cable as shown.

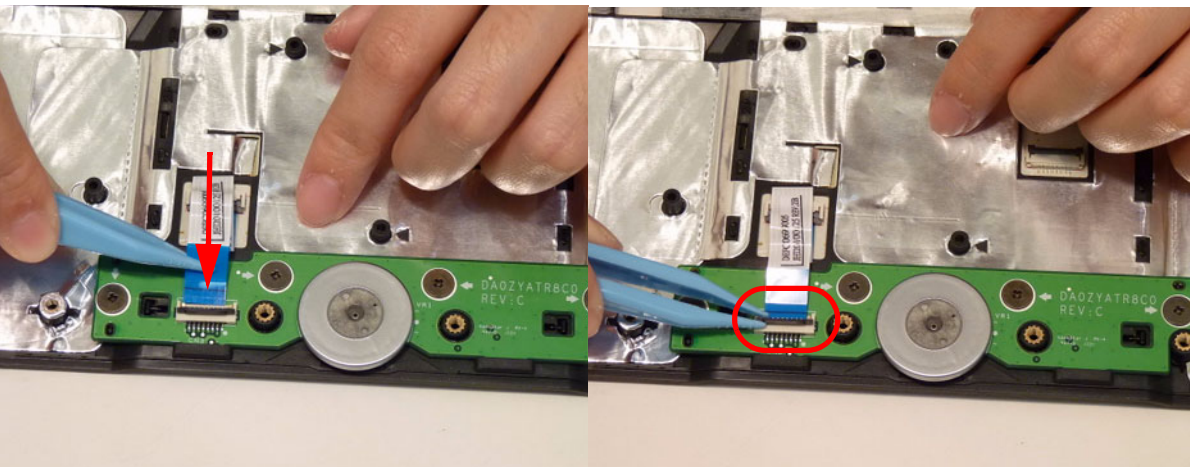

5. Use a strip of adhesive tape to secure the cable.

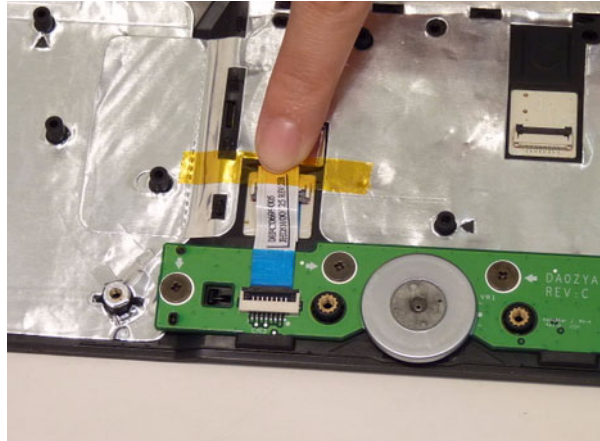

Replacing the Mainboard to Touchpad Cable

1. Connect and lock the mainboard to touchpad cable.

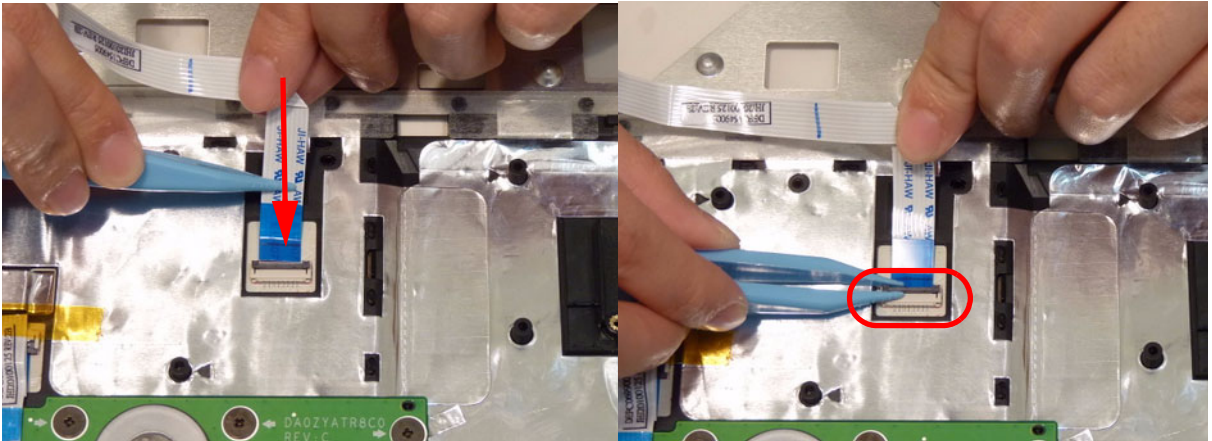

2. Apply a strip of adhesive tape to secure the cable.

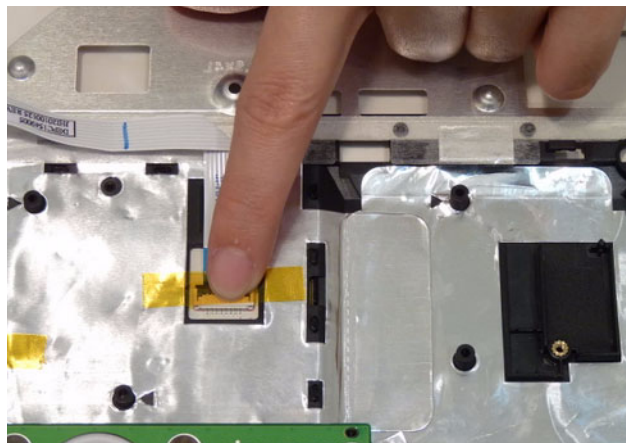

3. Press down on the cable to secure the adhesive to the upper cover.

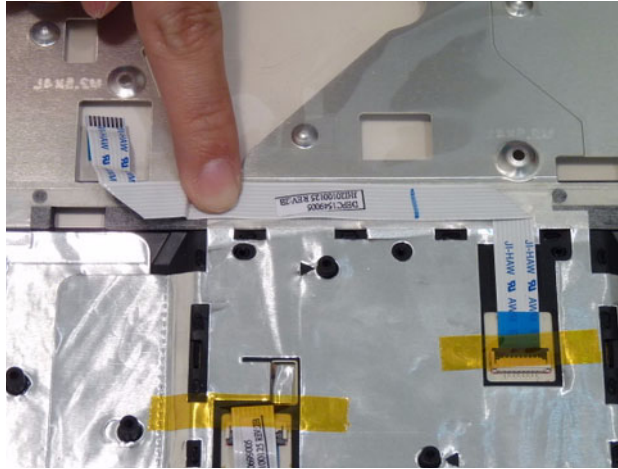

4. Feed the cable through the upper cover as shown.

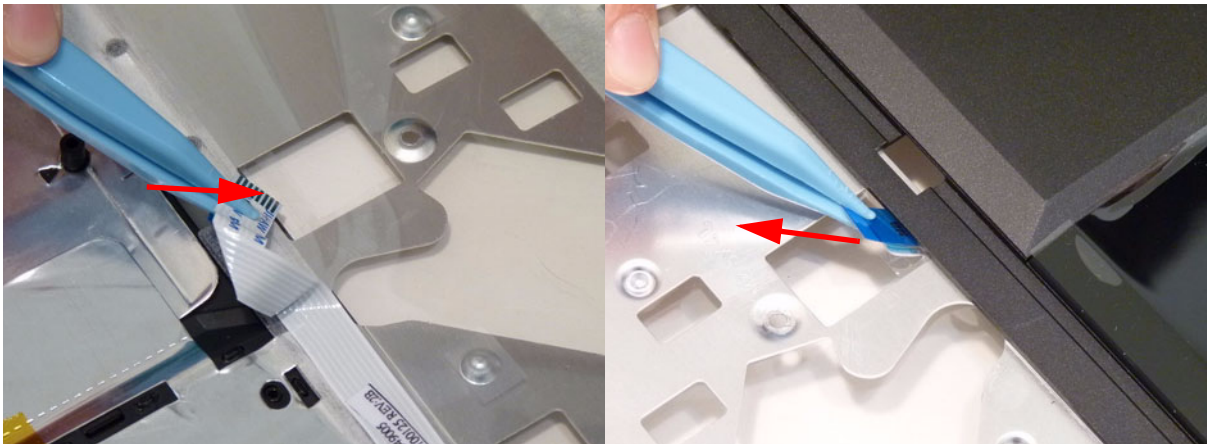

Replacing the Bluetooth Module

1. Connect the Bluetooth cable to the Bluetooth module.

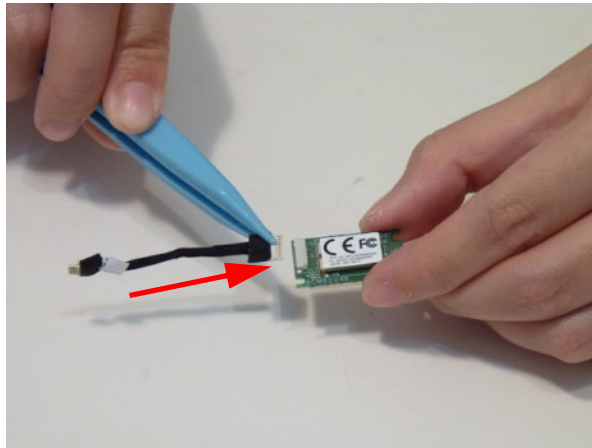

2. Place the Bluetooth module onto the mainboard.

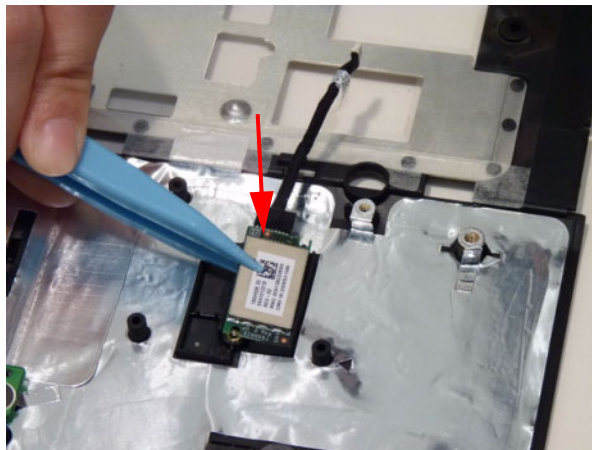

3. Replace the one (1) screw.



Step	Screw	Quantity	Screw Type.
Bluetooth Module Assembly	M2*3	1	

4. Place the cable in the cable clip as shown

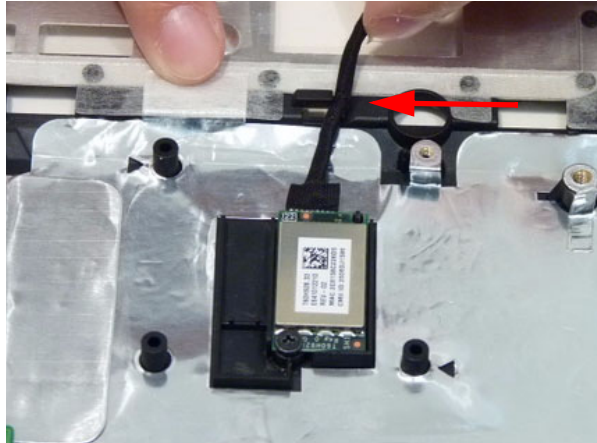

5. Apply a strip of adhesive tape to secure the cable to the upper cover.

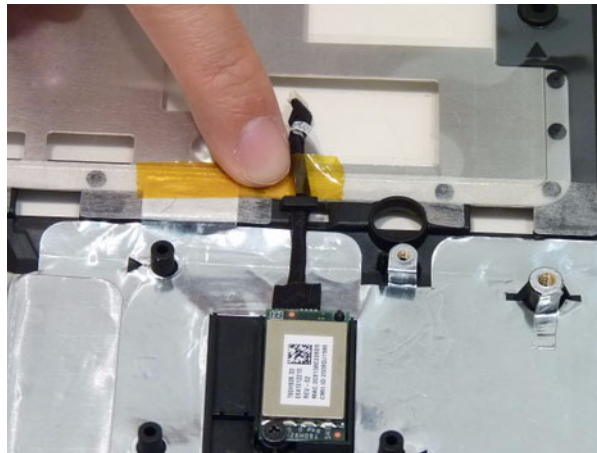

Replacing the Microphone Cable

- 1. Place the microphone cable on the upper cover.

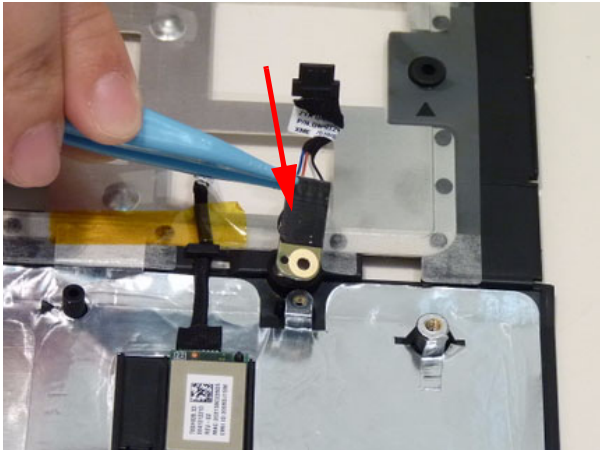

- 2. Replace one (1) screw to secure the assembly.



Step	Screw	Quantity	Screw Type
Microphone Cable Assembly	M2*3	1	

Replacing the Upper Cover and LCD Module

1. Place the upper cover on the lower cover by first lining up the bottom edge as shown.

IMPORTANT:The touchpad board dial must be inserted through the lower casing in order for the cover to sit correctly.



2. Press down on all edges and corners of the assembly so the latches are locked and the top cover sits flush with the bottom cover.

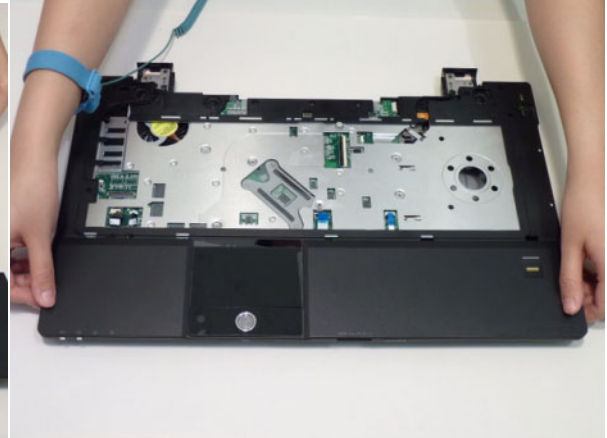
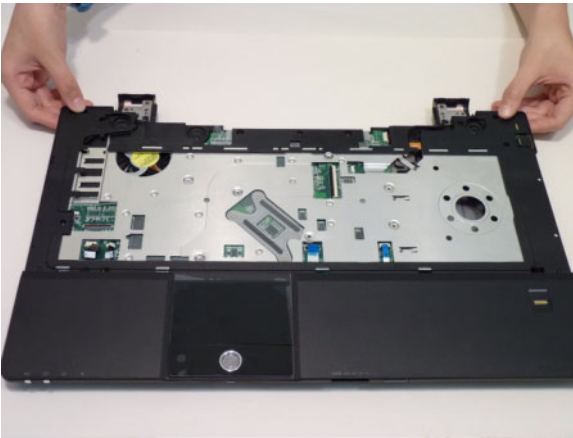

3. Place the LCD module on the chassis.

CAUTION: Make sure all cables are pulled back and away from the device to avoid damage during replacement.

CAUTION: Ensure that the LCD module is stabilized until the hinges are secure to avoid damage to the module.

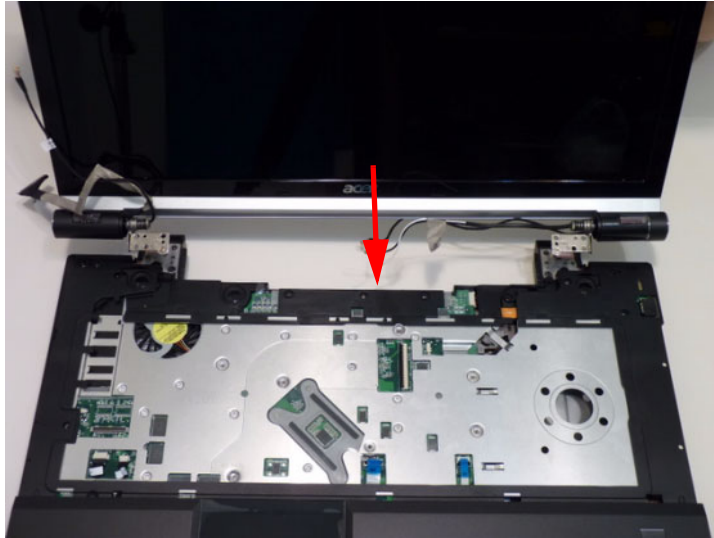

4. Replace the right hinge cap (a) and the left hinge cap (b).

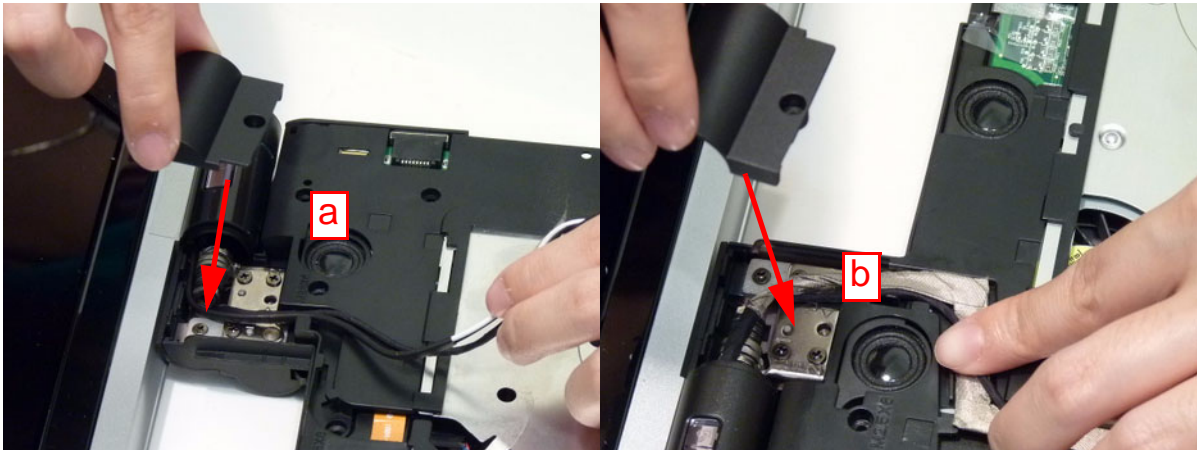

5. Place the WLAN antenna in the cable channel and feed the cable through the chassis.

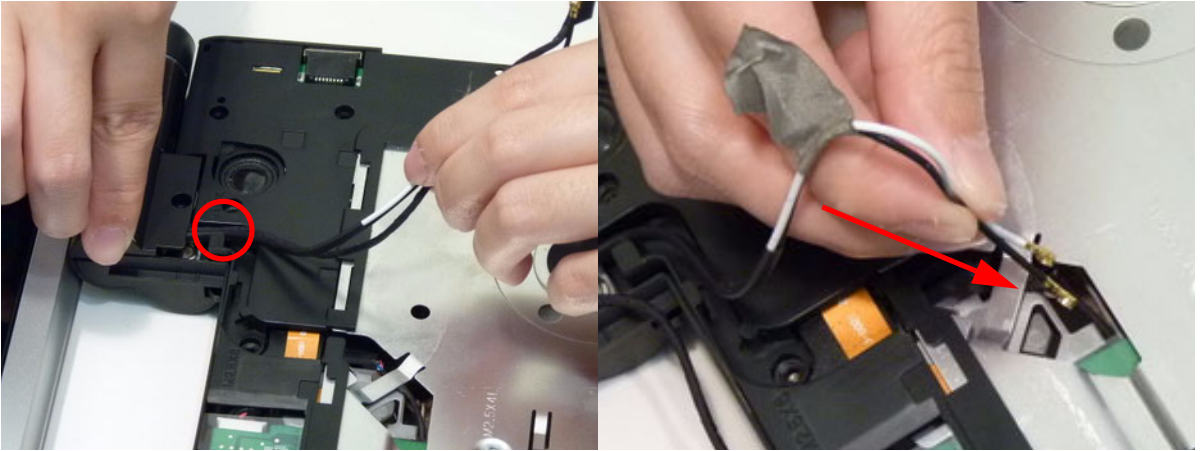

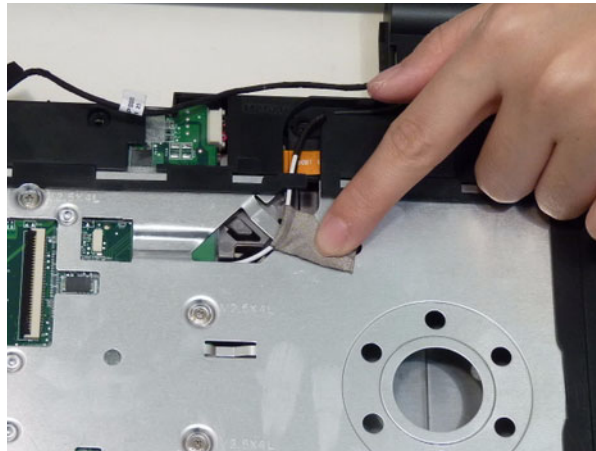

6. Adhere the WLAN cables to the upper cover with the adhesive tape as shown.

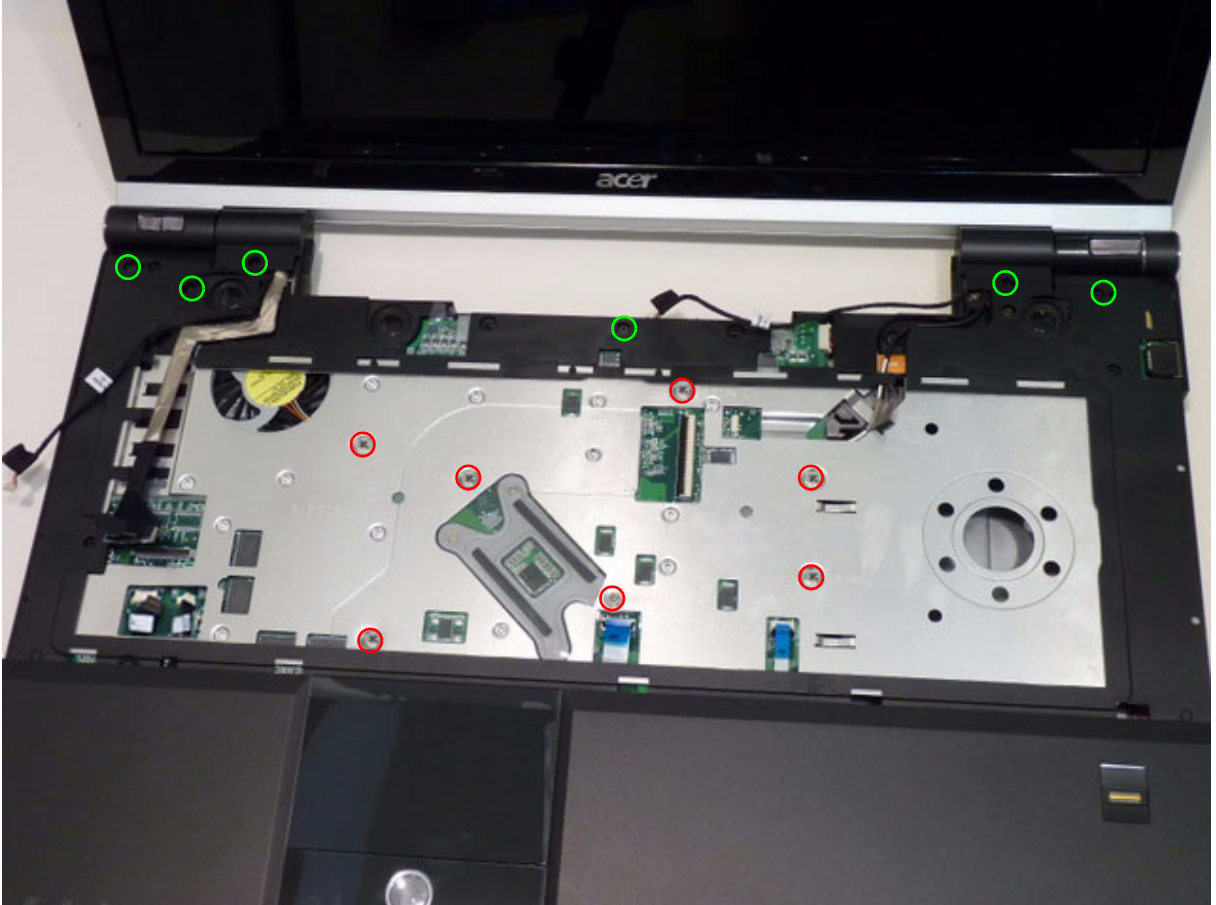

7. Replace the thirteen (13) screws to secure the upper cover and left and right hinges.



Step	Screw	Quantity	Screw Type
Upper Cover Assembly (red callout)	M2.5*4	7	
Upper Cover Assembly (green callout)	M2.5*6	6	

8. Connect the Bluetooth cable (a) and the microphone cable (b).

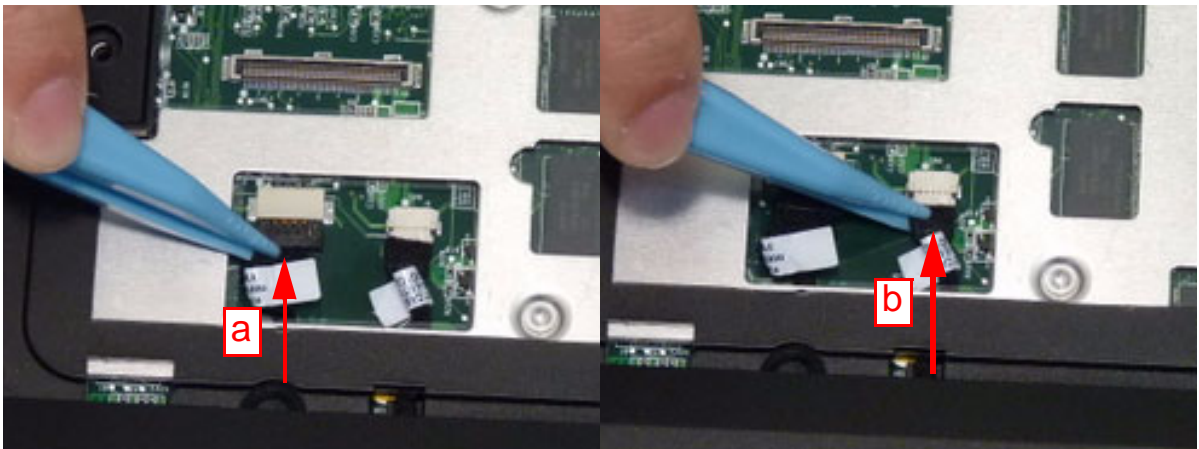

9. Connect the power cable.

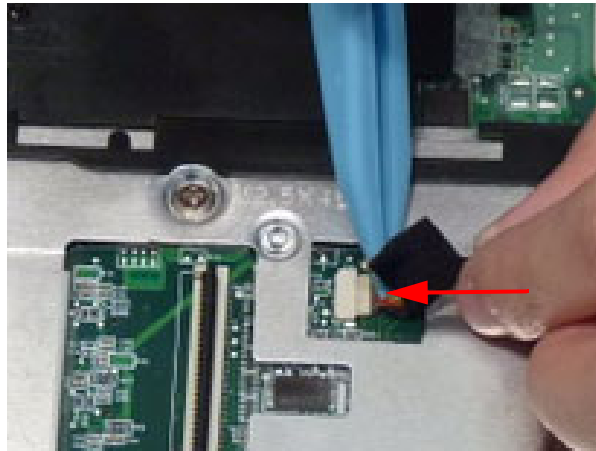

10. Connect and lock the speaker cable.

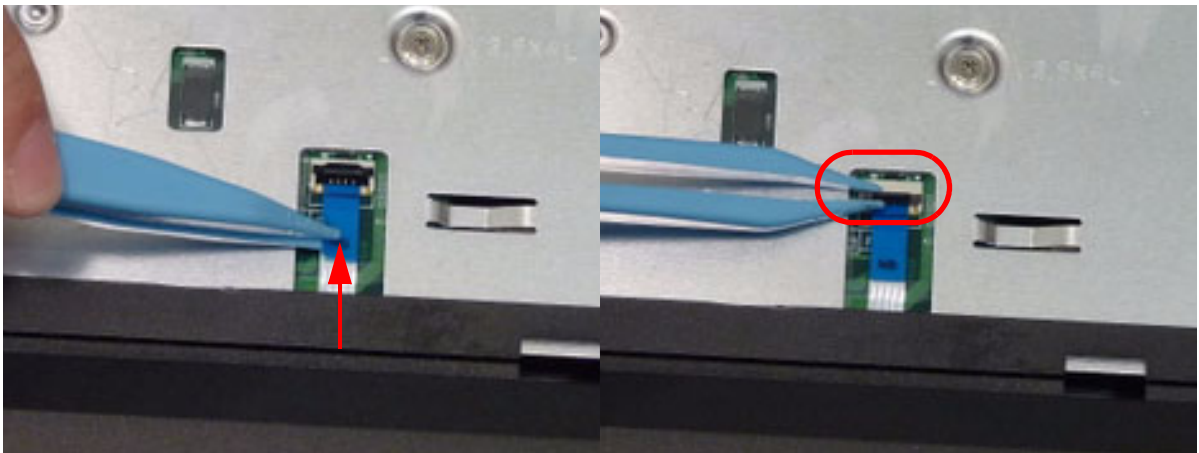

11. Connect and lock the touchpad board FFC.



12. Adhere the LVDS cable to the upper cover as shown.

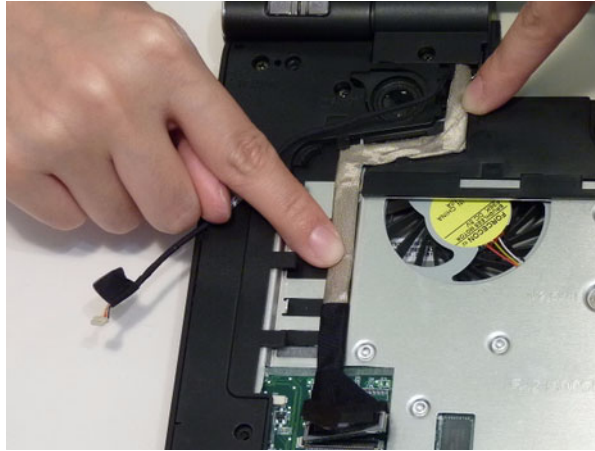

13. Line up the LVDS cable with the connector and press down to lock.

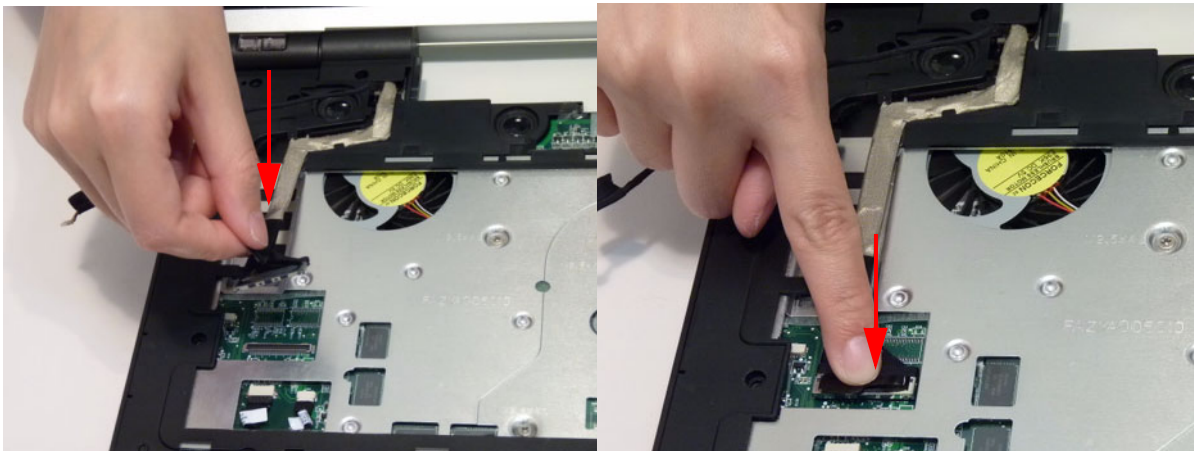

14. Run the power board cable through the cable channel.

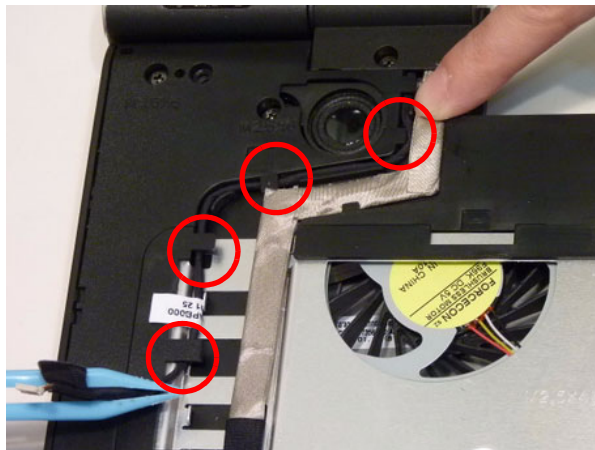

15. Connect the power board cable to the connector

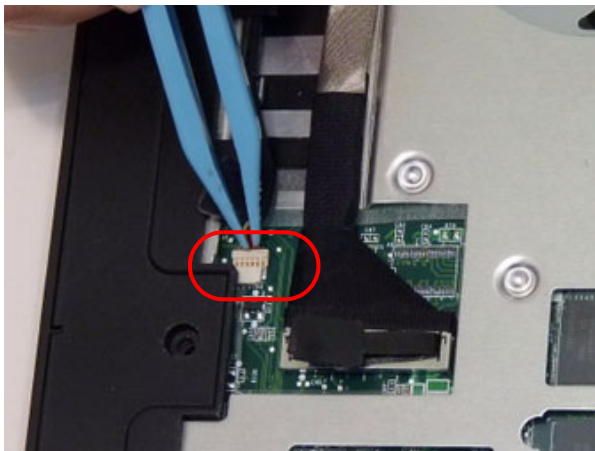

Replacing the Keyboard

1. Replace the six (6) screws to secure the keyboard frame to the module.



Step	Screw	Quantity	Screw Type
Keyboard Module Assembly	M1.6*1.35	6	

2. Connect and lock the keyboard FPC.

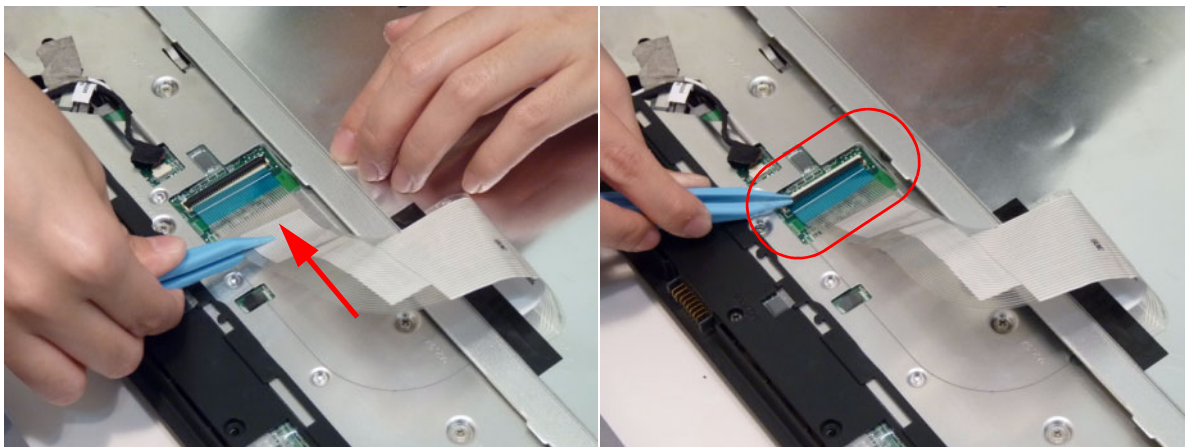



3. Replace the keyboard by first lining up the bottom edge, then lower the keyboard into place.

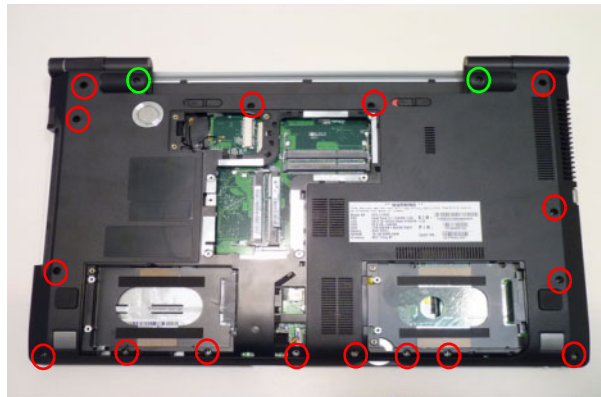

4. Replace eighteen (18) screws in the lower cover.



Step	Screw	Quantity	Screw Type
Lower Cover Assembly	M2.5*6 (red callout)	16	
	M2.5*2.3 (green callout)	2	

Replacing the ODD Module

1. Replace the ODD bezel.



2. Replace the ODD bracket.

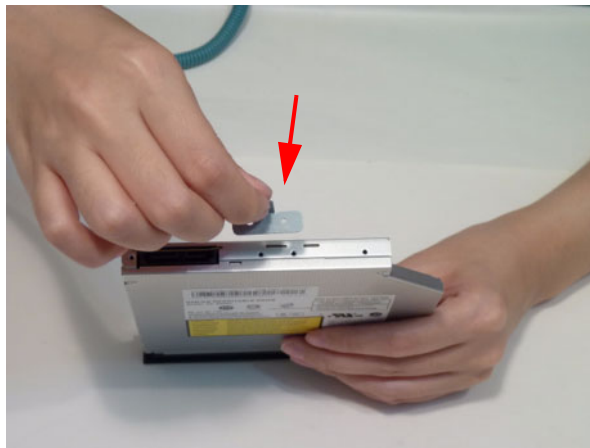

3. Replace the two (2) screws to secure the ODD bracket.



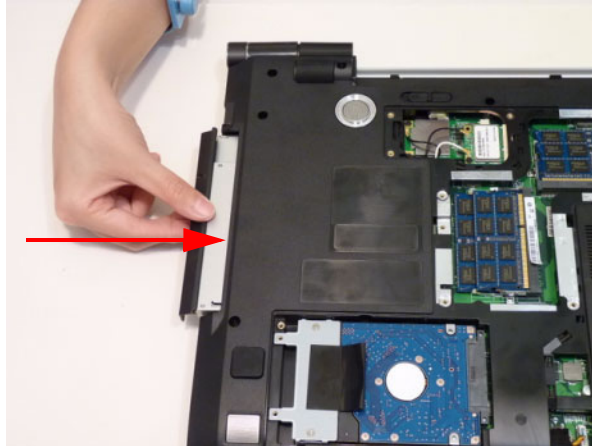

Step	Screw	Quantity	Screw Type
ODD Bracket Assembly	M2*3	2	

4. Push the ODD completely into the bay until flush with the lower cover.

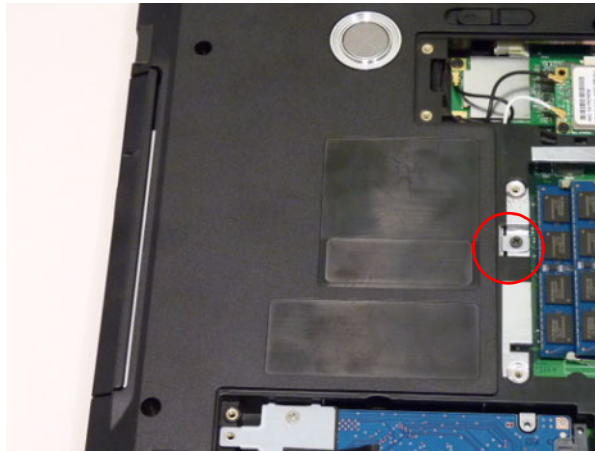

5. Replace one (1) screw to secure the ODD module.



Step	Screw	Quantity	Screw Type
ODD Module Assembly	M2.5*6	1	

Replacing the Slave HDD Module

- 1. Place the HDD bracket onto the HDD.

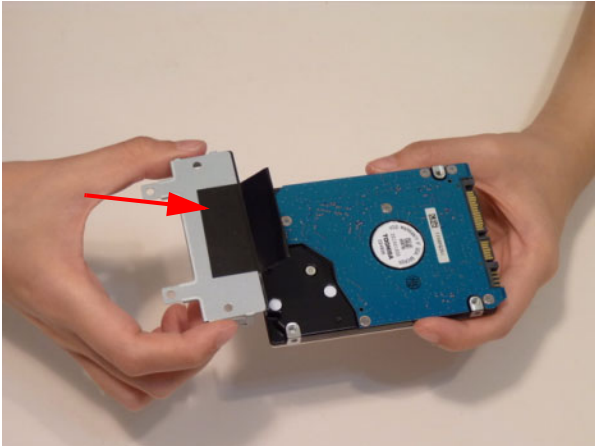

- 2. Replace the two (2) screws.

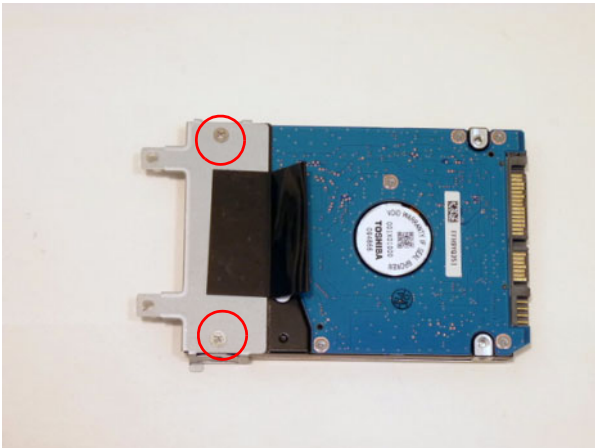

Step	Size	Quantity	Screw Type
Slave HDD Bracket Assembly	M3*3.5 Ni	2	

- 3. Insert the Slave HDD into the bay.

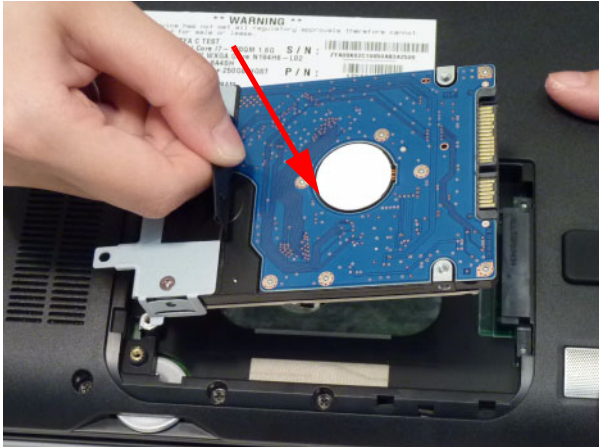

- Grasp the tab and slide the HDD firmly into the docking connector.

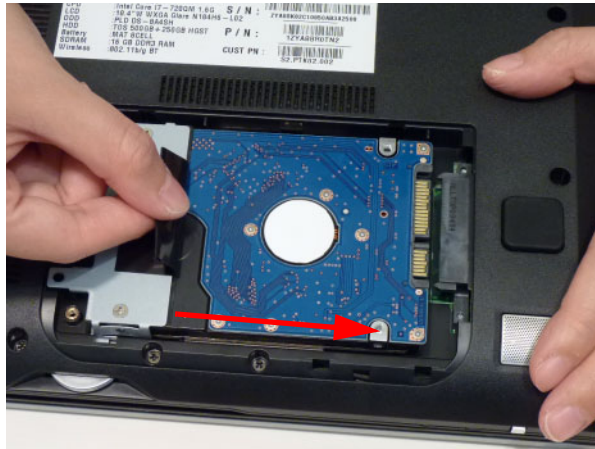

- Replace the two (2) screws to secure the HDD connector.





Step	Screw	Quantity	Screw Type
Slave HDD Module Assembly	M2*5	2	

- Replace the Slave HDD module door by first lining up the right edge as shown.

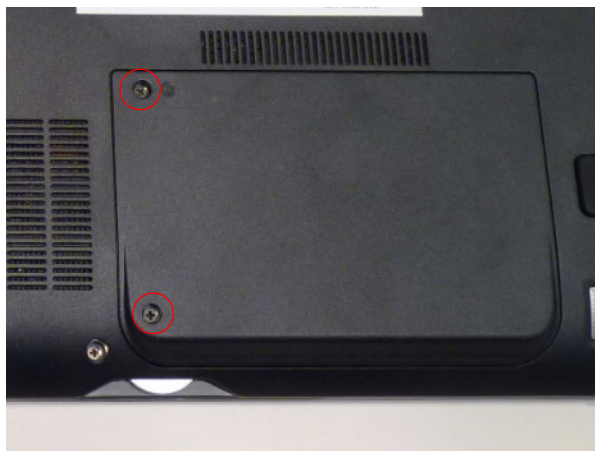

7. Replace the two (2) screws to secure the Slave HDD module door.



Step	Screw	Quantity	Screw Type
Slave HDD Door Assembly	M2.5*6	2	

Replacing the TV Tuner Module

- 1. Insert the TV Tuner module in the connector.

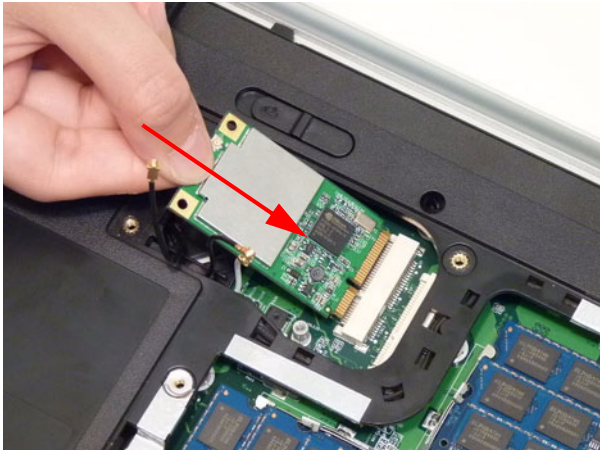

- 2. Replace the one (1) screw. Ensure that the cables are well clear of the module.



Step	Screw	Quantity	Screw Type
TV Tuner Module Assembly	M2*3	1	

- 3. Connect the TV tuner antenna cable as shown.

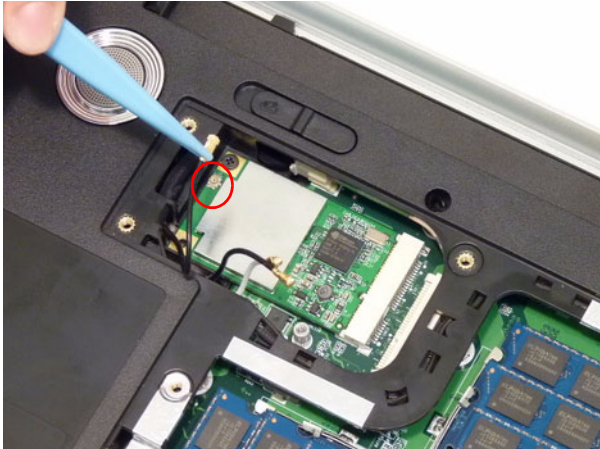

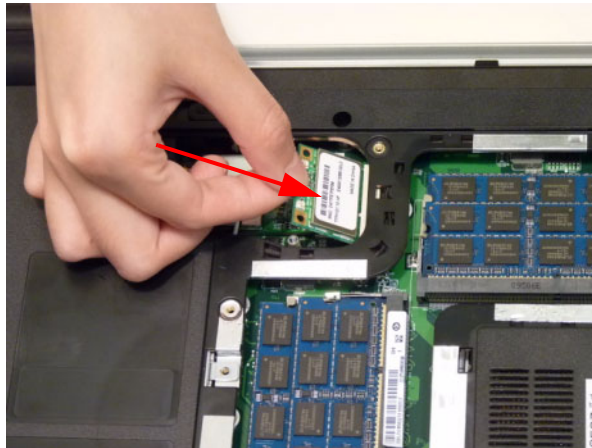

Replacing the Wireless LAN Module

1. Insert the WLAN module into the connector.

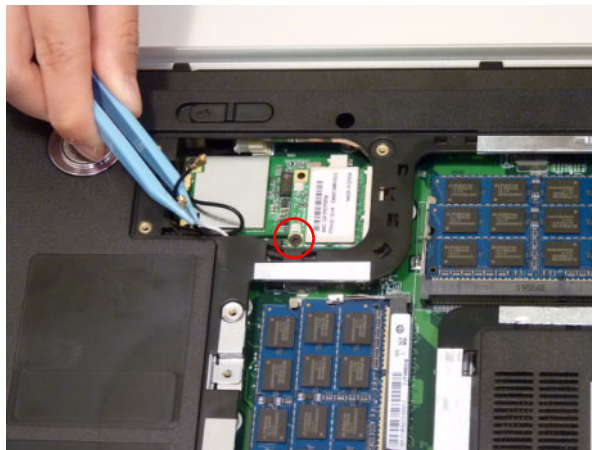

2. Replace the one (1) screw.



Step	Screw	Quantity	Screw Type
WLAN Module Assembly	M2.5*3Ni	1	

3. Connect the WLAN antenna cables.

IMPORTANT: Take note that the Main (black) connector is closest to the LCD module and the Auxiliary (white) connector is closest to the ODD module.

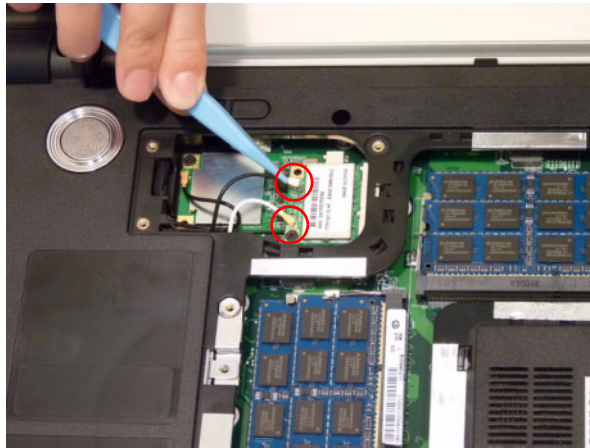

Replacing the DIMM Module

1. Slide the DIMM module into the connector.

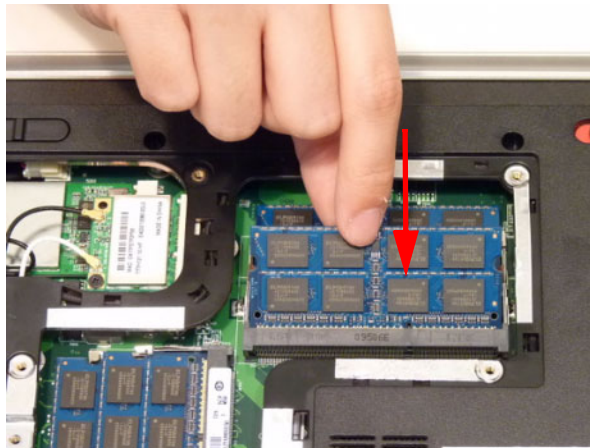

2. Press down until the locking springs click into place.

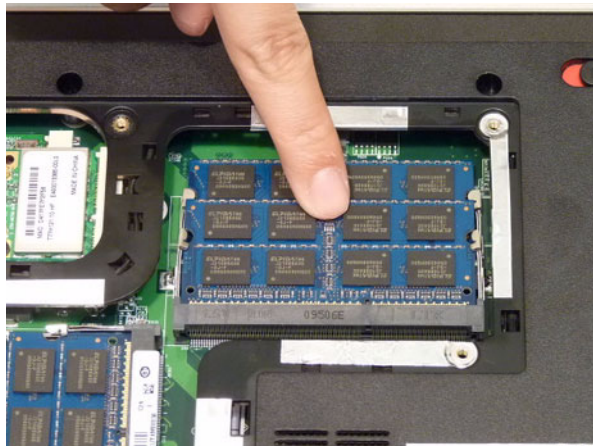

3. Repeat step 1. and 2. for any remaining DIMM modules.

Replacing the Hard Disk Drive

- 1. Place the HDD bracket onto the HDD.

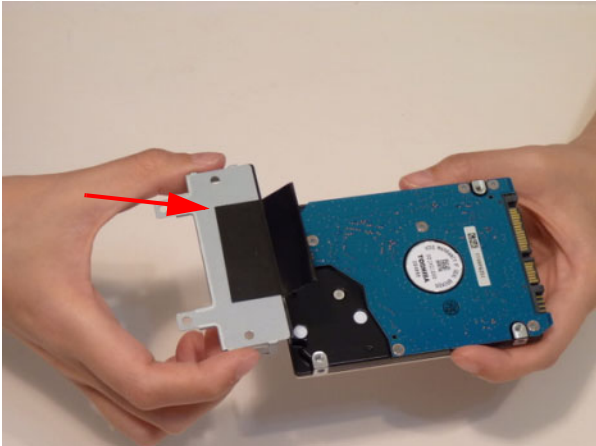

- 2. Replace the two (2) screws to secure the HDD bracket.

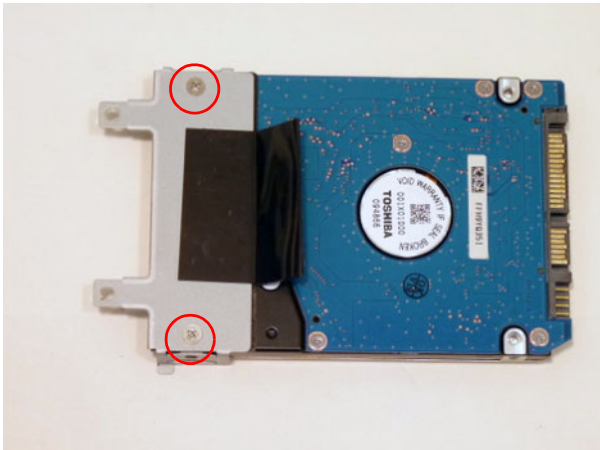

Step	Screw	Quantity	Screw Type
Master HDD Bracket Assembly	M3*3.5 Ni	2	

- 3. Insert the HDD into the bay.

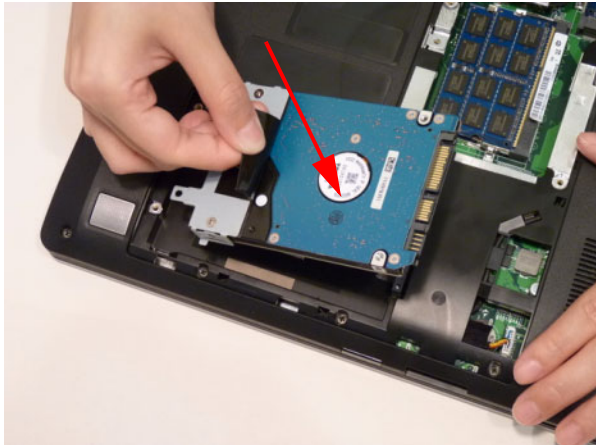

4. Grasp the tab and slide the HDD firmly into the docking connector.

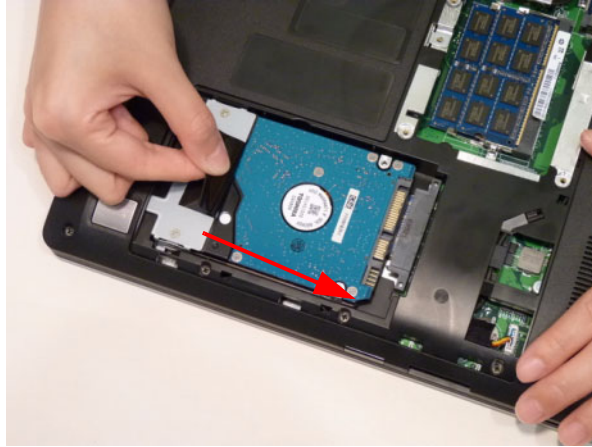

5. Replace two (2) screws to secure the HDD connector.

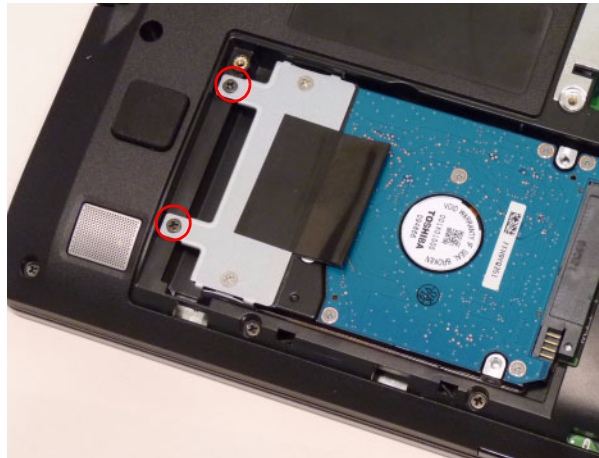

Step	Screw	Quantity	Screw Type
Master HDD Module Assembly	M2*5	2	

Replacing the Base Door

1. Insert the base door edge flanges into the slots.



2. Replace the nine (9) screws.

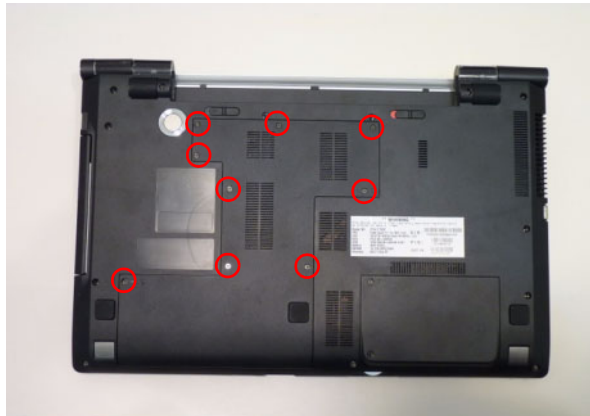

Replacing the Dummy Card

1. Insert the dummy card in until it clicks into place.



Replacing the Battery

1. Hold the release latch in the release position (1) and slide the battery into place (2).

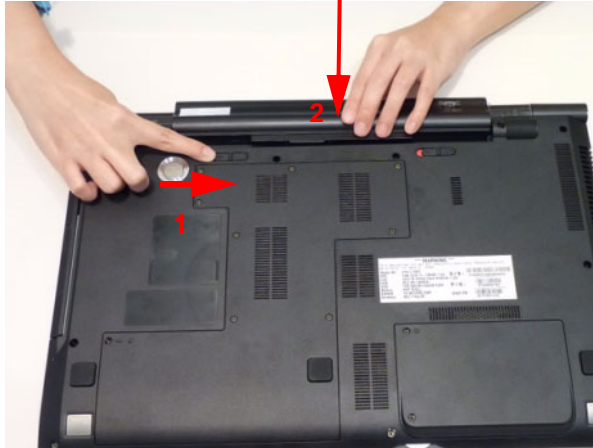

2. Close the locking latch.



Troubleshooting

Common Problems

Use the following procedure as a guide for computer problems.

NOTE: The diagnostic tests are intended to test only Acer products. Non-Acer products, prototype cards, or modified options can give false errors and invalid system responses.

1. Obtain the failing symptoms in as much detail as possible.
2. Verify the symptoms by attempting to re-create the failure by running the diagnostic test or by repeating the same operation.
3. Use the following table with the verified symptom to determine which page to go to.

Symptoms (Verified)	Go To
Power On Issue	Page 172
No Display Issue	Page 173
LCD Failure	Page 175
Internal Keyboard Failure	Page 176
TouchPad Failure	Page 177
Internal Speaker Failure	Page 178
Internal Microphone Failure	Page 179
USB Failure	Page 181
Other Function Failure	Page 181

4. If the Issue is still not resolved, see "Online Support Information" on page 349.

Power On Issue

If the system doesn't power on, perform the following actions one at a time to correct the problem. Do not replace non-defective FRUs:

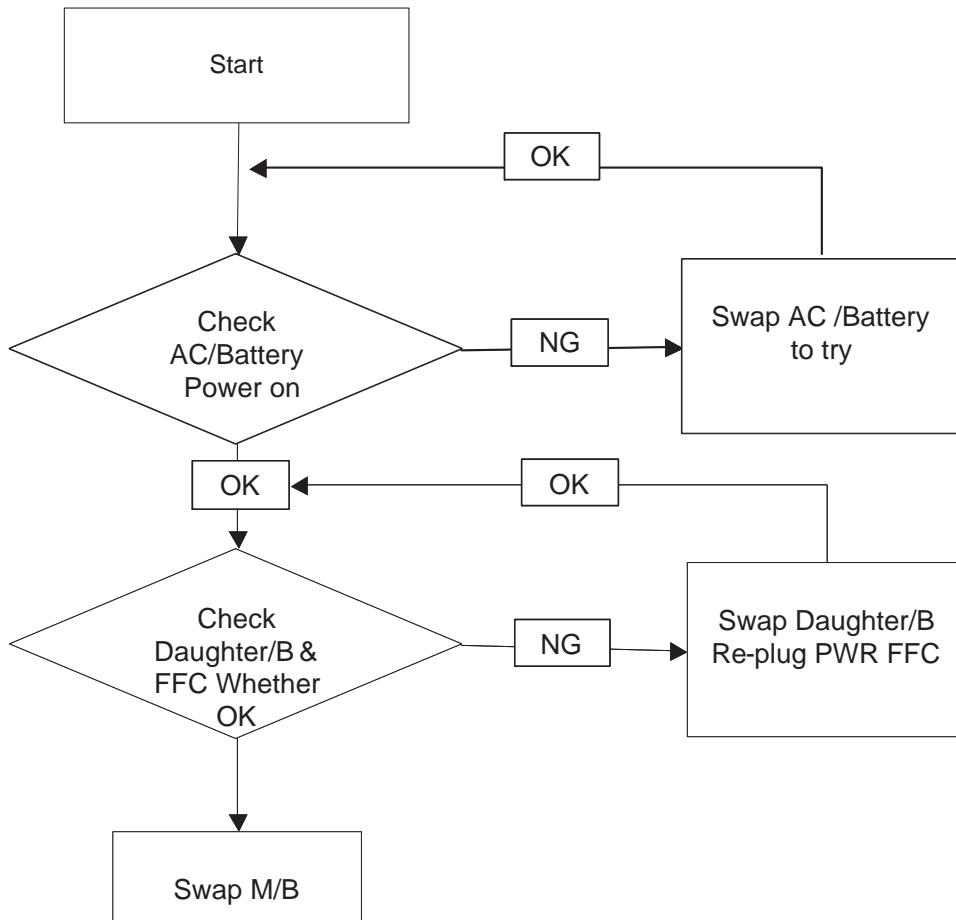

Computer Shuts down Intermittently

If the system powers off at intervals, perform the following actions one at a time to correct the problem.

1. Check the power cable is properly connected to the computer and the electrical outlet.
2. Remove any extension cables between the computer and the outlet.
3. Remove any surge protectors between the computer and the electrical outlet. Plug the computer directly into a known good electrical outlet.
4. Remove all external and non-essential hardware connected to the computer that are not necessary to boot the computer to the failure point.
5. Remove any recently installed software.
6. If the Issue is still not resolved, see "Online Support Information" on page 349.

No Display Issue

If the **Display** doesn't work, perform the following actions one at a time to correct the problem. Do not replace non-defective FRUs:

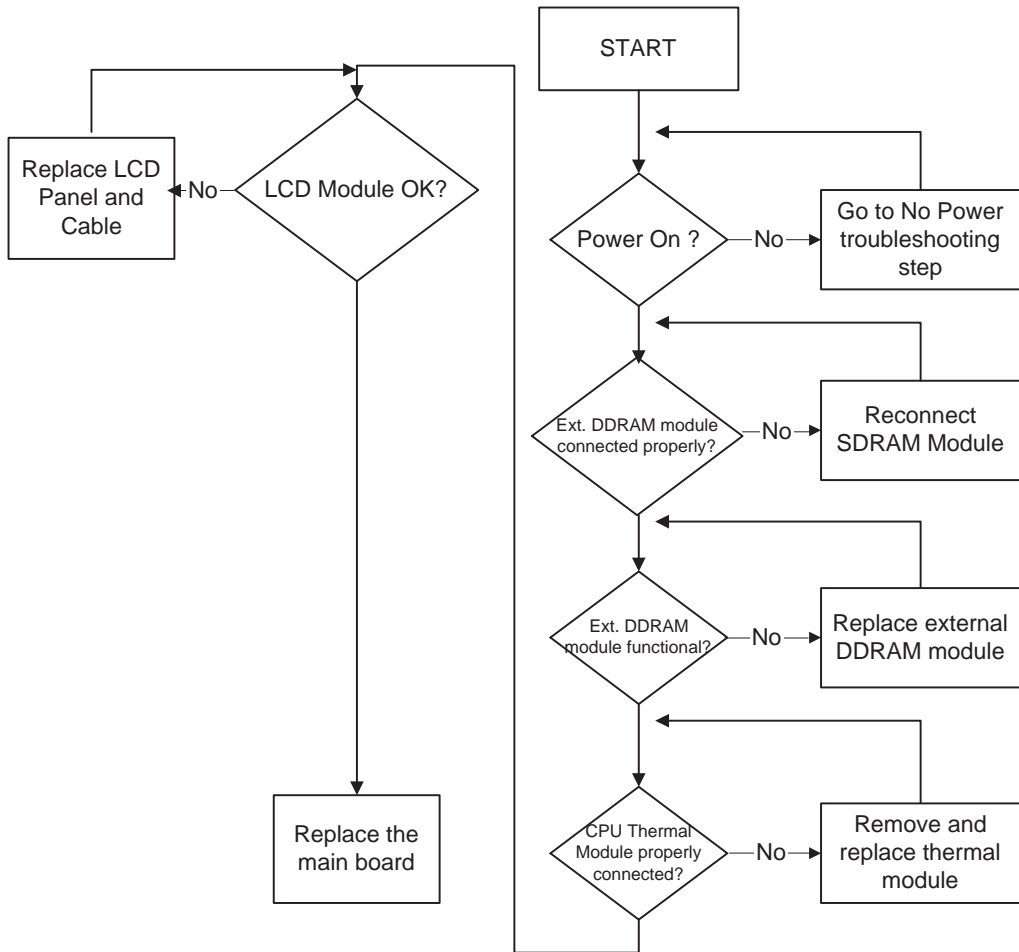

No POST or Video

If the POST or video doesn't display, perform the following actions one at a time to correct the problem.

1. Make sure that the internal display is selected. On this notebook model, switching between the internal display and the external display is done by pressing **Fn+F5**. Reference Product pages for specific model procedures.
2. Make sure the computer has power by checking at least one of the following occurs:
 - Fans start up
 - Status LEDs light up

If there is no power, see "Power On Issue" on page 172.

3. Drain any stored power by removing the power cable and battery and holding down the power button for 10 seconds. Reconnect the power and reboot the computer.
4. Connect an external monitor to the computer and switch between the internal display and the external display is by pressing **Fn+F5** (on this model).

If the POST or video appears on the external display, see "LCD Failure" on page 175.

5. Disconnect power and all external devices including port replicators or docking stations. Remove any memory cards and CD/DVD discs. Restart the computer.

If the computer boots correctly, add the devices one by one until the failure point is discovered.

6. Reseat the memory modules.
7. Remove the drives (see “Disassembly Process” on page 47).
8. If the Issue is still not resolved, see “Online Support Information” on page 349.

Abnormal Video Display

If video displays abnormally, perform the following actions one at a time to correct the problem.

1. Reboot the computer.
2. If permanent vertical/horizontal lines or dark spots display in the same location, the LCD is faulty and should be replaced. See “Disassembly Process” on page 47.
3. If extensive pixel damage is present (different colored spots in the same locations on the screen), the LCD is faulty and should be replaced. See “Disassembly Process” on page 47.
4. Adjust the brightness to its highest level. See the User Manual for instructions on adjusting settings.
NOTE: Ensure that the computer is not running on battery alone as this may reduce display brightness.

If the display is too dim at the highest brightness setting, the LCD is faulty and should be replaced. See “Disassembly Process” on page 47.

5. Check the display resolution is correctly configured:
 - a. Minimize or close all Windows.
 - b. If display size is only abnormal in an application, check the view settings and control/mouse wheel zoom feature in the application.
 - c. If desktop display resolution is not normal, right-click on the desktop and select **Personalize**→ **Display Settings**.
 - d. Click and drag the Resolution slider to the desired resolution.
 - e. Click **Apply** and check the display. Readjust if necessary.
6. Roll back the video driver to the previous version if updated.
7. Remove and reinstall the video driver.
8. Check the Device Manager to determine that:
 - The device is properly installed. There are no red Xs or yellow exclamation marks.
 - There are no device conflicts.
 - No hardware is listed under Other Devices.
9. If the Issue is still not resolved, see “Online Support Information” on page 349.
10. Run the Windows Memory Diagnostic from the operating system DVD and follow the onscreen prompts.
11. If the Issue is still not resolved, see “Online Support Information” on page 349.

Random Loss of BIOS Settings

If the computer is experiencing intermittent loss of BIOS information, perform the following actions one at a time to correct the problem.

1. If the computer is more than one year old, replace the CMOS battery.
2. Run a complete virus scan using up-to-date software to ensure the computer is virus free.
3. If the computer is experiencing HDD or ODD BIOS information loss, disconnect and reconnect the power and data cables between devices.
If the BIOS settings are still lost, replace the cables.
4. If HDD information is missing from the BIOS, the drive may be defective and should be replaced.
5. Replace the Motherboard.

6. If the Issue is still not resolved, see "Online Support Information" on page 349.

LCD Failure

If the **LCD** fails, perform the following actions one at a time to correct the problem. Do not replace non-defective FRUs:

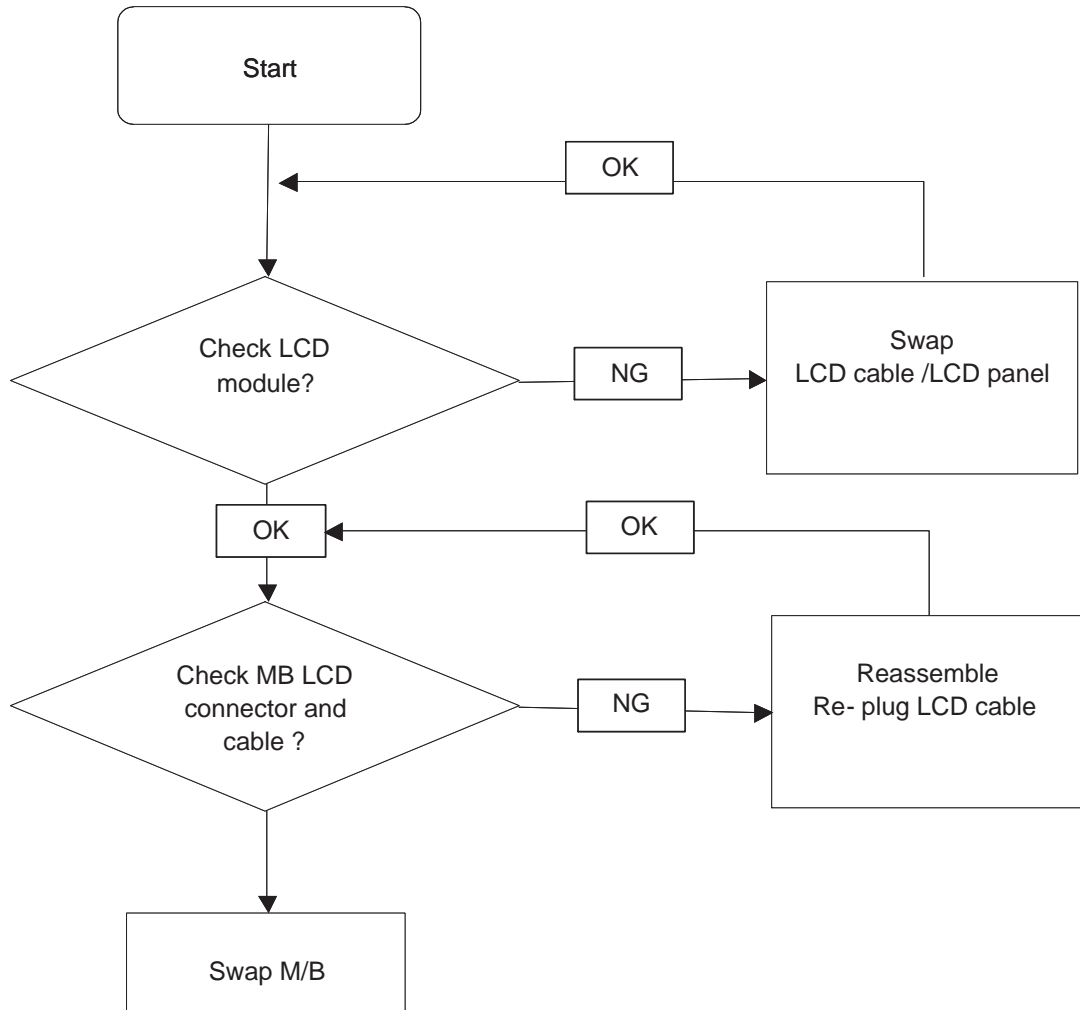

Built-In Keyboard Failure

If the built-in **Keyboard** fails, perform the following actions one at a time to correct the problem. Do not replace non-defective FRUs:

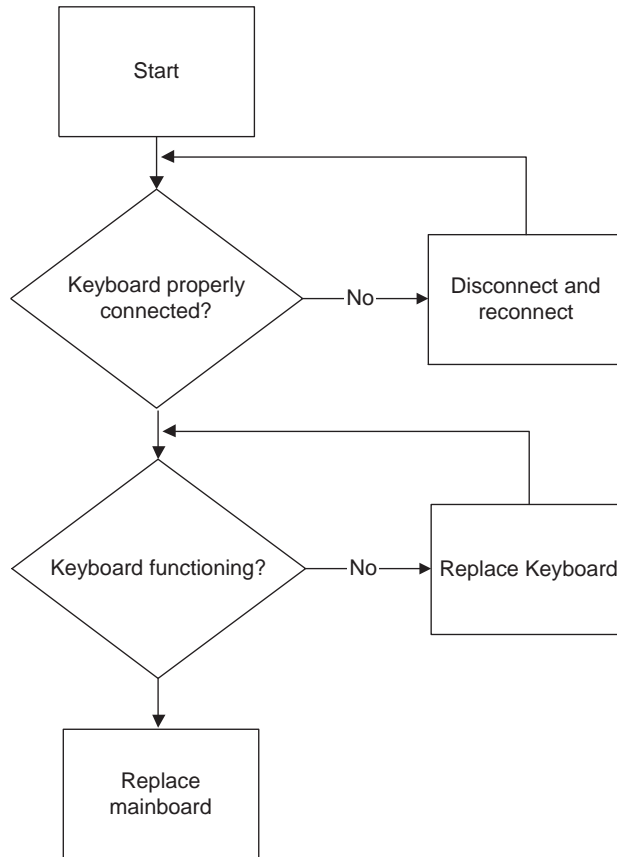

TouchPad Failure

If the **TouchPad** doesn't work, perform the following actions one at a time to correct the problem. Do not replace non-defective FRUs:

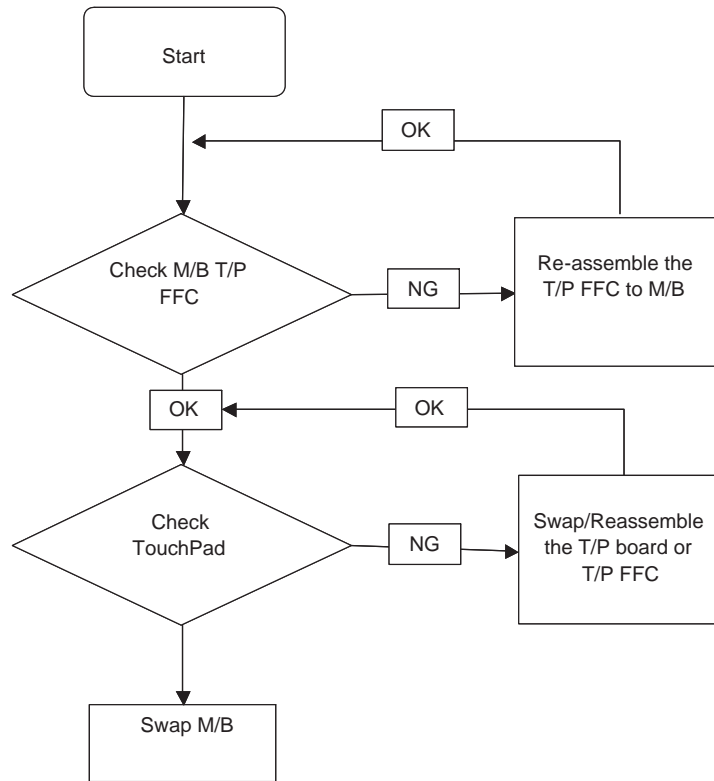

Internal Speaker Failure

If the internal **Speakers** fail, perform the following actions one at a time to correct the problem. Do not replace non-defective FRUs:

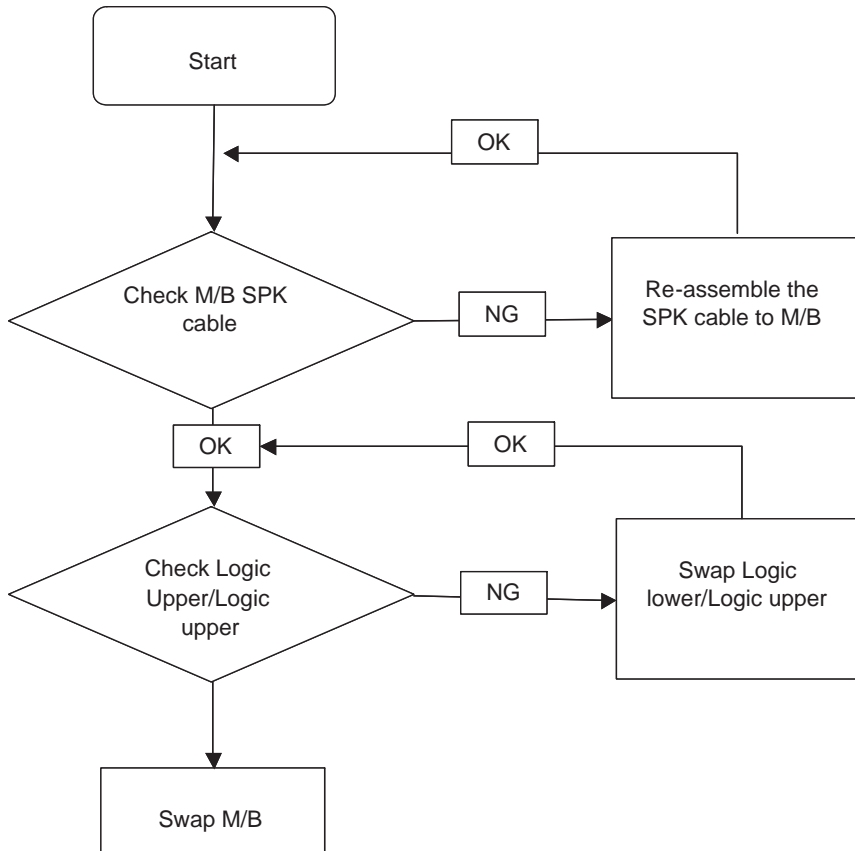

Sound Problems

If sound problems are experienced, perform the following actions one at a time to correct the problem.

1. Reboot the computer.
2. Navigate to **Start** → **Control Panel** → **System and Maintenance** → **System** → **Device Manager**. Check the Device Manager to determine that:
 - The device is properly installed.
 - There are no red Xs or yellow exclamation marks.
 - There are no device conflicts.
 - No hardware is listed under Other Devices.
3. Roll back the audio driver to the previous version, if updated recently.
4. Remove and reinstall the audio driver.
5. Ensure that all volume controls are set mid range:
 - a. Click the volume icon on the taskbar and drag the slider to 50. Ensure that the volume is not muted.
 - b. Click Mixer to verify that other audio applications are set to 50 and not muted.
6. Navigate to **Start** → **Control Panel** → **Hardware and Sound** → **Sound**. Ensure that Speakers are selected as the default audio device (green check mark).

NOTE: If Speakers does not show, right-click on the **Playback** tab and select **Show Disabled Devices** (clear by default).

7. Select Speakers and click **Configure** to start **Speaker Setup**. Follow the onscreen prompts to configure the speakers.
8. Remove and recently installed hardware or software.
9. Restore system and file settings from a known good date using **System Restore**.
If the issue is not fixed, repeat the preceding steps and select an earlier time and date.
10. Reinstall the Operating System.
11. If the Issue is still not resolved, see “Online Support Information” on page 349.

Internal Microphone Failure

If the internal **Microphone** fails, perform the following actions one at a time to correct the problem. Do not replace non-defective FRUs:

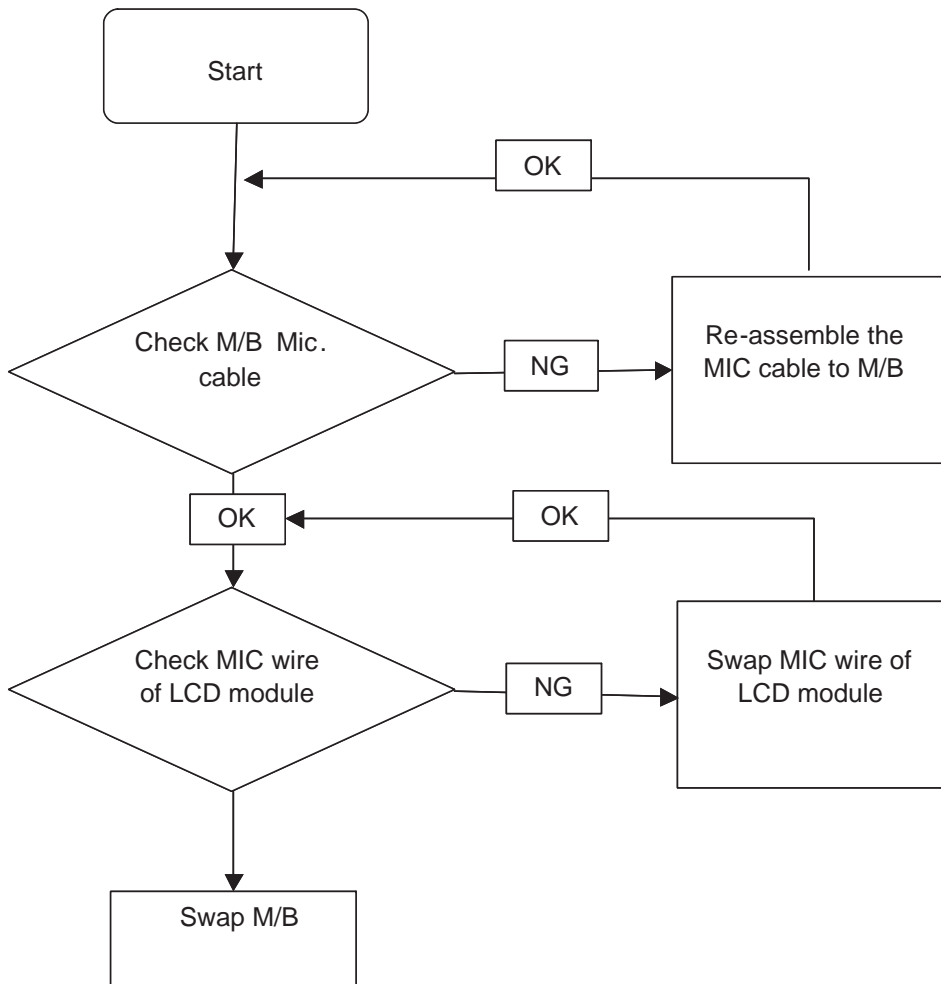

Microphone Problems

If internal or external **Microphones** do not operate correctly, perform the following actions one at a time to correct the problem.

1. Check that the microphone is enabled. Navigate to **Start** → **Control Panel** → **Hardware and Sound** → **Sound** and select the **Recording** tab.
2. Right-click on the **Recording** tab and select **Show Disabled Devices** (clear by default).
3. The microphone appears on the **Recording** tab.

-
4. Right-click on the microphone and select **Enable**.
 5. Select the microphone then click **Properties**. Select the **Levels** tab.
 6. Increase the volume to the maximum setting and click **OK**.
 7. Test the microphone hardware:
 - a. Select the microphone and click **Configure**.
 - b. Select **Set up microphone**.
 - c. Select the microphone type from the list and click **Next**.
 - d. Follow the onscreen prompts to complete the test.
 8. If the Issue is still not resolved, see "Online Support Information" on page 349.

HDD Not Operating Correctly

If the **HDD** does not operate correctly, perform the following actions one at a time to correct the problem.

1. Disconnect all external devices.
2. Run a complete virus scan using up-to-date software to ensure the computer is virus free.
3. Run the Windows 7 Startup Repair Utility:
 - a. insert the Windows 7 Operating System DVD in the ODD and restart the computer.
 - b. When prompted, press any key to start to the operating system DVD.
 - c. The **Install Windows** screen displays. Click **Next**.
 - d. Select **Repair your computer**.
 - e. The **System Recovery Options** screen displays. Click **Next**.
 - f. Select the appropriate operating system, and click **Next**.

NOTE: Click **Load Drivers** if controller drives are required.

 - g. Select **Startup Repair**.
 - h. Startup Repair attempts to locate and resolve issues with the computer.
 - i. When complete, click **Finish**.

If an issue is discovered, follow the onscreen information to resolve the problem.

4. Run the Windows Memory Diagnostic Tool. For more information see Windows Help and Support.
5. Restart the computer and press F2 to enter the BIOS Utility. Check the BIOS settings are correct and that CD/DVD drive is set as the first boot device on the Boot menu.
6. Ensure all cables and jumpers on the HDD and ODD are set correctly.
7. Remove any recently added hardware and associated software.
8. Run the Windows Disk Defragmenter. For more information see Windows Help and Support.
9. Run Windows Check Disk by entering **chkdsk /r** from a command prompt. For more information see Windows Help and Support.
10. Restore system and file settings from a known good date using **System Restore**.

If the issue is not fixed, repeat the preceding steps and select an earlier time and date.
11. Replace the HDD. See "Disassembly Process" on page 47.

USB Failure (Right up/down side)

If the rightside **USB** port fails, perform the following actions one at a time to correct the problem. Do not replace non-defective FRUs:

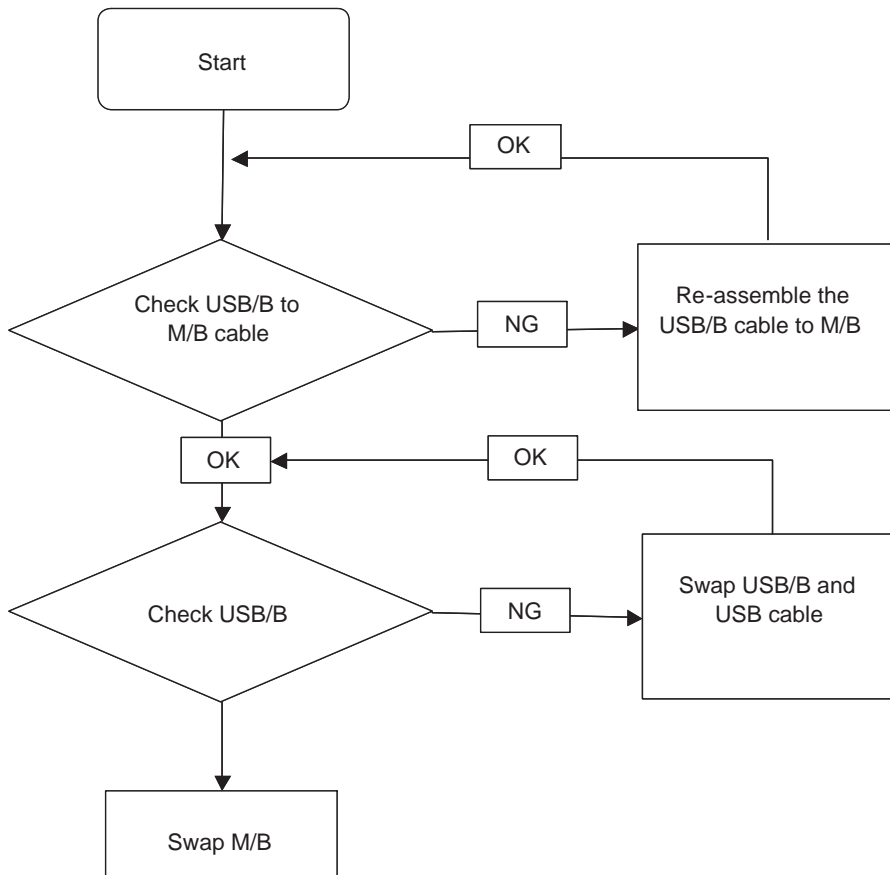

Other Failures

If the VGA board, LAN Port, external MIC or Speakers, PCI Express Card, 5-in-1 Card Reader or Volume Wheel fail, perform the following general steps to correct the problem. Do not replace non-defective FRUs:

1. Check whether the drive is OK.
2. Verify that the Test Fixture is OK.
3. Swap the mainboard and retest.

Intermittent Problems

Intermittent system hang problems can be caused by a variety of reasons that have nothing to do with a hardware defect, such as: cosmic radiation, electrostatic discharge, or software errors. FRU replacement should be considered only when a recurring problem exists.

When analyzing an intermittent problem, do the following:

1. Run the advanced diagnostic test for the system board in loop mode at least 10 times.
2. If no error is detected, do not replace any FRU.
3. If any error is detected, replace the FRU. Rerun the test to verify that there are no more errors.

Undetermined Problems

The diagnostic problems does not identify which adapter or device failed, which installed devices are incorrect, whether a short circuit is suspected, or whether the system is inoperative.

Follow these procedures to isolate the failing FRU (do not isolate non-defective FRU).

NOTE: Verify that all attached devices are supported by the computer.

NOTE: Verify that the power supply being used at the time of the failure is operating correctly. (See “Power On Issue” on page 172.):

1. Power-off the computer.
2. Visually check them for damage. If any problems are found, replace the FRU.
3. Remove or disconnect all of the following devices:
 - Non-Acer devices
 - Printer, mouse, and other external devices
 - Battery pack
 - Hard disk drive
 - DIMM
 - CD-ROM/Diskette drive Module
 - PC Cards
4. Power-on the computer.
5. Determine if the problem has changed.
6. If the problem does not recur, reconnect the removed devices one at a time until you find the failing FRU.
7. If the problem remains, replace the following FRU one at a time. Do not replace a non-defective FRU:
 - System board
 - LCD assembly

Post Code Reference Tables

These tables describe the POST codes and descriptions during the POST.

Post Code Range

Phase	POST Code Range
SEC	0x01 - 0x0F
PEI	0x70 - 0x9F
DXE	0x40 - 0x6F
BDS	0x10 - 0x3F
SMM	0xA0 - 0xBF
S3	0xC0 - 0xCF
ASL	0x51 – 0x55
	0xE1 – 0xE4
PostBDS	0xF9 – 0xFE
InsydeH2ODDT™ Reserve	0xD0 – 0xD7
OEM Reserve	0xE8 – 0xEB
Reserved	0xD8 – 0xE0
	0xE5 – 0xE7
	0xEC – 0xF8

SEC Phase POST Code Table

Functionality Name (Include\ PostCode.h)	Phase	Post Code	Description
SEC_SYSTEM_POWER_ON	SEC	1	CPU power on and switch to Protected mode
SEC_BEFORE_MICROCODE_PATCH	SEC	2	Patching CPU microcode
SEC_AFTER_MICROCODE_PATCH	SEC	3	Setup Cache as RAM
SEC_ACCESS_CSR	SEC	4	PCIE MMIO Base Address initial
SEC_GENERIC_MSRINIT	SEC	5	CPU Generic MSR initialization
SEC_CPU_SPEEDCFG	SEC	6	Setup CPU speed
SEC_SETUP_CAR_OK	SEC	7	Cache as RAM test
SEC_FORCE_MAX_RATIO	SEC	8	Tune CPU frequency ratio to maximum level
SEC_GO_TO_SECSTARTUP	SEC	9	Setup BIOS ROM cache
SEC_GO_TO_PEICORE	SEC	0A	Enter Boot Firmware Volume

PEI Phase POST Code Table:

Functionality Name (Include\ PostCode.h)	Phase	Post Code	Description
PEI_SIO_INIT	PEI	70	Super I/O Initialization
PEI_CPU_REG_INIT	PEI	71	CPU Early Initialization
PEI_PCIE_MMIO_INIT	PEI	74	PCIE MMIO BAR Initialization
PEI_NB_REG_INIT	PEI	75	North Bridge Early Initialization
PEI_SB_REG_INIT	PEI	76	South Bridge Early Initialization
PEI_TPM_INIT	PEI	78	TPM Initialization
PEI_SMBUS_INIT	PEI	79	SMBUS Early Initialization

Functionality Name (Include PostCode.h)	Phase	Post Code	Description
PEI_PROGRAM_CLOCK_GEN	PEI	7A	Clock Generator Initialization
PEI_IGD_EARLY_INITIAL	PEI	7B	Internal Graphic device early Initialization
PEI_HECI_INIT	PEI	7C	HECI Initialization
PEI_WATCHDOG_INIT	PEI	7D	Watchdog timer Initialization
PEI_MEMORY_INIT	PEI	7E	Memory Initial for Normal boot.
PEI_MEMORY_INIT_FOR_CRISIS	PEI	7F	Memory Initial for Crisis Recovery
PEI_MEMORY_INSTALL	PEI	80	Simple Memory test
PEI_TXTPEI	PEI	81	TXT function early Initialization
PEI_SWITCH_STACK	PEI	82	Start to use Memory
PEI_MEMORY_CALLBACK	PEI	83	Set cache for physical memory
PEI_ENTER_RECOVERY_MODE	PEI	84	Recovery device Initialization
PEI_RECOVERY_MEDIA_FOUND	PEI	85	Found Recovery image
PEI_RECOVERY_MEDIA_NOT_FOUND	PEI	86	Recovery image not found
PEI_RECOVERY_LOAD_FILE_DONE	PEI	87	Load Recovery Image completed
PEI_RECOVERY_START_FLASH	PEI	88	Start Flash BIOS with Recovery image
PEI_ENTER_DXEIPL	PEI	89	Loading BIOS image to RAM
PEI_FINDING_DXE_CORE	PEI	8A	Loading DXE core
PEI_GO_TO_DXE_CORE	PEI	8B	Enter DXE core

DXE Phase POST Code Table:

Functionality Name (Include PostCode.h)	Phase	PostCode	Description
DXE_TCGDXE	DXE	40	TPM initial in DXE
DXE_SB_SPI_INIT	DXE	41	South bridge SPI initialization
DXE_CF9_RESET	DXE	42	Setup Reset service
DXE_SB_SERIAL_GPIO_INIT	DXE	43	South bridge Serial GPIO initialization
DXE_SMMACCESS	DXE	44	Setup SMM ACCE SS service
DXE_SIO_INIT	DXE	46	Super I/O DXE initialization
DXE_LEGACY_REGION	DXE	47	Setup Legacy Region service
DXE_IDENTIFY_FLASH_DEVICE	DXE	49	Identify Flash device
DXE_FTW_INIT	DXE	4A	Fault Tolerant Write verification
DXE_VARIABLE_INIT	DXE	4B	Variable Service initialization
DXE_VARIABLE_INIT_FAIL	DXE	4C	Fail to initial Variable Service
DXE_MTC_INIT	DXE	4D	MTC Initial
DXE_CPU_INIT	DXE	4E	CPU Middle Initialization
DXE_MP_CPU_INIT	DXE	4F	Multi-processor MiddleInitialization
DXE_SMBUS_INIT	DXE	50	SMBUS Driver Initialization
DXE_SMART_TIMER_INIT	DXE	51	8259 Initialization
DXE_PCRTC_INIT	DXE	52	RTC Initialization
DXE_SATA_INIT	DXE	53	SATA Controller earlyInitialization

Functionality Name (Include PostCode.h)	Phase	PostCode	Description
DXE_SMM_CONTROLLER_INIT	DXE	54	Setup SMM Control service
DXE_LEGACY_INTERRUPT	DXE	55	Setup Legacy Interrupt service
DXE_RELOCATE_SMBASE	DXE	56	Relocate SMM BASE
DXE_FIRST_SMI	DXE	57	SMI test
DXE_VTD_INIT	DXE	58	VTD Initial
DXE_BEFORE_CSM16_INIT	DXE	59	Legacy BIOS Initialization
DXE_AFTER_CSM16_INIT	DXE	5A	Legacy interrupt function Initialization
DXE_LOAD_ACPI_TABLE	DXE	5B	ACPI Table Initialization
DXE_SB_DISPATCH	DXE	5C	Setup SB SMM Dispatcher service
DXE_SB_IOTRAP_INIT	DXE	5D	Setup SB IOTRAP Service
DXE_SUBCLASS_DRIVER	DXE	5E	Build AMT Table
DXE_PPM_INIT	DXE	5F	PPM Initialization
DXE_HECIDRV_INIT	DXE	60	HECIDRV Initialization

BDS Phase POST Code Table:

Functionality Name (Include PostCode.h)	Phase	Post Code	Description
BDS_ENTER_BDS	BDS	10	Enter BDS entry
BDS_INSTALL_HOTKEY	BDS	11	Install Hotkey service
BDS_ASF_INIT	BDS	12	ASF Initialization
BDS_PCI_ENUMERATION_START	BDS	13	PCI enumeration
BDS_BEFORE_PCIO_INSTALL	BDS	14	PCI resource assign complete
BDS_PCI_ENUMERATION_END	BDS	15	PCI enumeration complete
BDS_CONNECT_CONSOLE_IN	BDS	16	Keyboard Controller, Keyboard and Mouse initialization
BDS_CONNECT_CONSOLE_OUT	BDS	17	Video device initialization
BDS_CONNECT_STD_ERR	BDS	18	Error report device initialization
BDS_CONNECT_USB_HC	BDS	19	USB host controller initialization
BDS_CONNECT_USB_BUS	BDS	1A	USB BUS driver initialization
BDS_CONNECT_USB_DEVICE	BDS	1B	USB device driver initialization
BDS_NO_CONSOLE_ACTION	BDS	1C	Console device initial fail
BDS_DISPLAY_LOGO_SYSTEM_INFO	BDS	1D	Display logo or system information
BDS_START_IDE_CONTROLLER	BDS	1E	IDE controller initialization
BDS_START_SATA_CONTROLLER	BDS	1F	SATA controller initialization
BDS_START_ISA_ACPI_CONTROLLER	BDS	20	SIO controller initialization
BDS_START_ISA_BUS	BDS	21	ISA BUS driver initialization
BDS_START_ISA_FDD	BDS	22	Floppy device initialization
BDS_START_ISA_SEIRAL	BDS	23	Serial device initialization
BDS_START_IDE_BUS	BDS	24	IDE device initialization
BDS_START_AHCI_BUS	BDS	25	AHCI device initialization
BDS_CONNECT_LEGACY_ROM	BDS	26	Dispatch option ROMs
BDS_ENUMERATE_ALL_BOOT_OPTION	BDS	27	Get boot device information

Functionality Name (Include\ PostCode.h)	Phase	Post Code	Description
BDS_END_OF_BOOT_SELECTION	BDS	28	End of boot selection
BDS_ENTER_SETUP	BDS	29	Enter Setup Menu
BDS_ENTER_BOOT_MANAGER	BDS	2A	Enter Boot manager
BDS_BOOT_DEVICE_SELECT	BDS	2B	Try to boot system to OS
BDS_EFI64_SHADOW_ALL_LEGACY_ROM	BDS	2C	Shadow Misc Option ROM
BDS_ACPI_S3SAVE	BDS	2D	Save S3 resume required data in RAM
BDS_READY_TO_BOOT_EVENT	BDS	2E	Last Chipset initial before boot to OS
BDS_GO_LEGACY_BOOT	BDS	2F	Start to boot Legacy OS
BDS_GO_UEFI_BOOT	BDS	30	Start to boot UEFI OS
BDS_LEGACY16_PREPARE_TO_BOOT	BDS	31	Prepare to Boot to Legacy OS
BDS_EXIT_BOOT_SERVICES	BDS	32	Send END of POST Message to ME via HECI
BDS_LEGACY_BOOT_EVENT	BDS	33	Last Chipset initial before boot to Legacy OS.
BDS_ENTER_LEGACY_16_BOOT	BDS	34	Ready to Boot Legacy OS.
BDS_RECOVERY_START_FLASH	BDS	35	Fast Recovery Start Flash.

PostBDS POST Code Table

Functionality Name (Include\ PostCode.h)	Phase	Post Code	Description
POST_BDS_NO_BOOT_DEVICE	POST_BDS	F9	No Boot Device
POST_BDS_START_IMAGE	POST_BDS	FB	UEFI Boot Start Image
POST_BDS_ENTER_INT19	POST_BDS	FD	Legacy 16 boot entry
POST_BDS_JUMP_BOOT_SECTOR	POST_BDS	FE	Try to Boot with INT 19

S3 Functions POST Code Table

Functionality Name (Include\ PostCode.h)	Phase	Post Code	Description
POST_BDS_NO_BOOT_DEVICE	POST_BDS	F9	No Boot Device
POST_BDS_START_IMAGE	POST_BDS	FB	UEFI Boot Start Image
POST_BDS_ENTER_INT19	POST_BDS	FD	Legacy 16 boot entry
POST_BDS_JUMP_BOOT_SECTOR	POST_BDS	FE	Try to Boot with INT 19

ACPI Functions POST Code Table

Functionality Name (Include\ PostCode.h)	Phase	Post Code	Description
ASL_ENTER_S1	ASL	51	Prepare to enter S1
ASL_ENTER_S3	ASL	53	Prepare to enter S3
ASL_ENTER_S4	ASL	54	Prepare to enter S4
ASL_ENTER_S5	ASL	55	Prepare to enter S5
ASL_WAKEUP_S1	ASL	E1	System wakeup from S1
ASL_WAKEUP_S3	ASL	E3	System wakeup from S3
ASL_WAKEUP_S4	ASL	E4	System wakeup from S4

SMM Functions POST Code Table

Functionality Name (Include\ PostCode.h)	Phase	Post Code	Description
SMM_IDENTIFY_FLASH_DEVICE	SMM	0xA0	Identify Flash device in SMM
SMM_SMM_PLATFORM_INIT	SMM	0xA2	SMM service initial
SMM_ACPI_ENABLE_START	SMM	0xA6	OS call ACPI enable function
SMM_ACPI_ENABLE_END	SMM	0xA7	ACPI enable function complete
SMM_S1_SLEEP_CALLBACK	SMM	0xA1	Enter S1
SMM_S3_SLEEP_CALLBACK	SMM	0xA3	Enter S3
SMM_S4_SLEEP_CALLBACK	SMM	0xA4	Enter S4
SMM_S5_SLEEP_CALLBACK	SMM	0xA5	Enter S5
SMM_ACPI_DISABLE_START	SMM	0xA8	OS call ACPI disable function
SMM_ACPI_DISABLE_END	SMM	0xA9	ACPI disable function complete

InsydeH2ODDT Debugger POST Code Table

Functionality Name (Include\ PostCode.h)	PostCode	Description
Used by Insyde debugger	0x0D	Waiting for device connect
Used by Insyde debugger	0xD0	Waiting for device connect
Used by Insyde debugger	0xD1	InsydeH2ODDT Ready
Used by Insyde debugger	0xD2	EHCI not found
Used by Insyde debugger	0xD3	Debug port connect low speed device
Used by Insyde debugger	0xD4	DDT Cable become low speed device
Used by Insyde debugger	0xD5	DDT Cable Transmission Error (Get descriptor fail)
Used by Insyde debugger	0xD6	DDT Cable Transmission Error (Set Debug mode fail)
Used by Insyde debugger	0xD7	DDT Cable Transmission Error (Set address fail)

Jumper and Connector Locations

Mainboard Top View

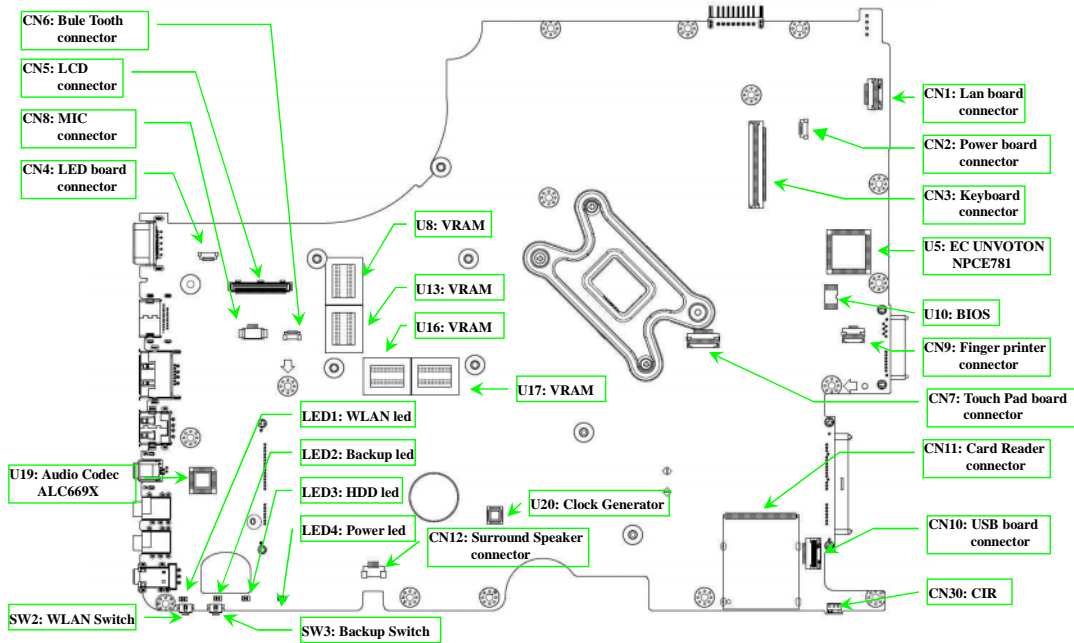

Item	Description	Item	Description
CN4	LED board connector	CN7	Touchpad connector
CN8	Microphone connector	CN11	Card reader connector
CN5	LCD connector	CN10	USB board connector
CN6	Bluetooth connector	CN30	CIR
U8	VRAM	U20	Clock Generator
U13	VRAM	CN12	Surround speaker connector
U16	VRAM	SW3	Backup switch
U17	VRAM	SW2	WLAN switch
CN1	LAN board connector	U19	Audio Codec ALC669X
CN2	Power board connector	LED1	WLAN LED
CN3	Keyboard connector	LED2	Back up LED
U5	EC UNVOTON NPCE781	LED3	HDD LED
U10	BIOS	LED4	Power LED
CN9	Fingerprinter connector		

Mainboard Bottom View

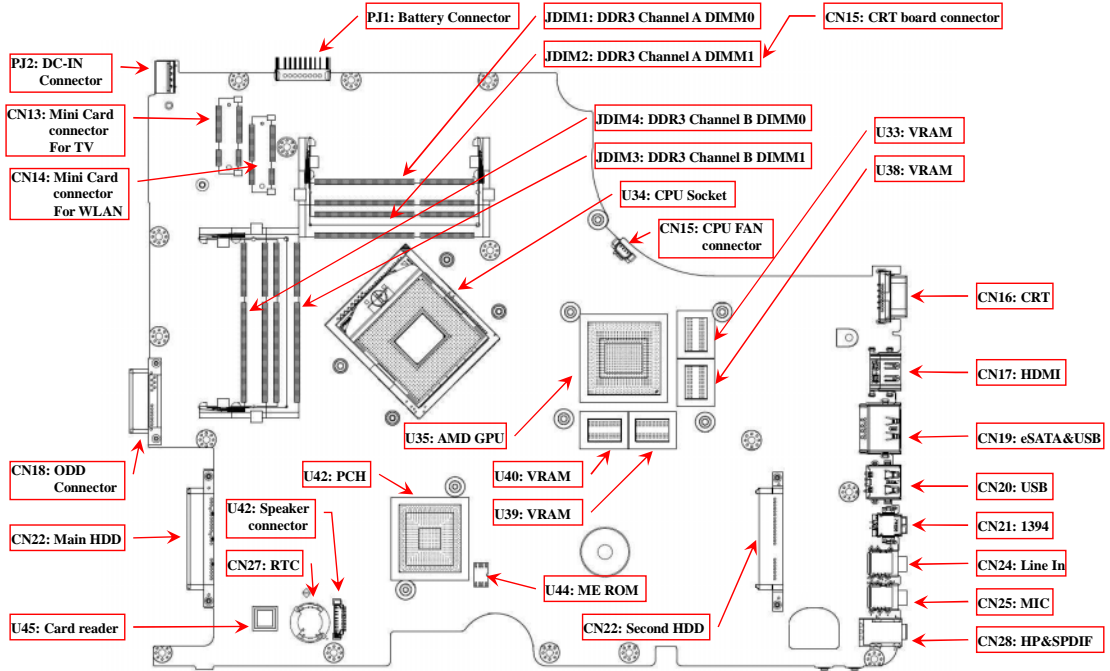

Item	Description	Item	Description
CN14	Minicard connector for WLAN	CN20	USB
CN13	Minicard connector for TV	CN21	1394
PJ2	DC-IN connector	CN24	Line in
PJ1	Battery connector	CN25	Microphone
JDIM1	DDR3 Channel A DIMM0	CN28	HP & SPDIF
JDIM2	DR3 Channel A DIMM1	CN22	Second HDD
JDIM4	DDR3 Channel B DIMM0	U44	ME ROM
JDIM3	DDR3 Channel B DIMM1	U39	VRAM
CN15	CRT board connector	U40	VRAM
U34	CPU socket	U35	AMD GPU
CN15	CPU fan connector	U42	PCH
U33	VRAM	U42	Speaker connector
U38	VRAM	CN27	RTC
CN16	CRT	U45	Card reader
CN17	HDMI	CN22	Main HDD
CN19	eSATA&USB	CN18	ODD connector

Clearing Password Check and BIOS Recovery

This section provides a procedure for clearing the password and BIOS. The Hardware Open Gap on the main board clears the CMOS of all user settings and restores factory defaults.

Mainboard CMOS Discharge

Discharging the CMOS clears all user settings.

1. Disassemble the notebook and take out the Mainboard. See “Removing the Mainboard” on page 84.
2. Remove the RTC battery. See “Removing the RTC Battery” on page 86.

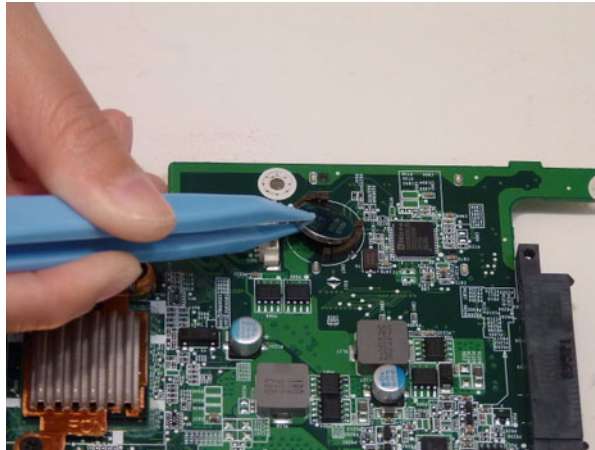

3. Turn the mainboard over and short the G2 pad.

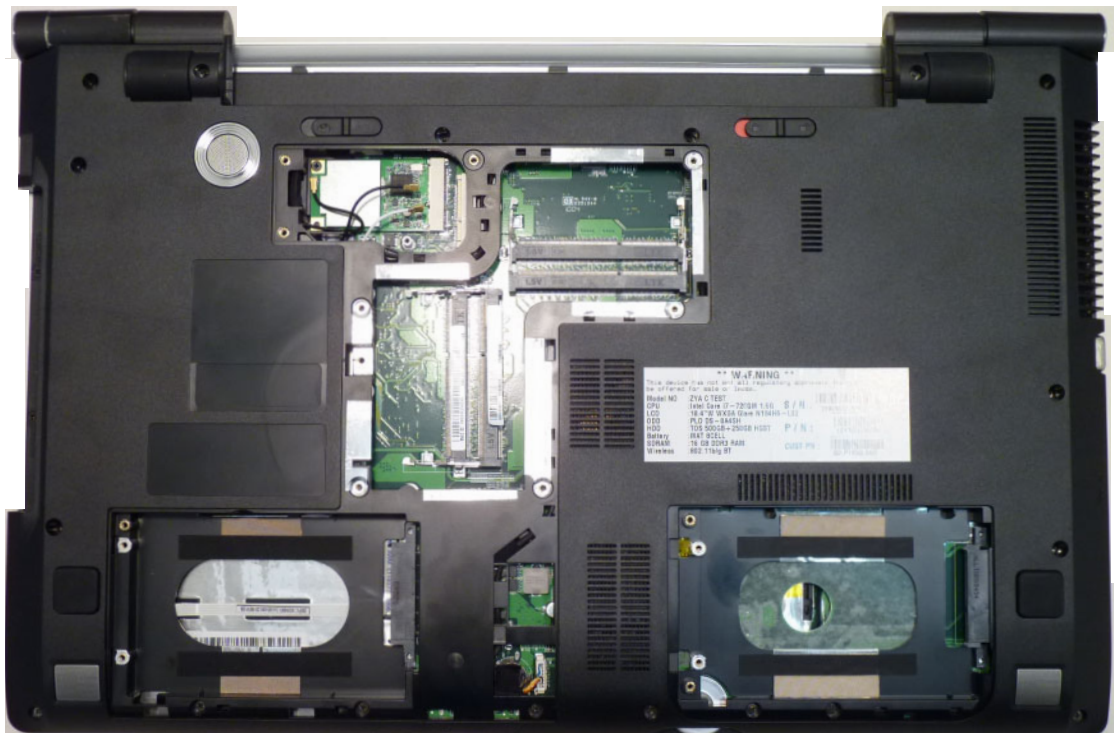

4. Reconnect the RTC battery and reassemble the unit.

BIOS Recovery by Crisis Disk

BIOS Recovery Boot Block

The BIOS Recovery Boot Block is a special block of BIOS. It is used to boot up the system with minimum BIOS initialization. Users can enable this feature to restore the BIOS firmware to the factory settings if a BIOS flash process fails.

BIOS Recovery Hotkey

The system provides a function hotkey: **Fn+Esc**, to enable the BIOS Recovery process when a system is powered on during BIOS POST. To use this function, it is strongly recommended to have the AC adapter and Battery present. If this function is enabled, the system will force the BIOS to enter a special BIOS block, called Boot Block.

Steps for BIOS Recovery from USB Storage

Before performing this procedure, prepare a Crisis USB key. The Crisis USB key can be made by executing the Crisis Disk program in a functioning system with a Windows 7 OS.

IMPORTANT:The Crisis Disk program will overwrite all data on any drive that you use as a crisis disk.

Follow the steps below:

1. Plug the USB storage into a USB port.
2. Press **Fn + ESC** button then plug in AC.
The Power button flashes once.
3. Press **Power** button to initiate system CRISIS mode.
When CRISIS is complete, the system auto restarts with a workable BIOS.
4. Update the latest version BIOS for this machine by the regular BIOS flashing process.

FRU (Field Replaceable Unit) List

This chapter gives you the FRU (Field Replaceable Unit) listing in global configurations of the computer. Refer to this chapter whenever ordering for parts to repair or for RMA (Return Merchandise Authorization).

Please note that WHEN ORDERING FRU PARTS, you should check the most up-to-date information available on your regional web or channel. For whatever reasons a part number change is made, it will not be noted on the printed Service Guide. For ACER AUTHORIZED SERVICE PROVIDERS, your Acer office may have a DIFFERENT part number code from those given in the FRU list of this printed Service Guide. You MUST use the local FRU list provided by your regional Acer office to order FRU parts for repair and service of customer machines.

NOTE: To scrap or to return the defective parts, you should follow the local government ordinance or regulations on how to dispose it properly, or follow the rules set by your regional Acer office on how to return it.

Exploded Diagrams

Main Assembly

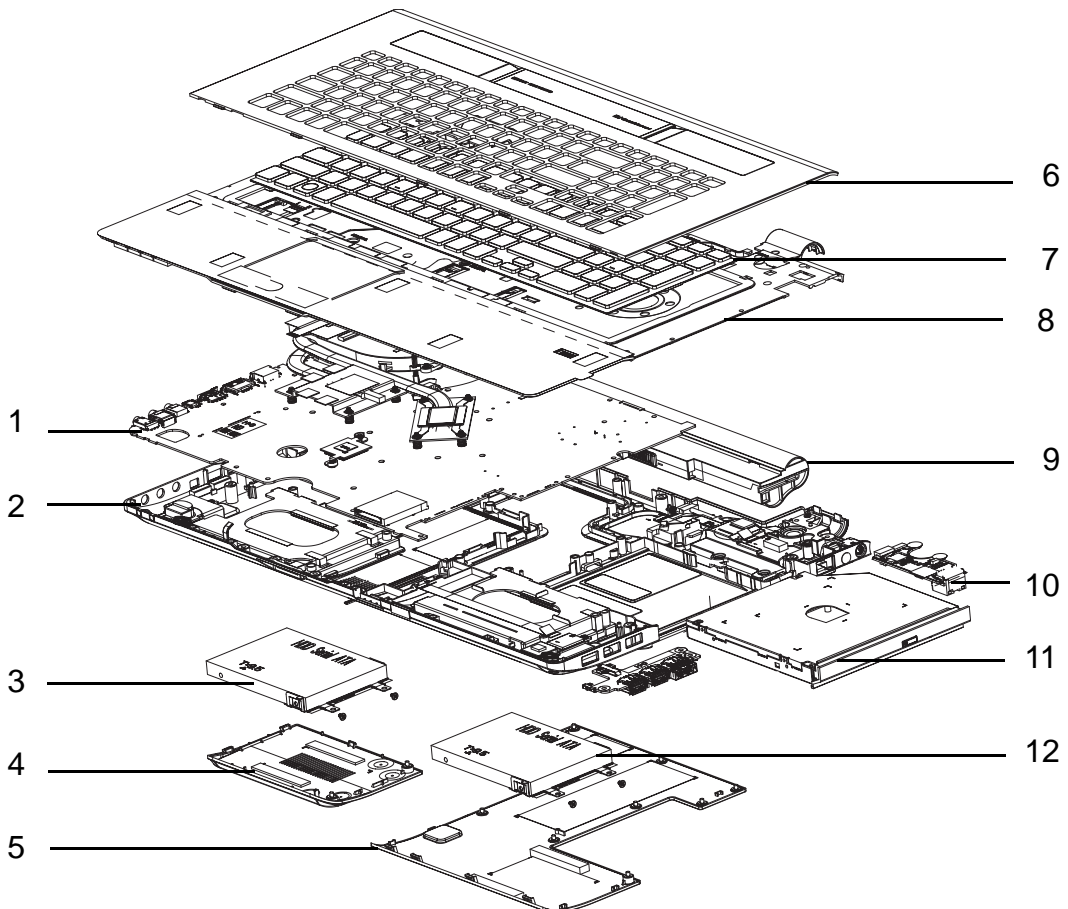

Item	Description	Part Number
1	Mainboard	MB.PWC06.001
2	Lower Cover	60.PTK07.001
3	2nd HDD	KH.32001.017





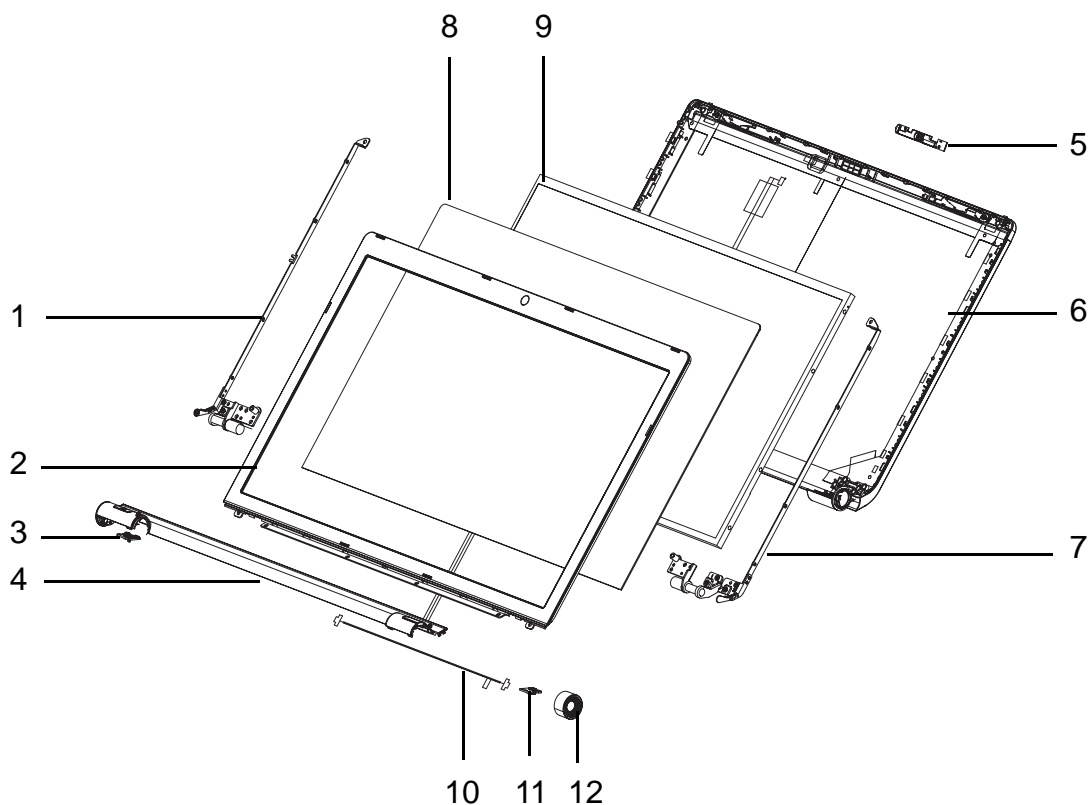

Item	Description	Part Number
4	2nd HDD Cover	42.PWC07.001
5	Logic Lower Cover	42.PWC07.002
6	Keyboard Frame	60.PWC07.001
7	Keyboard	KB.I170A.179
8	Upper Cover	60.PWC07.002
9	Battery	BT.00805.015
10	LAN Board	55.PWC07.005
11	ODD	6M.PWC07.006
12	HDD	KH.32001.017



LCD Assembly





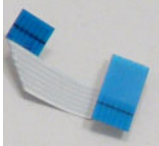

Item	Description	Part Number	Item	Description	Part Number
1	Glass Hinge (L)	33.PWC07.004	7	Glass Hinge (R)	33.PWC07.005
2	LCD Bezel	60.PWC07.005	8	Glass	
3	LED Board Assy	55.PWC07.007	9	LCD Panel	6M.PU207.001
4	LCD Bezel Cap Sub Assy	60.PWC07.006	10	Microphone Cable	
5	Web Camera Board	AM.21400.068	11	Power Board Assy	55.PWC07.006
6	LCD Cover	60.PWC07.004	12	Hinge Cap (R)	

FRU List

CATEGORY	Acer Description	AcerPN
ADAPTER		
	ADAPTER LITE-ON 90W 19V 1.7X5.5X11 BLUE PA-1900-34AR, LV5 LED LF	AP.09003.021
	ADAPTER DELTA 90W 19V 1.7X5.5X11 BLUE ADP-90CD DB A, LV5 LED LF	AP.09001.027
	ADAPTER HIPRO 90W 19V 1.7X5.5X11 BLUE HP-A0904A3 B1LF, LV5 LED LF	AP.0900A.005
BATTERY		
	BATTERY SIMPLO AS10C LI-ION 4S2P SAMSUNG 8 CELL 6000MAH MAIN COMMON ID:AS10C7E	BT.00807.028
	BATTERY PANASONIC AS10C LI-ION 4S2P PANASONIC 8 CELL 6000MAH MAIN COMMON ID:AS10C5E	BT.00805.015
BOARD		
	FOXCONN BLUETOOTH BRM 2046 BT2.1 (T60H928.33) F/W:861	BH.21100.004
	FOXCONN BLUETOOTH ATH AR3011	BH.21100.005
	USB BOARD W/FFC	55.PWL02.001
	POWER BOARD W/CABLE	55.PWL02.002
	ARCADE BOARD W/LCD CABLE	55.PWL02.003
	FINGER PRINT BOARD W/ FFC	55.PWL02.004
	TP BOARD W/FFC	55.PWL02.005

CATEGORY	Acer Description	AcerPN
	DVB-T Mini-card TT-1281DA w/DiBCOM DIB7770	TU.23100.023
	FOXCONN WIRELESS LAN Atheros HB93 2X2 BGN (HM)	NI.23600.062
	FOXCONN WIRELESS LAN BROADCOMM 43225 2X2 BGN (HM) T77H103.00	NI.23600.066
	FOXCONN WIRELESS LAN Atheros HB95BG (HM) T77H121.10	NI.23600.077
	FOXCONN WIRELESS LAN Atheros HB97 2X2 BGN (HM)	NI.23600.072
	LITEON WIRELESS LAN Atheros HB97 2X2 BGN (HM) WN6603AH	NI.23600.073
CABLE		
	BLUE TOOTH CABLE-8PIN	50.PWL02.001
	BLUE TOOTH CABLE-6PIN	50.PWL02.002
	TP FFC	50.PWL02.003
	RF IN CABLE	50.PWL02.004
	TV TUNER ANTENNA	50.PWL02.005
	SMB-PAL JACK	20.PWL02.001
	PAL-F JACK	20.PWL02.002





CATEGORY	Acer Description	AcerPN
	POWER CORD US 3 PIN	27.TAVV5.001
	POWER CORD EU 3 PIN	27.TAVV5.002
	POWER CORD AUS 3 PIN	27.TAVV5.003
	POWER CORD UK 3 PIN	27.TAVV5.004
	POWER CORD CHINA 3 PIN	27.TAVV5.005
	POWER CORD SWISS 3 PIN	27.TAVV5.006
	POWER CORD ITALIAN 3 PIN	27.TAVV5.007
	POWER CORD DENMARK 3 PIN	27.TAVV5.008
	POWER CORD JP 3 PIN	27.TAVV5.009
	POWER CORD SOUTH AFRICA 3 PIN	27.TAVV5.010
	POWER CORD KOREA 3 PIN	27.TAVV5.011
	POWER CORD ISRAEL 3 PIN	27.TAVV5.012
	POWER CORD INDIA 3 PIN	27.TAVV5.013
	POWER CORD TWN 3 PIN	27.TAVV5.014
	POWER CORD ARGENTINA 3 PIN	27.APV02.001
	POWER CORD BRAZIL 3 PIN	27.SAD02.001
CASE/COVER/BRACKET ASSEMBLY		
	UPPER CASE ASSY-103 Key	60.PWL02.001
	UPPER CASE ASSY-104 Key	60.PWL02.002
	LOWER CASE FOR W/O RF	60.PWL02.003
	LOWER CASE FOR W/RF	60.PWL02.004
	UPPER PALM REST	60.PWL02.005
	KB PLATE	33.PWL02.001
	TP COVER, INCL. TP	55.PWL02.006
	HDD_MINI DOOR W/ SCREW*5	42.PWL02.001







CATEGORY	Acer Description	AcerPN
	HDD BRACKET	33.PWL02.002
	FINGER PRINT BRACKET	33.PWL02.003
CPU/PROCESSOR		
	CPU INTEL CORE I3 330M PGA 2.13G 35W ARRANDALE, TJ90, VT, 3M L3	KC.33001.DMP
	CPU INTEL CORE I3 350M PGA 2.26G 35W ARRANDALE, TJ90, VT, 3M L3	KC.35001.DMP
	CPU INTEL CORE I5 430M PGA 2.26G ARD, UP TO SC 2.53G, 3M L3	KC.43001.DMP
	CPU INTEL CORE I5 520M 2.4G 3M	KC.52001.DMP
	CPU INTEL CORE I5 540M 2.53G 3M	KC.54001.DMP
	CPU INTEL CORE I7 620M PGA 2.66G	KC.62001.DMP
	CPU INTEL CORE I7 720QM 1.6G 6M 1333 45W	KC.72001.QMP

CATEGORY	Acer Description	AcerPN
HDD		
	HDD TOSHIBA 2.5" 5400RPM 250GB MK2565GSX, CAPRICORN BS, 320G/P SATA 8MB LF F/W:GJ002J	KH.25004.005
	HDD SEAGATE 2.5" 5400RPM 320GB ST9320325AS WYATT SATA LF F/W:0001SDM1	KH.32001.017
	HDD TOSHIBA 2.5" 5400RPM 320GB CAPRICORN BS ,MK3265GSX SATA 8MB LF F/W:GJ002J	KH.32004.004
	HDD HGST 2.5" 5400RPM 320GB HTS545032B9A300 PANTHER B SATA LF F/ W:C60F DISK IMBALANCE CRITERIA = 0.014G-CM	KH.32007.008
	HDD WD 2.5" 5400RPM 320GB WD3200BEVT- 22A23T0,ML320S,WD SATA 8MB LF F/ W:01.01A01	KH.32008.019
	HDD SEAGATE 2.5" 5400RPM 500GB ST9500325AS WYATT SATA LF F/W:0001SDM1	KH.50001.011
	HDD HGST 2.5" 5400RPM 500GB HTS545050B9A300 PANTHER B SATA LF F/ W:C60F DISK IMBALANCE CRITERIA = 0.014G-CM	KH.50007.010
	HDD WD 2.5" 5400rpm 500GB WD5000BEVT- 22A0RT0, ML320M,WD SATA 8MB LF F/ W:01.01A01	KH.50008.017
	HDD WD 2.5" 5400RPM 640GB WD6400BEVT- 22A0RT0, ML320 SATA 8MB LF F/W:01.01A01	KH.64008.004

CATEGORY	Acer Description	AcerPN
KEYBOARD		
	Keyboard ACER AF7P_A10S AF7P Internal 17 Standard 103KS Silver US International Painting	KB.I170A.200
	Keyboard ACER AF7P_A10S AF7P Internal 17 Standard 103KS Silver Greek Painting	KB.I170A.184
	Keyboard ACER AF7P_A10S AF7P Internal 17 Standard 103KS Silver Arabic Painting	KB.I170A.175
	Keyboard ACER AF7P_A10S AF7P Internal 17 Standard 103KS Silver Chinese Painting	KB.I170A.179
	Keyboard ACER AF7P_A10S AF7P Internal 17 Standard 103KS Silver Russian Painting	KB.I170A.192
	Keyboard ACER AF7P_A10S AF7P Internal 17 Standard 103KS Silver US International w/ Hebrew Painting	KB.I170A.201
	Keyboard ACER AF7P_A10S AF7P Internal 17 Standard 103KS Silver Thailand Painting	KB.I170A.197
	Keyboard ACER AF7P_A10S AF7P Internal 17 Standard 103KS Silver Korean Painting	KB.I170A.188
	Keyboard ACER AF7P_A10S AF7P Internal 17 Standard 104KS Silver UK Painting	KB.I170A.199
	Keyboard ACER AF7P_A10S AF7P Internal 17 Standard 104KS Silver German Painting	KB.I170A.183
	Keyboard ACER AF7P_A10S AF7P Internal 17 Standard 104KS Silver Swiss/G Painting	KB.I170A.196
	Keyboard ACER AF7P_A10S AF7P Internal 17 Standard 104KS Silver Belgium Painting	KB.I170A.176
	Keyboard ACER AF7P_A10S AF7P Internal 17 Standard 104KS Silver Danish Painting	KB.I170A.180



CATEGORY	Acer Description	AcerPN
	Keyboard ACER AF7P_A10S AF7P Internal 17 Standard 104KS Silver Italian Painting	KB.I170A.186
	Keyboard ACER AF7P_A10S AF7P Internal 17 Standard 104KS Silver French Painting	KB.I170A.182
	Keyboard ACER AF7P_A10S AF7P Internal 17 Standard 104KS Silver Hungarian Painting	KB.I170A.185
	Keyboard ACER AF7P_A10S AF7P Internal 17 Standard 104KS Silver Norwegian Painting	KB.I170A.190
	Keyboard ACER AF7P_A10S AF7P Internal 17 Standard 104KS Silver Portuguese Painting	KB.I170A.191
	Keyboard ACER AF7P_A10S AF7P Internal 17 Standard 104KS Silver Spanish Painting	KB.I170A.194
	Keyboard ACER AF7P_A10S AF7P Internal 17 Standard 104KS Silver US w/ Canadian French Painting	KB.I170A.202
	Keyboard ACER AF7P_A10S AF7P Internal 17 Standard 104KS Silver Turkish Painting	KB.I170A.198
	Keyboard ACER AF7P_A10S AF7P Internal 17 Standard 104KS Silver Sweden Painting	KB.I170A.195
	Keyboard ACER AF7P_A10S AF7P Internal 17 Standard 104KS Silver FR/Arabic Painting	KB.I170A.181
	Keyboard ACER AF7P_A10S AF7P Internal 17 Standard 104KS Silver Nordic Painting	KB.I170A.189
	Keyboard ACER AF7P_A10S AF7P Internal 17 Standard 104KS Silver SLO/CRO Painting	KB.I170A.193
	Keyboard ACER AF7P_A10S AF7P Internal 17 Standard 104KS Silver CZ/SK Painting	KB.I170A.178



CATEGORY	Acer Description	AcerPN
	Keyboard ACER AF7P_A10S AF7P Internal 17 Standard 104KS Silver Brazilian Portuguese Painting	KB.I170A.177
	Keyboard ACER AF7P_A10S AF7P Internal 17 Standard 107KS Silver Japanese Painting	KB.I170A.187
DVD RW DRIVE		
	ODD SUPER-MULTI DRIVE MODULE	6M.PWL02.001
	ODD TOSHIBA SUPER- MULTI DRIVE 12.7MM TRAY DL 8X TS-L633C LF W/O BEZEL SATA (HF + WINDOWS 7)	KU.00801.035
	ODD HLDS SUPER-MULTI DRIVE 12.7MM TRAY DL 8X GT30N LF W/O BEZEL SATA (HF + WINDOWS 7)	KU.0080D.048
	ODD PANASONIC SUPER- MULTI DRIVE 12.7MM TRAY DL 8X UJ890A LF W/ O BEZEL SATA (HF + WINDOWS 7)	KU.00807.070
	ODD SONY SUPER-MULTI DRIVE 12.7MM TRAY DL 8X AD-7585H LF W/O BEZEL SATA (HF + WINDOWS 7)	KU.0080E.027
	ODD PLDS SUPER-MULTI DRIVE 12.7MM TRAY DL 8X DS-8A4SH LF W/O BEZEL SATA (HF + WINDOWS 7)	KU.0080F.006
	ODD HLDS SUPER-MULTI DRIVE 12.7MM TRAY DL 8X GT31N (R5-1) LF W/O BEZEL SATA WITH RENESAS SOLUTION (HF + WINDOWS 7)	KU.0080D.054
	ODD BEZEL-SM	42.PWL02.002
	ODD BRACKET	33.PWL02.005

CATEGORY	Acer Description	AcerPN
BD COMBO DRIVE		
	ODD BD COMBO MODULE	6M.PWL02.002
	ODD PLDS BD COMBO 12.7MM TRAY DL 4X DS-4E1S LF W/O BEZEL SATA (WINDOWS 7)	KO.0040F.003
	ODD HLDS BD COMBO 12.7MM TRAY DL 4X CT21N LF W/O BEZEL 1.00 SATA (HF + WINDOWS 7)	KO.0040D.004
	ODD SONY BD COMBO 12.7MM TRAY DL 4X BC-5500H LF W/O BEZEL SATA (HF + WINDOWS 7)	KO.0040E.003
	ODD BEZEL-BD	42.PWL02.003
	ODD BRACKET	33.PWL02.005
BD RW DRIVE		
	ODD BD RW MODULE	6M.PWL02.003
	ODD PANASONIC BD RW 12.7MM TRAY DL 4X UJ240A LF W/O BEZEL SATA (HF+WINDOWS 7)	KU.00407.015
	ODD BEZEL-BD	42.PWL02.003
	ODD BRACKET	33.PWL02.005
LCD ASSEMBLY		
	ASSY LED MODULE 15.6"W WXGA GLARE SLIM w/ ANTENNA*2, CCD 1.3M, FLUSH PANEL	6M.PWL02.004
LCD		

CATEGORY	Acer Description	AcerPN
	ASSY LED MODULE 15.6"W WXGA GLARE SLIM w/ ANTENNA*2, CCD 1.3M	6M.PWG02.001
	LCD COVER	60.PWL02.006
	ANTENNA WLAN-MAIN	50.PWL02.006
	ANTENNA WLAN-AUX	50.PWL02.007
	LCD BEZEL-PLASTIC	60.PWL02.007
	LCD BEZEL CASE	60.PWL02.008
	LCD HINGE BRACKET R+L	33.PWL02.004
	CAMERA 1.3M	57.PWL02.001
	LED LCD AUO 15.6"W WXGA GLARE B156XW04 V0 LF 200NIT 8MS 400:1 (POWER SAVING)	LK.15605.015

CATEGORY	Acer Description	AcerPN
MAINBOARD		
	MAINBOARD AS5943G INTEL HM55 LF Q CORE_MADISONPRO+TV	MB.PWH02.002
	MAINBOARD AS5943G INTEL HM55 LF Q CORE BROADWAYPRO+TV	MB.PWN02.002
	MAINBOARD AS5943G INTEL HM55 LF MADISON_PRO 1GB QUAL CORE	MB.PWH02.001
	MAINBOARD AS5943G INTEL HM55 LF BROADWAY_PRO 1GB QUAL CORE	MB.PWN02.001
	MAINBOARD AS5943G INTEL HM55 LF D CORE_MADISONPRO+TV	MB.PVQ02.002
	MAINBOARD AS5943G INTEL HM55 LF D CORE_BROADWAYPRO+ TV	MB.PWL02.002
	MAINBOARD AS5943G INTEL HM55 LF MADISON_PRO 1GB DUAL CORE	MB.PVQ02.001
	MAINBOARD AS5943G INTEL HM55 LF BROADWAY_PRO 1GB DUAL CORE	MB.PWL02.001

CATEGORY	Acer Description	AcerPN
MEMORY		
	MEMORY HYNIX SO-DIMM DDRIII 1066 1GB HMT112S6BFR6C-G7 N0 LF 64*16 0.055UM	KN.1GB0G.025
	MEMORY SAMSUNG SO-DIMM DDRIII 1066 1GB M471B2873EH1-CF8 LF 64*16 0.055UM	KN.1GB0B.028
	MEMORY ELPIDA SO-DIMM DDRIII 1066 1GB EBJ10UE8BDS0-AE-F LF 128*8 0.065UM	KN.1GB09.012
	MEMORY MICRON SO-DIMM DDRIII 1066 2GB MT16JSF25664HZ-1G1F1 LF 128*8 0.065UM	KN.2GB04.015
	MEMORY SAMSUNG SO-DIMM DDRIII 1066 2GB M471B5673EH1-CF8 LF 128*8 0.055UM	KN.2GB0B.012
	MEMORY ELPIDA SO-DIMM DDRIII 1066 2GB EBJ21UE8BDS0-AE-F LF 128*8 0.065UM	KN.2GB09.006
	MEMORY SAMSUNG SO-DIMM DDRIII 1333 1GB M471B2873FHS-CH9 LF 128*8 46NM	KN.1GB0B.035
	MEMORY SAMSUNG SO-DIMM DDRIII 1333 2GB M471B5673FH0-CH9 LF 128*8 46NM	KN.2GB0B.023
	MEMORY ELPIDA SO-DIMM DDRIII 1333 4GB EBJ41UF8BAS0-DJ-F LF 256*8 0.055UM	KN.4GB09.001
	MEMORY SAMSUNG SO-DIMM DDRIII 1333 4GB M471B5273CH0-CH9 LF 256*8 46NM	KN.4GB0B.010
HEATSINK		
	THERMAL MODULE - CLARKSFIELD (DIS)	60.PWM02.001
	THERMAL MODULE - ARRANDALE (SWITCHABLE)	60.PWL02.009
SPEAKER		
SPEAKER	MIC	23.PWL02.001

CATEGORY	Acer Description	AcerPN
	SPEAKER L+R	23.PWL02.002
	SUBWOOFER	23.PWL02.003
ACCESSORY		
	Formosa21 Remote Controller RC804V-B EN	RT.22700.011
	Fomosa21 Remote Controller RC804V-B EU	RT.22700.008
	Formosa21 Remote Controller RC804V-B TC	RT.22700.009
	Formosa21 Remote Controller RC804V-B SC	RT.22700.010

Screw Table

CATEGORY	Acer Description	P/N
SCREW		
	SCREW 2.5D 3.0L K 5.3D NI NL	86.PWL02.001
	SCREW 1.98D 3.0L K 4.6D 0.8T ZK NL	86.PWL02.002
	SCREW 2.5D 5.7+2L K 6.0D ZK NL CR3	86.PWL02.003
	SCREW 1.6D 2.5L K 3.0D NI NL 0.3T	86.PWL02.004
	THML SPRING SCREW ASSY	86.PWL02.005
	SCREW 2.5D 5L K 5.5D ZK NL CR3	86.PWL02.006
	SCREW 2.5D 9.8+2.8L K 8D ZK NL	86.PWL02.007
	SCREW 2.45D 8.0L K 5.5D 0.8T ZK NL	86.PWL02.008
	SCREW 3.0D 3.0L K 4.9D NI	86.PWL02.009
	SCREW 2.5D 3.4+2.6L K 4.5D ZK CR3	86.PWL02.010

Model Definition and Configuration

Aspire 8943G

Model	Acer P/N	RO	Country	Description
AS8943G-724G64Mn	LX.PUH 02.009	EMEA	Austria	AS8943G-724G64Mn W7HP64ATAT1 MC BROADWAY_PRO1GBCFPssQ_3D4V3J 2*2G/640/BT/8L3.0/5R/CBUL_bgn_FP_1.3C_AL_DE61
AS8943G-728G64Bi	LX.PUH 02.090	EMEA	Russia	AS8943G-728G64Bi W7HP64RUATRU1 MC BROADWAY_PRO1GBCFPssQ_3D4V3J 2G+2G+2G+2G/640/BT/8L3.0/5R/CBUL_bg_FP_1.3C_AL_R_RU11
AS8943G-728G1.28TWn	LX.PUH 02.253	AAP	Thailand	AS8943G-728G1.28TWn EM W7HP64EMATTH1 MC BROADWAY_PRO1GBCFPssQ_3D4V3J 2G+2G+2G+2G/640+640/BT/8L3.0/5R/CBUL_bgn_FP_1.3C_AL_TH41
AS8943G-728G1.28TWn	LX.PUH 02.252	AAP	Thailand	AS8943G-728G1.28TWn EM W7HP64EMATTH1 MC BROADWAY_PRO1GBCFPssQ_3D4V3J 2*4G/640+640/BT/8L3.0/5R/CBUL_bgn_FP_1.3C_AL_TH41
AS8943G-728G1.28TBn	LX.PUH 02.161	EMEA	Belgium	AS8943G-728G1.28TBn W7HP64ATBE1 MC BROADWAY_PRO1GBCFPssQ_3D4V3J 2G+2G+2G+2G/640+640/BT/8L3.0/5R/CBUL_bgn_FP_1.3C_AL_NL11
AS8943G-728G1TBn	LX.PUH 02.186	EMEA	Switzerland	AS8943G-728G1TBn W7HP64ATCH1 MC BROADWAY_PRO1GBCFPssQ_3D4V3J 2G+2G+2G+2G/500_L+500_L/BT/8L3.0/5R/CBUL_bgn_FP_1.3C_AL_R_IT41
AS8943G-728G64Bn	LX.PUH 02.066	EMEA	Eastern Europe	AS8943G-728G64Bn W7HP64ATEU5 MC BROADWAY_PRO1GBCFPssQ_3D4V3J 2G+2G+2G+2G/640/BT/8L3.0/5R/CBUL_bgn_FP_1.3C_AL_R_RO11
AS8943G-724G1TBn	LX.PUH 02.249	EMEA	Belgium	AS8943G-724G1TBn W7HP64ATBE1 MC BROADWAY_PRO1GBCFPssQ_3D4V3J 2*2G/500_L+500_L/BT/8L3.0/5R/CBUL_bgn_FP_1.3C_AL_NL11
AS8943G-724G1TBn	LX.PUH 02.248	EMEA	Holland	AS8943G-724G1TBn W7HP64ATNL1 MC BROADWAY_PRO1GBCFPssQ_3D4V3J 2*2G/500_L+500_L/BT/8L3.0/5R/CBUL_bgn_FP_1.3C_AL_NL11
AS8943G-728G1TBn	LX.PUH 02.129	EMEA	Middle East	AS8943G-728G1TBn EM W7HP64EMATME9 MC BROADWAY_PRO1GBCFPssQ_3D4V3J 2G+2G+2G+2G/500_L+500_L/BT/8L3.0/5R/CBUL_bgn_FP_1.3C_AL_ES81
AS8943G-724G1TBn	LX.PUH 02.247	EMEA	Luxembourg	AS8943G-724G1TBn W7HP64ATLU3 MC BROADWAY_PRO1GBCFPssQ_3D4V3J 2*2G/500_L+500_L/BT/8L3.0/5R/CBUL_bgn_FP_1.3C_AL_IT41

Model	Acer P/N	RO	Country	Description
AS8943G-728G1.28TWn	LX.PUH 02.251	EMEA	Germany	AS8943G-728G1.28TWn W7HP64ATDE1 MC BROADWAY_PRO1GBCFPssQ_3D4V3J 2G+2G+2G+2G/640+640/BT/8L3.0/5R/ CBUL_bgn_FP_1.3C_AL_R_DE11
AS8943G-726G1.28TBn	LX.PUH 02.240	EMEA	Holland	AS8943G-726G1.28TBn W7HP64ATNL1 MC BROADWAY_PRO1GBCFPssQ_3D4V3J 2G+2G+2G/640+640/BT/8L3.0/5R/ CBUL_bgn_FP_1.3C_AL_NL11
AS8943G-724G1TBn	LX.PUH 02.239	EMEA	Germany	AS8943G-724G1TBn W7HP64ATDE1 MC BROADWAY_PRO1GBCFPssQ_3D4V3J 2*2G/500_L+500_L/BT/8L3.0/5R/ CBUL_bgn_FP_1.3C_AL_R_DE11
AS8943G-724G1TBn	LX.PUH 02.182	TWN	GCTWN	AS8943G-724G1TBn W7HP64ATTW1 MC BROADWAY_PRO1GBCFPssQ_3D4V3J 2*2G/500_L+500_L/BT/8L3.0/5R/ CBUL_bgn_FP_1.3C_AL_R_TC11
AS8943G-72161.28TWn	LX.PUH 02.245	EMEA	Holland	AS8943G-72161.28TWn W7HP64ATNL1 MC BROADWAY_PRO1GBCFPssQ_3D4V3J 4G+4G+4G+4G/640+640/BT/8L3.0/5R/ CBUL_bgn_FP_1.3C_AL_NL11
AS8943G-728G1.28TWn	LX.PUH 02.250	AAP	Philippines	AS8943G-728G1.28TWn EM W7HP64EMATPH1 MC BROADWAY_PRO1GBCFPssQ_3D4V3J 2*4G/640+640/BT/8L3.0/5R/ CBUL_bgn_FP_1.3C_AL_R_ES61
AS8943G-72161.28TWn	LX.PUH 02.246	EMEA	Belgium	AS8943G-72161.28TWn W7HP64ATBE1 MC BROADWAY_PRO1GBCFPssQ_3D4V3J 4G+4G+4G+4G/640+640/BT/8L3.0/5R/ CBUL_bgn_FP_1.3C_AL_NL11
AS8943G-72161.28TWn	LX.PUH 02.244	EMEA	Luxembourg	AS8943G-72161.28TWn W7HP64ATLU3 MC BROADWAY_PRO1GBCFPssQ_3D4V3J 4G+4G+4G+4G/640+640/BT/8L3.0/5R/ CBUL_bgn_FP_1.3C_AL_IT41
AS8943G-828G1.28TMn	LX.PUH 02.243	AAP	Philippines	AS8943G-828G1.28TMn EM W7HP64EMATPH1 MC BROADWAY_PRO1GBCFPssQ_3D4V3J 2*4G/640+640/BT/8L3.0/5R/ CBUL_bgn_FP_1.3C_AL_R_ES61
AS8943G-726G1.28TBn	LX.PUH 02.242	EMEA	Luxembourg	AS8943G-726G1.28TBn W7HP64ATLU3 MC BROADWAY_PRO1GBCFPssQ_3D4V3J 2G+2G+2G/640+640/BT/8L3.0/5R/ CBUL_bgn_FP_1.3C_AL_IT41
AS8943G-726G1.28TBn	LX.PUH 02.241	EMEA	Belgium	AS8943G-726G1.28TBn W7HP64ATBE1 MC BROADWAY_PRO1GBCFPssQ_3D4V3J 2G+2G+2G/640+640/BT/8L3.0/5R/ CBUL_bgn_FP_1.3C_AL_NL11
AS8943G-724G64Wn	LX.PUH 02.237	CHINA	China	AS8943G-724G64Wn W7HP64SCATCN1 MC BROADWAY_PRO1GBCFPssQ_3D4V3J 2*2G/640/BT/8L3.0/5R/CBUL_bgn_FP_1.3C_AL_SC14
AS8943G-72161.28TWn	LX.PUH 02.188	EMEA	Germany	AS8943G-72161.28TWn W7HP64ATDE1 MC BROADWAY_PRO1GBCFPssQ_3V3J 4G+4G+4G+4G/640+640/BT/8L3.0/5R/ CBUL_bgn_FP_1.3C_AL_R_DE11

Model	Acer P/N	RO	Country	Description
AS8943G-724G1TWn	LX.PUH 02.238	CHINA	Hong Kong	AS8943G-724G1TWn W7HP64ATHK2 MC BROADWAY_PRO1GBCFPssQ_3D4V3J 2*2G/500_L+500_L/BT/8L3.0/5R/CBUL_bgn_FP_1.3C_AL_ZH34
AS8943G-72101.28TWn	LX.PUH 02.236	AAP	Singapore	AS8943G-72101.28TWn W7HP64ATSG1 MC BROADWAY_PRO1GBCFPssQ_3D4V3J 4G+4G+2G/640+640/BT/8L3.0/5R/CBUL_bgn_FP_1.3C_AL_R_ZH31
AS8943G-724G1TMn	LX.PUH 02.235	EMEA	Middle East	AS8943G-724G1TMn EM W7HP64EMATME4 MC BROADWAY_PRO1GBCFPssQ_3D4V3J 2*2G/500_L+500_L/BT/8L3.0/5R/CBUL_bgn_FP_1.3C_AL_RU61
AS8943G-724G1TMn	LX.PUH 02.234	EMEA	Middle East	AS8943G-724G1TMn EM W7HP64EMATME2 MC BROADWAY_PRO1GBCFPssQ_3D4V3J 2*2G/500_L+500_L/BT/8L3.0/5R/CBUL_bgn_FP_1.3C_AL_ES61
AS8943G-724G1TMn	LX.PUH 02.233	EMEA	South Africa	AS8943G-724G1TMn EM W7HP64EMATZA2 MC BROADWAY_PRO1GBCFPssQ_3D4V3J 2*2G/500_L+500_L/BT/8L3.0/5R/CBUL_bgn_FP_1.3C_AL_ES61
AS8943G-724G1TMn	LX.PUH 02.232	EMEA	Turkey	AS8943G-724G1TMn EM W7HP64EMATTR1 MC BROADWAY_PRO1GBCFPssQ_3D4V3J 2*2G/500_L+500_L/BT/8L3.0/5R/CBUL_bgn_FP_1.3C_AL_TR31
AS8943G-724G1TMn	LX.PUH 02.231	EMEA	Middle East	AS8943G-724G1TMn EM W7HP64EMATMEB MC BROADWAY_PRO1GBCFPssQ_3D4V3J 2*2G/500_L+500_L/BT/8L3.0/5R/CBUL_bgn_FP_1.3C_AL_ARA1
AS8943G-724G1TMn	LX.PUH 02.230	EMEA	Middle East	AS8943G-724G1TMn EM W7HP64EMATME2 MC BROADWAY_PRO1GBCFPssQ_3D4V3J 2*2G/500_L+500_L/BT/8L3.0/5R/CBUL_bgn_FP_1.3C_AL_AR21
AS8943G-724G1TMn	LX.PUH 02.229	EMEA	South Africa	AS8943G-724G1TMn EM W7HP64EMATZA5 MC BROADWAY_PRO1GBCFPssQ_3D4V3J 2*2G/500_L+500_L/BT/8L3.0/5R/CBUL_bgn_FP_1.3C_AL_ES61
AS8943G-724G1TMn	LX.PUH 02.228	EMEA	Middle East	AS8943G-724G1TMn EM W7HP64EMATME4 MC BROADWAY_PRO1GBCFPssQ_3D4V3J 2*2G/500_L+500_L/BT/8L3.0/5R/CBUL_bgn_FP_1.3C_AL_ES61
AS8943G-724G1TMn	LX.PUH 02.227	EMEA	Middle East	AS8943G-724G1TMn EM W7HP64EMATME9 MC BROADWAY_PRO1GBCFPssQ_3D4V3J 2*2G/500_L+500_L/BT/8L3.0/5R/CBUL_bgn_FP_1.3C_AL_ES81
AS8943G-724G1TMn	LX.PUH 02.226	EMEA	Algeria	AS8943G-724G1TMn EM W7HP64EMATDZ1 MC BROADWAY_PRO1GBCFPssQ_3D4V3J 2*2G/500_L+500_L/BT/8L3.0/5R/CBUL_bgn_FP_1.3C_AL_ES81
AS8943G-724G1TMn	LX.PUH 02.225	EMEA	South Africa	AS8943G-724G1TMn EM W7HP64EMATZA1 MC BROADWAY_PRO1GBCFPssQ_3D4V3J 2*2G/500_L+500_L/BT/8L3.0/5R/CBUL_bgn_FP_1.3C_AL_ES81

Model	Acer P/N	RO	Country	Description
AS8943G-724G1TMn	LX.PUH 02.224	EMEA	Middle East	AS8943G-724G1TMn EM W7HP64EMATME2 MC BROADWAY_PRO1GBCFPssQ_3D4V3J 2*2G/500_L+500_L/BT/8L3.0/5R/CBUL_bgn_FP_1.3C_AL_AR11
AS8943G-724G1TMn	LX.PUH 02.223	EMEA	Middle East	AS8943G-724G1TMn EM W7HP64EMATME3 MC BROADWAY_PRO1GBCFPssQ_3D4V3J 2*2G/500_L+500_L/BT/8L3.0/5R/CBUL_bgn_FP_1.3C_AL_ES81
AS8943G-724G1TMn	LX.PUH 02.222	EMEA	Middle East	AS8943G-724G1TMn EM W7HP64EMATME6 MC BROADWAY_PRO1GBCFPssQ_3D4V3J 2*2G/500_L+500_L/BT/8L3.0/5R/CBUL_bgn_FP_1.3C_AL_ES61
AS8943G-724G1TMn	LX.PUH 02.221	EMEA	South Africa	AS8943G-724G1TMn EM W7HP64EMATZA4 MC BROADWAY_PRO1GBCFPssQ_3D4V3J 2*2G/500_L+500_L/BT/8L3.0/5R/CBUL_bgn_FP_1.3C_AL_ES61
AS8943G-724G1TMn	LX.PUH 02.220	EMEA	Germany	AS8943G-724G1TMn W7HP64ATDE1 MC BROADWAY_PRO1GBCFPssQ_3D4V3J 2*2G/500_L+500_L/BT/8L3.0/5R/CBUL_bgn_FP_1.3C_AL_DE11
AS8943G-724G1TMn	LX.PUH 02.219	EMEA	Poland	AS8943G-724G1TMn W7HP64ATPL1 MC BROADWAY_PRO1GBCFPssQ_3D4V3J 2*2G/500_L+500_L/BT/8L3.0/5R/CBUL_bgn_FP_1.3C_AL_PL11
AS8943G-724G1TMn	LX.PUH 02.218	EMEA	Baltic	AS8943G-724G1TMn W7HP64ATBC5 MC BROADWAY_PRO1GBCFPssQ_3D4V3J 2*2G/500_L+500_L/BT/8L3.0/5R/CBUL_bgn_FP_1.3C_AL_LT11
AS8943G-724G1TMn	LX.PUH 02.217	EMEA	Holland	AS8943G-724G1TMn W7HP64ATNL1 MC BROADWAY_PRO1GBCFPssQ_3D4V3J 2*2G/500_L+500_L/BT/8L3.0/5R/CBUL_bgn_FP_1.3C_AL_NL11
AS8943G-724G1TMn	LX.PUH 02.216	EMEA	Belgium	AS8943G-724G1TMn W7HP64ATBE1 MC BROADWAY_PRO1GBCFPssQ_3D4V3J 2*2G/500_L+500_L/BT/8L3.0/5R/CBUL_bgn_FP_1.3C_AL_NL11
AS8943G-724G1TMn	LX.PUH 02.215	EMEA	Switzerland	AS8943G-724G1TMn W7HP64ATCH1 MC BROADWAY_PRO1GBCFPssQ_3D4V3J 2*2G/500_L+500_L/BT/8L3.0/5R/CBUL_bgn_FP_1.3C_AL_IT41
AS8943G-724G1TMn	LX.PUH 02.214	EMEA	Luxembourg	AS8943G-724G1TMn W7HP64ATLU3 MC BROADWAY_PRO1GBCFPssQ_3D4V3J 2*2G/500_L+500_L/BT/8L3.0/5R/CBUL_bgn_FP_1.3C_AL_IT41
AS8943G-724G1TMn	LX.PUH 02.213	EMEA	Latvia	AS8943G-724G1TMn W7HP64ATLV1 MC BROADWAY_PRO1GBCFPssQ_3D4V3J 2*2G/500_L+500_L/BT/8L3.0/5R/CBUL_bgn_FP_1.3C_AL_LT11
AS8943G-724G1TMn	LX.PUH 02.212	EMEA	Latvia	AS8943G-724G1TMn W7HP64ATLV1 MC BROADWAY_PRO1GBCFPssQ_3D4V3J 2*2G/500_L+500_L/BT/8L3.0/5R/CBUL_bgn_FP_1.3C_AL_RU22

Model	Acer P/N	RO	Country	Description
AS8943G-724G1TMn	LX.PUH 02.211	EMEA	UK	AS8943G-724G1TMn W7HP64ATGB1 MC BROADWAY_PRO1GBCFPssQ_3D4V3J 2*2G/500_L+500_L/BT/8L3.0/5R/CBUL_bgn_FP_1.3C_AL_EN11
AS8943G-724G1TMn	LX.PUH 02.210	EMEA	Eastern Europe	AS8943G-724G1TMn W7HP64ATEU5 MC BROADWAY_PRO1GBCFPssQ_3D4V3J 2*2G/500_L+500_L/BT/8L3.0/5R/CBUL_bgn_FP_1.3C_AL_RO11
AS8943G-724G1TMn	LX.PUH 02.209	EMEA	Eastern Europe	AS8943G-724G1TMn W7HP64ATEU5 MC BROADWAY_PRO1GBCFPssQ_3D4V3J 2*2G/500_L+500_L/BT/8L3.0/5R/CBUL_bgn_FP_1.3C_AL_PL71
AS8943G-724G1TMn	LX.PUH 02.208	EMEA	Czech	AS8943G-724G1TMn W7HP64ATCZ2 MC BROADWAY_PRO1GBCFPssQ_3D4V3J 2*2G/500_L+500_L/BT/8L3.0/5R/CBUL_bgn_FP_1.3C_AL_SK11
AS8943G-724G1TMn	LX.PUH 02.207	EMEA	Hungary	AS8943G-724G1TMn W7HP64ATHU1 MC BROADWAY_PRO1GBCFPssQ_3D4V3J 2*2G/500_L+500_L/BT/8L3.0/5R/CBUL_bgn_FP_1.3C_AL_HU11
AS8943G-724G1TMn	LX.PUH 02.206	EMEA	Israel	AS8943G-724G1TMn W7HP64ATIL1 MC BROADWAY_PRO1GBCFPssQ_3D4V3J 2*2G/500_L+500_L/BT/8L3.0/5R/CBUL_bgn_FP_1.3C_AL_HE11
AS8943G-724G1TMn	LX.PUH 02.205	EMEA	Baltic	AS8943G-724G1TMn W7HP64ATBC4 MC BROADWAY_PRO1GBCFPssQ_3D4V3J 2*2G/500_L+500_L/BT/8L3.0/5R/CBUL_bgn_FP_1.3C_AL_LT11
AS8943G-724G1TMn	LX.PUH 02.204	EMEA	Portugal	AS8943G-724G1TMn W7HP64ATPT1 MC BROADWAY_PRO1GBCFPssQ_3D4V3J 2*2G/500_L+500_L/BT/8L3.0/5R/CBUL_bgn_FP_1.3C_AL_PT11
AS8943G-724G1TMn	LX.PUH 02.203	EMEA	Cyprus	AS8943G-724G1TMn W7HP64ATCY1 MC BROADWAY_PRO1GBCFPssQ_3D4V3J 2*2G/500_L+500_L/BT/8L3.0/5R/CBUL_bgn_FP_1.3C_AL_ES61
AS8943G-724G1TMn	LX.PUH 02.202	EMEA	Baltic	AS8943G-724G1TMn W7HP64ATBC3 MC BROADWAY_PRO1GBCFPssQ_3D4V3J 2*2G/500_L+500_L/BT/8L3.0/5R/CBUL_bgn_FP_1.3C_AL_SV21
AS8943G-724G1TMn	LX.PUH 02.201	EMEA	Serbia/Macedonia	AS8943G-724G1TMn W7HP64ATCS1 MC BROADWAY_PRO1GBCFPssQ_3D4V3J 2*2G/500_L+500_L/BT/8L3.0/5R/CBUL_bgn_FP_1.3C_AL_SL11
AS8943G-724G1TMn	LX.PUH 02.199	EMEA	Italy	AS8943G-724G1TMn W7HP64ATIT1 MC BROADWAY_PRO1GBCFPssQ_3D4V3J 2*2G/500_L+500_L/BT/8L3.0/5R/CBUL_bgn_FP_1.3C_AL_IT11
AS8943G-724G1TMn	LX.PUH 02.198	EMEA	Spain	AS8943G-724G1TMn W7HP64ATES1 MC BROADWAY_PRO1GBCFPssQ_3D4V3J 2*2G/500_L+500_L/BT/8L3.0/5R/CBUL_bgn_FP_1.3C_AL_ES51

Model	Acer P/N	RO	Country	Description
AS8943G-724G1TMn	LX.PUH 02.197	EMEA	Denmark	AS8943G-724G1TMn W7HP64ATDK2 MC BROADWAY_PRO1GBCFPssQ_3D4V3J 2*2G/500_L+500_L/BT/8L3.0/5R/CBUL_bgn_FP_1.3C_AL_ENS1
AS8943G-724G1TMn	LX.PUH 02.196	EMEA	Eastern Europe	AS8943G-724G1TMn W7HP64ATEU7 MC BROADWAY_PRO1GBCFPssQ_3D4V3J 2*2G/500_L+500_L/BT/8L3.0/5R/CBUL_bgn_FP_1.3C_AL_ENQ1
AS8943G-724G1TMn	LX.PUH 02.195	EMEA	Eastern Europe	AS8943G-724G1TMn W7HP64ATEU4 MC BROADWAY_PRO1GBCFPssQ_3D4V3J 2*2G/500_L+500_L/BT/8L3.0/5R/CBUL_bgn_FP_1.3C_AL_SV21
AS8943G-724G1TMn	LX.PUH 02.194	EMEA	Greece	AS8943G-724G1TMn W7HP64ATGR1 MC BROADWAY_PRO1GBCFPssQ_3D4V3J 2*2G/500_L+500_L/BT/8L3.0/5R/CBUL_bgn_FP_1.3C_AL_EL31
AS8943G-724G1TMn	LX.PUH 02.193	EMEA	Austria	AS8943G-724G1TMn W7HP64ATAT1 MC BROADWAY_PRO1GBCFPssQ_3D4V3J 2*2G/500_L+500_L/BT/8L3.0/5R/CBUL_bgn_FP_1.3C_AL_DE61
AS8943G-724G1TMn	LX.PUH 02.192	EMEA	France	AS8943G-724G1TMn W7HP64ATFR1 MC BROADWAY_PRO1GBCFPssQ_3D4V3J 2*2G/500_L+500_L/BT/8L3.0/5R/CBUL_bgn_FP_1.3C_AL_FR21
AS8943G-724G1TMn	LX.PUH 02.191	EMEA	Eastern Europe	AS8943G-724G1TMn W7HP64ATEU7 MC BROADWAY_PRO1GBCFPssQ_3D4V3J 2*2G/500_L+500_L/BT/8L3.0/5R/CBUL_bgn_FP_1.3C_AL_SL11
AS8943G-72161.28TWn	LX.PUH 02.190	AAP	Singapore	AS8943G-72161.28TWn W7HP64ATSG1 MC BROADWAY_PRO1GBCFPssQ_3D4V3J 4G+4G+4G+4G/640+640/BT/8L3.0/5R/CBUL_bgn_FP_1.3C_AL_R_ZH31
AS8943G-728G1.28TWn	LX.PUH 02.189	AAP	Singapore	AS8943G-728G1.28TWn W7HP64ATSG1 MC BROADWAY_PRO1GBCFPssQ_3D4V3J 2*4G/640+640/BT/8L3.0/5R/CBUL_bgn_FP_1.3C_AL_R_ZH31
AS8943G-728G1TBn	LX.PUH 02.096	EMEA	Denmark	AS8943G-728G1TBn W7HP64ATDK2 MC BROADWAY_PRO1GBCFPssQ_3D4V3J 2G+2G+2G+2G/500_L+500_L/BT/8L3.0/5R/CBUL_bgn_FP_1.3C_AL_ENS1
AS8943G-724G64Mn	LX.PUH 02.020	EMEA	Baltic	AS8943G-724G64Mn W7HP64ATBC4 MC BROADWAY_PRO1GBCFPssQ_3D4V3J 2*2G/640/BT/8L3.0/5R/CBUL_bgn_FP_1.3C_AL_RC_LT11
AS8943G-724G64Mn	LX.PUH 02.017	EMEA	Baltic	AS8943G-724G64Mn W7HP64ATBC3 MC BROADWAY_PRO1GBCFPssQ_3D4V3J 2*2G/640/BT/8L3.0/5R/CBUL_bgn_FP_1.3C_AL_RC_SV21
AS8943G-724G64Mn	LX.PUH 02.016	EMEA	Serbia/Macedonia	AS8943G-724G64Mn W7HP64ATCS1 MC BROADWAY_PRO1GBCFPssQ_3D4V3J 2*2G/640/BT/8L3.0/5R/CBUL_bgn_FP_1.3C_AL_RC_SL11

Model	Acer P/N	RO	Country	Description
AS8943G-728G64Bn	LX.PUH 02.073	EMEA	Baltic	AS8943G-728G64Bn W7HP64ATBC5 MC BROADWAY_PRO1GBCFPssQ_3D4V3J 2G+2G+2G+2G/640/BT/8L3.0/5R/ CBUL_bgn_FP_1.3C_AL_RC_LT11
AS8943G-728G64Bn	LX.PUH 02.060	EMEA	Baltic	AS8943G-728G64Bn W7HP64ATBC4 MC BROADWAY_PRO1GBCFPssQ_3D4V3J 2G+2G+2G+2G/640/BT/8L3.0/5R/ CBUL_bgn_FP_1.3C_AL_RC_LT11
AS8943G-728G64Bn	LX.PUH 02.057	EMEA	Baltic	AS8943G-728G64Bn W7HP64ATBC3 MC BROADWAY_PRO1GBCFPssQ_3D4V3J 2G+2G+2G+2G/640/BT/8L3.0/5R/ CBUL_bgn_FP_1.3C_AL_RC_SV21
AS8943G-728G64Bn	LX.PUH 02.056	EMEA	Serbia/ Macedonia	AS8943G-728G64Bn W7HP64ATCS1 MC BROADWAY_PRO1GBCFPssQ_3D4V3J 2G+2G+2G+2G/640/BT/8L3.0/5R/ CBUL_bgn_FP_1.3C_AL_RC_SL11
AS8943G-724G64Mn	LX.PUH 02.028	EMEA	Baltic	AS8943G-724G64Mn W7HP64ATBC5 MC BROADWAY_PRO1GBCFPssQ_3D4V3J 2*2G/640/BT/8L3.0/5R/ CBUL_bgn_FP_1.3C_AL_RC_LT11
AS8943G-728G1TMn	S2.PUH 02.001	WW	WW	AS8943G-728G1TMn W7HP64AWW1 MC BROADWAY_PRO1GBCFPssQ_3D4V3J 2G+2G+2G+2G/500_L+500_L/BT/8L3.0/5R/ CBUL_bgn_FP_1.3C_AL_ES62
AS8943G-728G1.28TWn	LX.PUH 02.184	EMEA	Switzerland	AS8943G-728G1.28TWn W7HP64ATCH1 MC BROADWAY_PRO1GBCFPssQ_3D4V3J 2G+2G+2G+2G/640+640/BT/8L3.0/5R/ CBUL_bgn_FP_1.3C_AL_IT41
AS8943G-728G1TMn	S2.PUH 02.001	WW	WW	AS8943G-728G1TMn W7HP64AWW1 MC BROADWAY_PRO1GBCFPssQ_3D4V3J 2G+2G+2G+2G/500_L+500_L/BT/8L3.0/5R/ CBUL_bgn_FP_1.3C_AL_ES62
AS8943G-728G1TWi	LX.PUH 02.187	EMEA	Russia	AS8943G-728G1TWi W7HP64RUATRU1 MC BROADWAY_PRO1GBCFPssQ_3D4V3J 2G+2G+2G+2G/500_L+500_L/BT/8L3.0/5R/ CBUL_bg_FP_1.3C_AL_R_RU11
AS8943G-728G1.28TWn	LX.PUH 02.185	EMEA	Switzerland	AS8943G-728G1.28TWn W7HP64ATCH1 MC BROADWAY_PRO1GBCFPssQ_3D4V3J 2G+2G+2G+2G/640+640/BT/8L3.0/5R/ CBUL_bgn_FP_1.3C_AL_R_IT41
AS8943G-728G1.28TBn	LX.PUH 02.166	EMEA	Poland	AS8943G-728G1.28TBn W7HP64ATPL1 MC BROADWAY_PRO1GBCFPssQ_3D4V3J 2G+2G+2G+2G/640+640/BT/8L3.0/5R/ CBUL_bgn_FP_1.3C_AL_PL11
AS8943G-728G1.28TBn	LX.PUH 02.164	EMEA	Baltic	AS8943G-728G1.28TBn W7HP64ATBC5 MC BROADWAY_PRO1GBCFPssQ_3D4V3J 2G+2G+2G+2G/640+640/BT/8L3.0/5R/ CBUL_bgn_FP_1.3C_AL_LT11
AS8943G-728G1.28TBn	LX.PUH 02.162	EMEA	Holland	AS8943G-728G1.28TBn W7HP64ATNL1 MC BROADWAY_PRO1GBCFPssQ_3D4V3J 2G+2G+2G+2G/640+640/BT/8L3.0/5R/ CBUL_bgn_FP_1.3C_AL_NL11

Model	Acer P/N	RO	Country	Description
AS8943G-728G1.28TBn	LX.PUH 02.157	EMEA	Eastern Europe	AS8943G-728G1.28TBn W7HP64ATEU5 MC BROADWAY_PRO1GBCFPssQ_3D4V3J 2G+2G+2G+2G/640+640/BT/8L3.0/5R/ CBUL_bgn_FP_1.3C_AL_RO11
AS8943G-728G1.28TBn	LX.PUH 02.156	EMEA	Eastern Europe	AS8943G-728G1.28TBn W7HP64ATEU5 MC BROADWAY_PRO1GBCFPssQ_3D4V3J 2G+2G+2G+2G/640+640/BT/8L3.0/5R/ CBUL_bgn_FP_1.3C_AL_PL71
AS8943G-728G1.28TBn	LX.PUH 02.178	EMEA	South Africa	AS8943G-728G1.28TBn EM W7HP64EMATZA2 MC BROADWAY_PRO1GBCFPssQ_3D4V3J 2G+2G+2G+2G/640+640/BT/8L3.0/5R/ CBUL_bgn_FP_1.3C_AL_ES61
AS8943G-728G1.28TBn	LX.PUH 02.168	EMEA	Middle East	AS8943G-728G1.28TBn EM W7HP64EMATME6 MC BROADWAY_PRO1GBCFPssQ_3D4V3J 2G+2G+2G+2G/640+640/BT/8L3.0/5R/ CBUL_bgn_FP_1.3C_AL_ES61
AS8943G-728G1.28TBn	LX.PUH 02.167	EMEA	South Africa	AS8943G-728G1.28TBn EM W7HP64EMATZA4 MC BROADWAY_PRO1GBCFPssQ_3D4V3J 2G+2G+2G+2G/640+640/BT/8L3.0/5R/ CBUL_bgn_FP_1.3C_AL_ES61
AS8943G-728G1.28TBn	LX.PUH 02.179	EMEA	Middle East	AS8943G-728G1.28TBn EM W7HP64EMATME2 MC BROADWAY_PRO1GBCFPssQ_3D4V3J 2G+2G+2G+2G/640+640/BT/8L3.0/5R/ CBUL_bgn_FP_1.3C_AL_ES61
AS8943G-728G1.28TBn	LX.PUH 02.175	EMEA	Middle East	AS8943G-728G1.28TBn EM W7HP64EMATME2 MC BROADWAY_PRO1GBCFPssQ_3D4V3J 2G+2G+2G+2G/640+640/BT/8L3.0/5R/ CBUL_bgn_FP_1.3C_AL_AR21
AS8943G-728G1.28TBn	LX.PUH 02.170	EMEA	Middle East	AS8943G-728G1.28TBn EM W7HP64EMATME2 MC BROADWAY_PRO1GBCFPssQ_3D4V3J 2G+2G+2G+2G/640+640/BT/8L3.0/5R/ CBUL_bgn_FP_1.3C_AL_AR11
AS8943G-728G1.28TBn	LX.PUH 02.176	EMEA	Middle East	AS8943G-728G1.28TBn EM W7HP64EMATMEB MC BROADWAY_PRO1GBCFPssQ_3D4V3J 2G+2G+2G+2G/640+640/BT/8L3.0/5R/ CBUL_bgn_FP_1.3C_AL_ARA1
AS8943G-728G1.28TBn	LX.PUH 02.152	EMEA	Israel	AS8943G-728G1.28TBn W7HP64ATIL1 MC BROADWAY_PRO1GBCFPssQ_3D4V3J 2G+2G+2G+2G/640+640/BT/8L3.0/5R/ CBUL_bgn_FP_1.3C_AL_HE11
AS8943G-728G1.28TBn	LX.PUH 02.154	EMEA	Czech	AS8943G-728G1.28TBn W7HP64ATCZ2 MC BROADWAY_PRO1GBCFPssQ_3D4V3J 2G+2G+2G+2G/640+640/BT/8L3.0/5R/ CBUL_bgn_FP_1.3C_AL_SK11
AS8943G-724G1TBn	LX.PUH 02.183	TWN	GCTWN	AS8943G-724G1TBn W7HP64ATTW1 MC BROADWAY_PRO1GBCFPssQ_3D4V3J 1*4G/500_L+500_L/BT/8L3.0/5R/ CBUL_bgn_FP_1.3C_AL_R_TC11
AS8943G-728G1.28TBn	LX.PUH 02.160	EMEA	Switzerland	AS8943G-728G1.28TBn W7HP64ATCH1 MC BROADWAY_PRO1GBCFPssQ_3D4V3J 2G+2G+2G+2G/640+640/BT/8L3.0/5R/ CBUL_bgn_FP_1.3C_AL_IT41

Model	Acer P/N	RO	Country	Description
AS8943G-728G1.28TBn	LX.PUH 02.163	EMEA	Luxembourg	AS8943G-728G1.28TBn W7HP64ATLU3 MC BROADWAY_PRO1GBCFPssQ_3D4V3J 2G+2G+2G+2G/640+640/BT/8L3.0/5R/ CBUL_bgn_FP_1.3C_AL_IT41
AS8943G-724G1TBn	LX.PUH 02.181	CHINA	Hong Kong	AS8943G-724G1TBn W7HP64ATHK2 MC BROADWAY_PRO1GBCFPssQ_3D4V3J 2*2G/500_L+500_L/BT/8L3.0/5R/ CBUL_bgn_FP_1.3C_AL_ZH34
AS8943G-728G1.28TBn	LX.PUH 02.180	EMEA	Middle East	AS8943G-728G1.28TBn EM W7HP64EMATME4 MC BROADWAY_PRO1GBCFPssQ_3D4V3J 2G+2G+2G+2G/640+640/BT/8L3.0/5R/ CBUL_bgn_FP_1.3C_AL_RU61
AS8943G-728G1.28TBn	LX.PUH 02.171	EMEA	Middle East	AS8943G-728G1.28TBn EM W7HP64EMATME4 MC BROADWAY_PRO1GBCFPssQ_3D4V3J 2G+2G+2G+2G/640+640/BT/8L3.0/5R/ CBUL_bgn_FP_1.3C_AL_ES61
AS8943G-728G1.28TBn	LX.PUH 02.159	EMEA	Latvia	AS8943G-728G1.28TBn W7HP64ATLV1 MC BROADWAY_PRO1GBCFPssQ_3D4V3J 2G+2G+2G+2G/640+640/BT/8L3.0/5R/ CBUL_bgn_FP_1.3C_AL_LT11
AS8943G-728G1.28TBn	LX.PUH 02.158	EMEA	Latvia	AS8943G-728G1.28TBn W7HP64ATLV1 MC BROADWAY_PRO1GBCFPssQ_3D4V3J 2G+2G+2G+2G/640+640/BT/8L3.0/5R/ CBUL_bgn_FP_1.3C_AL_RU22
AS8943G-728G1.28TBn	LX.PUH 02.165	EMEA	Germany	AS8943G-728G1.28TBn W7HP64ATDE1 MC BROADWAY_PRO1GBCFPssQ_3D4V3J 2G+2G+2G+2G/640+640/BT/8L3.0/5R/ CBUL_bgn_FP_1.3C_AL_DE11
AS8943G-728G1.28TBn	LX.PUH 02.155	EMEA	UK	AS8943G-728G1.28TBn W7HP64ATGB1 MC BROADWAY_PRO1GBCFPssQ_3D4V3J 2G+2G+2G+2G/640+640/BT/8L3.0/5R/ CBUL_bgn_FP_1.3C_AL_EN11
AS8943G-728G1.28TBn	LX.PUH 02.172	EMEA	South Africa	AS8943G-728G1.28TBn EM W7HP64EMATZA1 MC BROADWAY_PRO1GBCFPssQ_3D4V3J 2G+2G+2G+2G/640+640/BT/8L3.0/5R/ CBUL_bgn_FP_1.3C_AL_ES81
AS8943G-728G1.28TBn	LX.PUH 02.169	EMEA	Middle East	AS8943G-728G1.28TBn EM W7HP64EMATME3 MC BROADWAY_PRO1GBCFPssQ_3D4V3J 2G+2G+2G+2G/640+640/BT/8L3.0/5R/ CBUL_bgn_FP_1.3C_AL_ES81
AS8943G-728G1.28TBn	LX.PUH 02.177	EMEA	Turkey	AS8943G-728G1.28TBn EM W7HP64EMATTR1 MC BROADWAY_PRO1GBCFPssQ_3D4V3J 2G+2G+2G+2G/640+640/BT/8L3.0/5R/ CBUL_bgn_FP_1.3C_AL_TR31
AS8943G-728G1.28TBn	LX.PUH 02.153	EMEA	Hungary	AS8943G-728G1.28TBn W7HP64ATHU1 MC BROADWAY_PRO1GBCFPssQ_3D4V3J 2G+2G+2G+2G/640+640/BT/8L3.0/5R/ CBUL_bgn_FP_1.3C_AL_HU11
AS8943G-728G1.28TBn	LX.PUH 02.174	EMEA	Middle East	AS8943G-728G1.28TBn EM W7HP64EMATME9 MC BROADWAY_PRO1GBCFPssQ_3D4V3J 2G+2G+2G+2G/640+640/BT/8L3.0/5R/ CBUL_bgn_FP_1.3C_AL_ES81

Model	Acer P/N	RO	Country	Description
AS8943G-728G1.28T Bn	LX.PUH 02.173	EMEA	Algeria	AS8943G-728G1.28TBn EM W7HP64EMATDZ1 MC BROADWAY_PRO1GBCFPssQ_3D4V3J 2G+2G+2G+2G/640+640/BT/8L3.0/5R/ CBUL_bgn_FP_1.3C_AL_ES81
AS8943G-728G1TBn	LX.PUH 02.137	EMEA	Ukraine	AS8943G-728G1TBn W7HP64RUATUK1 MC BROADWAY_PRO1GBCFPssQ_3D4V3J 2G+2G+2G+2G/500_L+500_L/BT/8L3.0/5R/ CBUL_bgn_FP_1.3C_AL_RU61
AS8943G-728G1TBi	LX.PUH 02.136	EMEA	Russia	AS8943G-728G1TBi W7HP64RUATRU1 MC BROADWAY_PRO1GBCFPssQ_3D4V3J 2G+2G+2G+2G/500_L+500_L/BT/8L3.0/5R/ CBUL_bg_FP_1.3C_AL_RU11
AS8943G-728G1.28T Bn	LX.PUH 02.148	EMEA	Baltic	AS8943G-728G1.28TBn W7HP64ATBC3 MC BROADWAY_PRO1GBCFPssQ_3D4V3J 2G+2G+2G+2G/640+640/BT/8L3.0/5R/ CBUL_bgn_FP_1.3C_AL_SV21
AS8943G-728G1.28T Bn	LX.PUH 02.141	EMEA	Greece	AS8943G-728G1.28TBn W7HP64ATGR1 MC BROADWAY_PRO1GBCFPssQ_3D4V3J 2G+2G+2G+2G/640+640/BT/8L3.0/5R/ CBUL_bgn_FP_1.3C_AL_EL31
AS8943G-728G1.28T Bn	LX.PUH 02.151	EMEA	Baltic	AS8943G-728G1.28TBn W7HP64ATBC4 MC BROADWAY_PRO1GBCFPssQ_3D4V3J 2G+2G+2G+2G/640+640/BT/8L3.0/5R/ CBUL_bgn_FP_1.3C_AL_LT11
AS8943G-728G1.28T Bn	LX.PUH 02.139	EMEA	Eastern Europe	AS8943G-728G1.28TBn W7HP64ATEU7 MC BROADWAY_PRO1GBCFPssQ_3D4V3J 2G+2G+2G+2G/640+640/BT/8L3.0/5R/ CBUL_bgn_FP_1.3C_AL_SL11
AS8943G-728G1.28T Bn	LX.PUH 02.145	EMEA	Eastern Europe	AS8943G-728G1.28TBn W7HP64ATEU7 MC BROADWAY_PRO1GBCFPssQ_3D4V3J 2G+2G+2G+2G/640+640/BT/8L3.0/5R/ CBUL_bgn_FP_1.3C_AL_ENQ1
AS8943G-728G1.28T Bn	LX.PUH 02.147	EMEA	Serbia/ Macedonia	AS8943G-728G1.28TBn W7HP64ATCS1 MC BROADWAY_PRO1GBCFPssQ_3D4V3J 2G+2G+2G+2G/640+640/BT/8L3.0/5R/ CBUL_bgn_FP_1.3C_AL_SL11
AS8943G-728G1.28T Bn	LX.PUH 02.149	EMEA	Portugal	AS8943G-728G1.28TBn W7HP64ATPT1 MC BROADWAY_PRO1GBCFPssQ_3D4V3J 2G+2G+2G+2G/640+640/BT/8L3.0/5R/ CBUL_bgn_FP_1.3C_AL_PT11
AS8943G-728G1.28T Bn	LX.PUH 02.138	EMEA	France	AS8943G-728G1.28TBn W7HP64ATFR1 MC BROADWAY_PRO1GBCFPssQ_3D4V3J 2G+2G+2G+2G/640+640/BT/8L3.0/5R/ CBUL_bgn_FP_1.3C_AL_FR21
AS8943G-728G1.28T Bn	LX.PUH 02.140	EMEA	Austria	AS8943G-728G1.28TBn W7HP64ATAT1 MC BROADWAY_PRO1GBCFPssQ_3D4V3J 2G+2G+2G+2G/640+640/BT/8L3.0/5R/ CBUL_bgn_FP_1.3C_AL_DE61
AS8943G-728G1.28T Bn	LX.PUH 02.143	EMEA	Italy	AS8943G-728G1.28TBn W7HP64ATIT1 MC BROADWAY_PRO1GBCFPssQ_3D4V3J 2G+2G+2G+2G/640+640/BT/8L3.0/5R/ CBUL_bgn_FP_1.3C_AL_IT11

Model	Acer P/N	RO	Country	Description
AS8943G-728G1.28TBn	LX.PUH 02.146	EMEA	Denmark	AS8943G-728G1.28TBn W7HP64ATDK2 MC BROADWAY_PRO1GBCFPssQ_3D4V3J 2G+2G+2G+2G/640+640/BT/8L3.0/5R/ CBUL_bgn_FP_1.3C_AL_ENS1
AS8943G-728G1.28TBn	LX.PUH 02.150	EMEA	Cyprus	AS8943G-728G1.28TBn W7HP64ATCY1 MC BROADWAY_PRO1GBCFPssQ_3D4V3J 2G+2G+2G+2G/640+640/BT/8L3.0/5R/ CBUL_bgn_FP_1.3C_AL_ES61
AS8943G-728G1.28TBn	LX.PUH 02.142	EMEA	Spain	AS8943G-728G1.28TBn W7HP64ATES1 MC BROADWAY_PRO1GBCFPssQ_3D4V3J 2G+2G+2G+2G/640+640/BT/8L3.0/5R/ CBUL_bgn_FP_1.3C_AL_ES51
AS8943G-728G1.28TBn	LX.PUH 02.144	EMEA	Eastern Europe	AS8943G-728G1.28TBn W7HP64ATEU4 MC BROADWAY_PRO1GBCFPssQ_3D4V3J 2G+2G+2G+2G/640+640/BT/8L3.0/5R/ CBUL_bgn_FP_1.3C_AL_SV21
AS8943G-728G1TBn	LX.PUH 02.118	EMEA	Luxembourg	AS8943G-728G1TBn W7HP64ATLU3 MC BROADWAY_PRO1GBCFPssQ_3D4V3J 2G+2G+2G+2G/500_L+500_L/BT/8L3.0/5R/ CBUL_bgn_FP_1.3C_AL_IT41
AS8943G-728G1TBn	LX.PUH 02.135	EMEA	Middle East	AS8943G-728G1TBn EM W7HP64EMATME4 MC BROADWAY_PRO1GBCFPssQ_3D4V3J 2G+2G+2G+2G/500_L+500_L/BT/8L3.0/5R/ CBUL_bgn_FP_1.3C_AL_RU61
AS8943G-728G1TBn	LX.PUH 02.126	EMEA	Middle East	AS8943G-728G1TBn EM W7HP64EMATME4 MC BROADWAY_PRO1GBCFPssQ_3D4V3J 2G+2G+2G+2G/500_L+500_L/BT/8L3.0/5R/ CBUL_bgn_FP_1.3C_AL_ES61
AS8943G-728G1TBn	LX.PUH 02.114	EMEA	Latvia	AS8943G-728G1TBn W7HP64ATLV1 MC BROADWAY_PRO1GBCFPssQ_3D4V3J 2G+2G+2G+2G/500_L+500_L/BT/8L3.0/5R/ CBUL_bgn_FP_1.3C_AL_LT11
AS8943G-728G1TBn	LX.PUH 02.113	EMEA	Latvia	AS8943G-728G1TBn W7HP64ATLV1 MC BROADWAY_PRO1GBCFPssQ_3D4V3J 2G+2G+2G+2G/500_L+500_L/BT/8L3.0/5R/ CBUL_bgn_FP_1.3C_AL_RU22
AS8943G-728G1TBn	LX.PUH 02.102	EMEA	Baltic	AS8943G-728G1TBn W7HP64ATBC4 MC BROADWAY_PRO1GBCFPssQ_3D4V3J 2G+2G+2G+2G/500_L+500_L/BT/8L3.0/5R/ CBUL_bgn_FP_1.3C_AL_LT11
AS8943G-728G1TBn	LX.PUH 02.120	EMEA	Germany	AS8943G-728G1TBn W7HP64ATDE1 MC BROADWAY_PRO1GBCFPssQ_3D4V3J 2G+2G+2G+2G/500_L+500_L/BT/8L3.0/5R/ CBUL_bgn_FP_1.3C_AL_DE11
AS8943G-728G1TBn	LX.PUH 02.110	EMEA	Eastern Europe	AS8943G-728G1TBn W7HP64ATEU4 MC BROADWAY_PRO1GBCFPssQ_3D4V3J 2G+2G+2G+2G/500_L+500_L/BT/8L3.0/5R/ CBUL_bgn_FP_1.3C_AL_SV21
AS8943G-728G1TBn	LX.PUH 02.108	EMEA	Spain	AS8943G-728G1TBn W7HP64ATES1 MC BROADWAY_PRO1GBCFPssQ_3D4V3J 2G+2G+2G+2G/500_L+500_L/BT/8L3.0/5R/ CBUL_bgn_FP_1.3C_AL_ES51

Model	Acer P/N	RO	Country	Description
AS8943G-728G1TBn	LX.PUH 02.106	EMEA	UK	AS8943G-728G1TBn W7HP64ATGB1 MC BROADWAY_PRO1GBCFPssQ_3D4V3J 2G+2G+2G+2G/500_L+500_L/BT/8L3.0/5R/CBUL_bgn_FP_1.3C_AL_EN11
AS8943G-728G1TBn	LX.PUH 02.127	EMEA	South Africa	AS8943G-728G1TBn EM W7HP64EMATZA1 MC BROADWAY_PRO1GBCFPssQ_3D4V3J 2G+2G+2G+2G/500_L+500_L/BT/8L3.0/5R/CBUL_bgn_FP_1.3C_AL_ES81
AS8943G-728G1TBn	LX.PUH 02.124	EMEA	Middle East	AS8943G-728G1TBn EM W7HP64EMATME3 MC BROADWAY_PRO1GBCFPssQ_3D4V3J 2G+2G+2G+2G/500_L+500_L/BT/8L3.0/5R/CBUL_bgn_FP_1.3C_AL_ES81
AS8943G-728G1TBn	LX.PUH 02.111	EMEA	Eastern Europe	AS8943G-728G1TBn W7HP64ATEU7 MC BROADWAY_PRO1GBCFPssQ_3D4V3J 2G+2G+2G+2G/500_L+500_L/BT/8L3.0/5R/CBUL_bgn_FP_1.3C_AL_ENQ1
AS8943G-728G1TBn	LX.PUH 02.132	EMEA	Turkey	AS8943G-728G1TBn EM W7HP64EMATTR1 MC BROADWAY_PRO1GBCFPssQ_3D4V3J 2G+2G+2G+2G/500_L+500_L/BT/8L3.0/5R/CBUL_bgn_FP_1.3C_AL_TR31
AS8943G-728G1TBn	LX.PUH 02.104	EMEA	Hungary	AS8943G-728G1TBn W7HP64ATHU1 MC BROADWAY_PRO1GBCFPssQ_3D4V3J 2G+2G+2G+2G/500_L+500_L/BT/8L3.0/5R/CBUL_bgn_FP_1.3C_AL_HU11
AS8943G-728G1TBn	LX.PUH 02.128	EMEA	Algeria	AS8943G-728G1TBn EM W7HP64EMATDZ1 MC BROADWAY_PRO1GBCFPssQ_3D4V3J 2G+2G+2G+2G/500_L+500_L/BT/8L3.0/5R/CBUL_bgn_FP_1.3C_AL_ES81
AS8943G-728G1TBn	LX.PUH 02.115	EMEA	Switzerland	AS8943G-728G1TBn W7HP64ATCH1 MC BROADWAY_PRO1GBCFPssQ_3D4V3J 2G+2G+2G+2G/500_L+500_L/BT/8L3.0/5R/CBUL_bgn_FP_1.3C_AL_IT41
AS8943G-728G1TBn	LX.PUH 02.109	EMEA	Italy	AS8943G-728G1TBn W7HP64ATIT1 MC BROADWAY_PRO1GBCFPssQ_3D4V3J 2G+2G+2G+2G/500_L+500_L/BT/8L3.0/5R/CBUL_bgn_FP_1.3C_AL_IT11
AS8943G-728G1TBn	LX.PUH 02.116	EMEA	Belgium	AS8943G-728G1TBn W7HP64ATBE1 MC BROADWAY_PRO1GBCFPssQ_3D4V3J 2G+2G+2G+2G/500_L+500_L/BT/8L3.0/5R/CBUL_bgn_FP_1.3C_AL_NL11
AS8943G-728G1TBn	LX.PUH 02.105	EMEA	Czech	AS8943G-728G1TBn W7HP64ATCZ2 MC BROADWAY_PRO1GBCFPssQ_3D4V3J 2G+2G+2G+2G/500_L+500_L/BT/8L3.0/5R/CBUL_bgn_FP_1.3C_AL_SK11
AS8943G-728G1TBn	LX.PUH 02.103	EMEA	Israel	AS8943G-728G1TBn W7HP64ATIL1 MC BROADWAY_PRO1GBCFPssQ_3D4V3J 2G+2G+2G+2G/500_L+500_L/BT/8L3.0/5R/CBUL_bgn_FP_1.3C_AL_HE11
AS8943G-728G1TBn	LX.PUH 02.131	EMEA	Middle East	AS8943G-728G1TBn EM W7HP64EMATMEB MC BROADWAY_PRO1GBCFPssQ_3D4V3J 2G+2G+2G+2G/500_L+500_L/BT/8L3.0/5R/CBUL_bgn_FP_1.3C_AL_ARA1

Model	Acer P/N	RO	Country	Description
AS8943G-728G1TBn	LX.PUH 02.125	EMEA	Middle East	AS8943G-728G1TBn EM W7HP64EMATME2 MC BROADWAY_PRO1GBCFPssQ_3D4V3J 2G+2G+2G+2G/500_L+500_L/BT/8L3.0/5R/ CBUL_bgn_FP_1.3C_AL_AR11
AS8943G-728G1TBn	LX.PUH 02.130	EMEA	Middle East	AS8943G-728G1TBn EM W7HP64EMATME2 MC BROADWAY_PRO1GBCFPssQ_3D4V3J 2G+2G+2G+2G/500_L+500_L/BT/8L3.0/5R/ CBUL_bgn_FP_1.3C_AL_AR21
AS8943G-728G1TBn	LX.PUH 02.134	EMEA	Middle East	AS8943G-728G1TBn EM W7HP64EMATME2 MC BROADWAY_PRO1GBCFPssQ_3D4V3J 2G+2G+2G+2G/500_L+500_L/BT/8L3.0/5R/ CBUL_bgn_FP_1.3C_AL_ES61
AS8943G-728G1TBn	LX.PUH 02.122	EMEA	South Africa	AS8943G-728G1TBn EM W7HP64EMATZA4 MC BROADWAY_PRO1GBCFPssQ_3D4V3J 2G+2G+2G+2G/500_L+500_L/BT/8L3.0/5R/ CBUL_bgn_FP_1.3C_AL_ES61
AS8943G-728G1TBn	LX.PUH 02.123	EMEA	Middle East	AS8943G-728G1TBn EM W7HP64EMATME6 MC BROADWAY_PRO1GBCFPssQ_3D4V3J 2G+2G+2G+2G/500_L+500_L/BT/8L3.0/5R/ CBUL_bgn_FP_1.3C_AL_ES61
AS8943G-728G1TBn	LX.PUH 02.133	EMEA	South Africa	AS8943G-728G1TBn EM W7HP64EMATZA2 MC BROADWAY_PRO1GBCFPssQ_3D4V3J 2G+2G+2G+2G/500_L+500_L/BT/8L3.0/5R/ CBUL_bgn_FP_1.3C_AL_ES61
AS8943G-728G1TBn	LX.PUH 02.107	EMEA	Eastern Europe	AS8943G-728G1TBn W7HP64ATEU5 MC BROADWAY_PRO1GBCFPssQ_3D4V3J 2G+2G+2G+2G/500_L+500_L/BT/8L3.0/5R/ CBUL_bgn_FP_1.3C_AL_PL71
AS8943G-728G1TBn	LX.PUH 02.112	EMEA	Eastern Europe	AS8943G-728G1TBn W7HP64ATEU5 MC BROADWAY_PRO1GBCFPssQ_3D4V3J 2G+2G+2G+2G/500_L+500_L/BT/8L3.0/5R/ CBUL_bgn_FP_1.3C_AL_RO11
AS8943G-728G1TBn	LX.PUH 02.117	EMEA	Holland	AS8943G-728G1TBn W7HP64ATNL1 MC BROADWAY_PRO1GBCFPssQ_3D4V3J 2G+2G+2G+2G/500_L+500_L/BT/8L3.0/5R/ CBUL_bgn_FP_1.3C_AL_NL11
AS8943G-728G1TBn	LX.PUH 02.121	EMEA	Poland	AS8943G-728G1TBn W7HP64ATPL1 MC BROADWAY_PRO1GBCFPssQ_3D4V3J 2G+2G+2G+2G/500_L+500_L/BT/8L3.0/5R/ CBUL_bgn_FP_1.3C_AL_PL11
AS8943G-728G1TBn	LX.PUH 02.119	EMEA	Baltic	AS8943G-728G1TBn W7HP64ATBC5 MC BROADWAY_PRO1GBCFPssQ_3D4V3J 2G+2G+2G+2G/500_L+500_L/BT/8L3.0/5R/ CBUL_bgn_FP_1.3C_AL_LT11
AS8943G-728G64Bn	LX.PUH 02.091	EMEA	Ukraine	AS8943G-728G64Bn W7HP64RUATUK1 MC BROADWAY_PRO1GBCFPssQ_3D4V3J 2G+2G+2G+2G/640/BT/8L3.0/5R/ CBUL_bgn_FP_1.3C_AL_R_RU61
AS8943G-728G1TBn	LX.PUH 02.099	EMEA	Portugal	AS8943G-728G1TBn W7HP64ATPT1 MC BROADWAY_PRO1GBCFPssQ_3D4V3J 2G+2G+2G+2G/500_L+500_L/BT/8L3.0/5R/ CBUL_bgn_FP_1.3C_AL_PT11

Model	Acer P/N	RO	Country	Description
AS8943G-728G1TBn	LX.PUH 02.098	EMEA	Baltic	AS8943G-728G1TBn W7HP64ATBC3 MC BROADWAY_PRO1GBCFPssQ_3D4V3J 2G+2G+2G+2G/500_L+500_L/BT/8L3.0/5R/ CBUL_bgn_FP_1.3C_AL_SV21
AS8943G-728G1TBn	LX.PUH 02.095	EMEA	Greece	AS8943G-728G1TBn W7HP64ATGR1 MC BROADWAY_PRO1GBCFPssQ_3D4V3J 2G+2G+2G+2G/500_L+500_L/BT/8L3.0/5R/ CBUL_bgn_FP_1.3C_AL_EL31
AS8943G-728G64Bn	LX.PUH 02.086	EMEA	Turkey	AS8943G-728G64Bn EM W7HP64EMATTR1 MC BROADWAY_PRO1GBCFPssQ_3D4V3J 2G+2G+2G+2G/640/BT/8L3.0/5R/ CBUL_bgn_FP_1.3C_AL_R_TR31
AS8943G-728G1TBn	LX.PUH 02.097	EMEA	Serbia/ Macedonia	AS8943G-728G1TBn W7HP64ATCS1 MC BROADWAY_PRO1GBCFPssQ_3D4V3J 2G+2G+2G+2G/500_L+500_L/BT/8L3.0/5R/ CBUL_bgn_FP_1.3C_AL_SL11
AS8943G-728G64Bn	LX.PUH 02.087	EMEA	South Africa	AS8943G-728G64Bn EM W7HP64EMATZA2 MC BROADWAY_PRO1GBCFPssQ_3D4V3J 2G+2G+2G+2G/640/BT/8L3.0/5R/ CBUL_bgn_FP_1.3C_AL_R_ES61
AS8943G-728G1TBn	LX.PUH 02.093	EMEA	Eastern Europe	AS8943G-728G1TBn W7HP64ATEU7 MC BROADWAY_PRO1GBCFPssQ_3D4V3J 2G+2G+2G+2G/500_L+500_L/BT/8L3.0/5R/ CBUL_bgn_FP_1.3C_AL_SL11
AS8943G-728G1TBn	LX.PUH 02.092	EMEA	France	AS8943G-728G1TBn W7HP64ATFR1 MC BROADWAY_PRO1GBCFPssQ_3D4V3J 2G+2G+2G+2G/500_L+500_L/BT/8L3.0/5R/ CBUL_bgn_FP_1.3C_AL_FR21
AS8943G-728G64Bn	LX.PUH 02.088	EMEA	Middle East	AS8943G-728G64Bn EM W7HP64EMATME2 MC BROADWAY_PRO1GBCFPssQ_3D4V3J 2G+2G+2G+2G/640/BT/8L3.0/5R/ CBUL_bgn_FP_1.3C_AL_R_ES61
AS8943G-728G1TBn	LX.PUH 02.094	EMEA	Austria	AS8943G-728G1TBn W7HP64ATAT1 MC BROADWAY_PRO1GBCFPssQ_3D4V3J 2G+2G+2G+2G/500_L+500_L/BT/8L3.0/5R/ CBUL_bgn_FP_1.3C_AL_DE61
AS8943G-728G1TBn	LX.PUH 02.101	EMEA	Cyprus	AS8943G-728G1TBn W7HP64ATCY1 MC BROADWAY_PRO1GBCFPssQ_3D4V3J 2G+2G+2G+2G/500_L+500_L/BT/8L3.0/5R/ CBUL_bgn_FP_1.3C_AL_ES61
AS8943G-728G64Bn	LX.PUH 02.089	EMEA	Middle East	AS8943G-728G64Bn EM W7HP64EMATME4 MC BROADWAY_PRO1GBCFPssQ_3D4V3J 2G+2G+2G+2G/640/BT/8L3.0/5R/ CBUL_bgn_FP_1.3C_AL_R_RU61
AS8943G-728G64Bn	LX.PUH 02.072	EMEA	Luxembourg	AS8943G-728G64Bn W7HP64ATLU3 MC BROADWAY_PRO1GBCFPssQ_3D4V3J 2G+2G+2G+2G/640/BT/8L3.0/5R/ CBUL_bgn_FP_1.3C_AL_R_IT41
AS8943G-728G64Bn	LX.PUH 02.075	EMEA	Poland	AS8943G-728G64Bn W7HP64ATPL1 MC BROADWAY_PRO1GBCFPssQ_3D4V3J 2G+2G+2G+2G/640/BT/8L3.0/5R/ CBUL_bgn_FP_1.3C_AL_R_PL11

Model	Acer P/N	RO	Country	Description
AS8943G-728G64Bn	LX.PUH 02.080	EMEA	Middle East	AS8943G-728G64Bn EM W7HP64EMATME4 MC BROADWAY_PRO1GBCFPssQ_3D4V3J 2G+2G+2G+2G/640/BT/8L3.0/5R/ CBUL_bgn_FP_1.3C_AL_R_ES61
AS8943G-728G64Bn	LX.PUH 02.068	EMEA	Latvia	AS8943G-728G64Bn W7HP64ATLV1 MC BROADWAY_PRO1GBCFPssQ_3D4V3J 2G+2G+2G+2G/640/BT/8L3.0/5R/ CBUL_bgn_FP_1.3C_AL_R_LT11
AS8943G-728G64Bn	LX.PUH 02.067	EMEA	Latvia	AS8943G-728G64Bn W7HP64ATLV1 MC BROADWAY_PRO1GBCFPssQ_3D4V3J 2G+2G+2G+2G/640/BT/8L3.0/5R/ CBUL_bgn_FP_1.3C_AL_R_RU22
AS8943G-728G64Bn	LX.PUH 02.074	EMEA	Germany	AS8943G-728G64Bn W7HP64ATDE1 MC BROADWAY_PRO1GBCFPssQ_3D4V3J 2G+2G+2G+2G/640/BT/8L3.0/5R/ CBUL_bgn_FP_1.3C_AL_R_DE11
AS8943G-728G64Bn	LX.PUH 02.053	EMEA	Eastern Europe	AS8943G-728G64Bn W7HP64ATEU4 MC BROADWAY_PRO1GBCFPssQ_3D4V3J 2G+2G+2G+2G/640/BT/8L3.0/5R/ CBUL_bgn_FP_1.3C_AL_R_SV21
AS8943G-728G64Bn	LX.PUH 02.051	EMEA	Spain	AS8943G-728G64Bn W7HP64ATES1 MC BROADWAY_PRO1GBCFPssQ_3D4V3J 2G+2G+2G+2G/640/BT/8L3.0/5R/ CBUL_bgn_FP_1.3C_AL_R_ES51
AS8943G-728G64Bn	LX.PUH 02.064	EMEA	UK	AS8943G-728G64Bn W7HP64ATGB1 MC BROADWAY_PRO1GBCFPssQ_3D4V3J 2G+2G+2G+2G/640/BT/8L3.0/5R/ CBUL_bgn_FP_1.3C_AL_R_EN11
AS8943G-728G64Bn	LX.PUH 02.059	EMEA	Cyprus	AS8943G-728G64Bn W7HP64ATCY1 MC BROADWAY_PRO1GBCFPssQ_3D4V3J 2G+2G+2G+2G/640/BT/8L3.0/5R/ CBUL_bgn_FP_1.3C_AL_R_ES61
AS8943G-728G64Bn	LX.PUH 02.081	EMEA	South Africa	AS8943G-728G64Bn EM W7HP64EMATZA1 MC BROADWAY_PRO1GBCFPssQ_3D4V3J 2G+2G+2G+2G/640/BT/8L3.0/5R/ CBUL_bgn_FP_1.3C_AL_R_ES81
AS8943G-728G64Bn	LX.PUH 02.078	EMEA	Middle East	AS8943G-728G64Bn EM W7HP64EMATME3 MC BROADWAY_PRO1GBCFPssQ_3D4V3J 2G+2G+2G+2G/640/BT/8L3.0/5R/ CBUL_bgn_FP_1.3C_AL_R_ES81
AS8943G-728G64Bn	LX.PUH 02.054	EMEA	Eastern Europe	AS8943G-728G64Bn W7HP64ATEU7 MC BROADWAY_PRO1GBCFPssQ_3D4V3J 2G+2G+2G+2G/640/BT/8L3.0/5R/ CBUL_bgn_FP_1.3C_AL_R_ENQ1
AS8943G-728G64Bn	LX.PUH 02.062	EMEA	Hungary	AS8943G-728G64Bn W7HP64ATHU1 MC BROADWAY_PRO1GBCFPssQ_3D4V3J 2G+2G+2G+2G/640/BT/8L3.0/5R/ CBUL_bgn_FP_1.3C_AL_R_HU11
AS8943G-728G64Bn	LX.PUH 02.083	EMEA	Middle East	AS8943G-728G64Bn EM W7HP64EMATME9 MC BROADWAY_PRO1GBCFPssQ_3D4V3J 2G+2G+2G+2G/640/BT/8L3.0/5R/ CBUL_bgn_FP_1.3C_AL_R_ES81

Model	Acer P/N	RO	Country	Description
AS8943G-728G64Bn	LX.PUH 02.082	EMEA	Algeria	AS8943G-728G64Bn EM W7HP64EMATDZ1 MC BROADWAY_PRO1GBCFPssQ_3D4V3J 2G+2G+2G+2G/640/BT/8L3.0/5R/ CBUL_bgn_FP_1.3C_AL_R_ES81
AS8943G-728G64Bn	LX.PUH 02.069	EMEA	Switzerland	AS8943G-728G64Bn W7HP64ATCH1 MC BROADWAY_PRO1GBCFPssQ_3D4V3J 2G+2G+2G+2G/640/BT/8L3.0/5R/ CBUL_bgn_FP_1.3C_AL_R_IT41
AS8943G-728G64Bn	LX.PUH 02.058	EMEA	Portugal	AS8943G-728G64Bn W7HP64ATPT1 MC BROADWAY_PRO1GBCFPssQ_3D4V3J 2G+2G+2G+2G/640/BT/8L3.0/5R/ CBUL_bgn_FP_1.3C_AL_R_PT11
AS8943G-728G64Bn	LX.PUH 02.052	EMEA	Italy	AS8943G-728G64Bn W7HP64ATIT1 MC BROADWAY_PRO1GBCFPssQ_3D4V3J 2G+2G+2G+2G/640/BT/8L3.0/5R/ CBUL_bgn_FP_1.3C_AL_R_IT11
AS8943G-728G64Bn	LX.PUH 02.070	EMEA	Belgium	AS8943G-728G64Bn W7HP64ATBE1 MC BROADWAY_PRO1GBCFPssQ_3D4V3J 2G+2G+2G+2G/640/BT/8L3.0/5R/ CBUL_bgn_FP_1.3C_AL_R_NL11
AS8943G-728G64Bn	LX.PUH 02.063	EMEA	Czech	AS8943G-728G64Bn W7HP64ATCZ2 MC BROADWAY_PRO1GBCFPssQ_3D4V3J 2G+2G+2G+2G/640/BT/8L3.0/5R/ CBUL_bgn_FP_1.3C_AL_R_SK11
AS8943G-728G64Bn	LX.PUH 02.061	EMEA	Israel	AS8943G-728G64Bn W7HP64ATIL1 MC BROADWAY_PRO1GBCFPssQ_3D4V3J 2G+2G+2G+2G/640/BT/8L3.0/5R/ CBUL_bgn_FP_1.3C_AL_R_HE11
AS8943G-728G64Bn	LX.PUH 02.055	EMEA	Denmark	AS8943G-728G64Bn W7HP64ATDK2 MC BROADWAY_PRO1GBCFPssQ_3D4V3J 2G+2G+2G+2G/640/BT/8L3.0/5R/ CBUL_bgn_FP_1.3C_AL_R_ENS1
AS8943G-728G64Bn	LX.PUH 02.085	EMEA	Middle East	AS8943G-728G64Bn EM W7HP64EMATMEB MC BROADWAY_PRO1GBCFPssQ_3D4V3J 2G+2G+2G+2G/640/BT/8L3.0/5R/ CBUL_bgn_FP_1.3C_AL_R_ARA1
AS8943G-728G64Bn	LX.PUH 02.079	EMEA	Middle East	AS8943G-728G64Bn EM W7HP64EMATME2 MC BROADWAY_PRO1GBCFPssQ_3D4V3J 2G+2G+2G+2G/640/BT/8L3.0/5R/ CBUL_bgn_FP_1.3C_AL_R_AR11
AS8943G-728G64Bn	LX.PUH 02.084	EMEA	Middle East	AS8943G-728G64Bn EM W7HP64EMATME2 MC BROADWAY_PRO1GBCFPssQ_3D4V3J 2G+2G+2G+2G/640/BT/8L3.0/5R/ CBUL_bgn_FP_1.3C_AL_R_AR21
AS8943G-728G64Bn	LX.PUH 02.076	EMEA	South Africa	AS8943G-728G64Bn EM W7HP64EMATZA4 MC BROADWAY_PRO1GBCFPssQ_3D4V3J 2G+2G+2G+2G/640/BT/8L3.0/5R/ CBUL_bgn_FP_1.3C_AL_R_ES61
AS8943G-728G64Bn	LX.PUH 02.077	EMEA	Middle East	AS8943G-728G64Bn EM W7HP64EMATME6 MC BROADWAY_PRO1GBCFPssQ_3D4V3J 2G+2G+2G+2G/640/BT/8L3.0/5R/ CBUL_bgn_FP_1.3C_AL_R_ES61

Model	Acer P/N	RO	Country	Description
AS8943G-728G64Bn	LX.PUH 02.071	EMEA	Holland	AS8943G-728G64Bn W7HP64ATNL1 MC BROADWAY_PRO1GBCFPssQ_3D4V3J 2G+2G+2G+2G/640/BT/8L3.0/5R/ CBUL_bgn_FP_1.3C_AL_R_NL11
AS8943G-728G64Bn	LX.PUH 02.065	EMEA	Eastern Europe	AS8943G-728G64Bn W7HP64ATEU5 MC BROADWAY_PRO1GBCFPssQ_3D4V3J 2G+2G+2G+2G/640/BT/8L3.0/5R/ CBUL_bgn_FP_1.3C_AL_R_PL71
AS8943G-724G64Mn	LX.PUH 02.046	EMEA	Ukraine	AS8943G-724G64Mn W7HP64RUATUK1 MC BROADWAY_PRO1GBCFPssQ_3D4V3J 2*2G/640/BT/8L3.0/5R/ CBUL_bgn_FP_1.3C_AL_R_RU61
AS8943G-728G64Bn	LX.PUH 02.047	EMEA	France	AS8943G-728G64Bn W7HP64ATFR1 MC BROADWAY_PRO1GBCFPssQ_3D4V3J 2G+2G+2G+2G/640/BT/8L3.0/5R/ CBUL_bgn_FP_1.3C_AL_R_FR21
AS8943G-728G64Bn	LX.PUH 02.048	EMEA	Eastern Europe	AS8943G-728G64Bn W7HP64ATEU7 MC BROADWAY_PRO1GBCFPssQ_3D4V3J 2G+2G+2G+2G/640/BT/8L3.0/5R/ CBUL_bgn_FP_1.3C_AL_R_SL11
AS8943G-728G64Bn	LX.PUH 02.049	EMEA	Austria	AS8943G-728G64Bn W7HP64ATAT1 MC BROADWAY_PRO1GBCFPssQ_3D4V3J 2G+2G+2G+2G/640/BT/8L3.0/5R/ CBUL_bgn_FP_1.3C_AL_R_DE61
AS8943G-728G64Bn	LX.PUH 02.050	EMEA	Greece	AS8943G-728G64Bn W7HP64ATGR1 MC BROADWAY_PRO1GBCFPssQ_3D4V3J 2G+2G+2G+2G/640/BT/8L3.0/5R/ CBUL_bgn_FP_1.3C_AL_R_EL31
AS8943G-724G64Mi	LX.PUH 02.045	EMEA	Russia	AS8943G-724G64Mi W7HP64RUATRU1 MC BROADWAY_PRO1GBCFPssQ_3D4V3J 2*2G/640/BT/8L3.0/5R/CBUL_bg_FP_1.3C_AL_R_RU11
AS8943G-724G64Mn	LX.PUH 02.043	EMEA	Middle East	AS8943G-724G64Mn EM W7HP64EMATME2 MC BROADWAY_PRO1GBCFPssQ_3D4V3J 2*2G/640/BT/8L3.0/5R/ CBUL_bgn_FP_1.3C_AL_R_ES61
AS8943G-724G64Mn	LX.PUH 02.039	EMEA	Middle East	AS8943G-724G64Mn EM W7HP64EMATME2 MC BROADWAY_PRO1GBCFPssQ_3D4V3J 2*2G/640/BT/8L3.0/5R/ CBUL_bgn_FP_1.3C_AL_R_AR21
AS8943G-724G64Mn	LX.PUH 02.034	EMEA	Middle East	AS8943G-724G64Mn EM W7HP64EMATME2 MC BROADWAY_PRO1GBCFPssQ_3D4V3J 2*2G/640/BT/8L3.0/5R/CBUL_bgn_FP_1.3C_AL_AR11
AS8943G-724G64Mn	LX.PUH 02.040	EMEA	Middle East	AS8943G-724G64Mn EM W7HP64EMATMEB MC BROADWAY_PRO1GBCFPssQ_3D4V3J 2*2G/640/BT/8L3.0/5R/ CBUL_bgn_FP_1.3C_AL_R_ARA1
AS8943G-724G64Mn	LX.PUH 02.015	EMEA	Denmark	AS8943G-724G64Mn W7HP64ATDK2 MC BROADWAY_PRO1GBCFPssQ_3D4V3J 2*2G/640/BT/8L3.0/5R/CBUL_bgn_FP_1.3C_AL_ENS1
AS8943G-724G64Mn	LX.PUH 02.002	EMEA	Israel	AS8943G-724G64Mn W7HP64ATIL1 MC BROADWAY_PRO1GBCFPssQ_3D4V3J 2*2G/640/BT/8L3.0/5R/CBUL_bgn_FP_1.3C_AL_HE11

Model	Acer P/N	RO	Country	Description
AS8943G-724G64Mn	LX.PUH 02.004	EMEA	Czech	AS8943G-724G64Mn W7HP64ATCZ2 MC BROADWAY_PRO1GBCFPssQ_3D4V3J 2*2G/640/BT/8L3.0/5R/CBUL_bgn_FP_1.3C_AL_SK11
AS8943G-724G64Mn	LX.PUH 02.025	EMEA	Belgium	AS8943G-724G64Mn W7HP64ATBE1 MC BROADWAY_PRO1GBCFPssQ_3D4V3J 2*2G/640/BT/8L3.0/5R/CBUL_bgn_FP_1.3C_AL_NL11
AS8943G-724G64Mn	LX.PUH 02.012	EMEA	Italy	AS8943G-724G64Mn W7HP64ATIT1 MC BROADWAY_PRO1GBCFPssQ_3D4V3J 2*2G/640/BT/8L3.0/5R/CBUL_bgn_FP_1.3C_AL_IT11
AS8943G-724G64Mn	LX.PUH 02.018	EMEA	Portugal	AS8943G-724G64Mn W7HP64ATPT1 MC BROADWAY_PRO1GBCFPssQ_3D4V3J 2*2G/640/BT/8L3.0/5R/CBUL_bgn_FP_1.3C_AL_PT11
AS8943G-724G64Mn	LX.PUH 02.024	EMEA	Switzerland	AS8943G-724G64Mn W7HP64ATCH1 MC BROADWAY_PRO1GBCFPssQ_3D4V3J 2*2G/640/BT/8L3.0/5R/CBUL_bgn_FP_1.3C_AL_IT41
AS8943G-724G64Mn	LX.PUH 02.027	EMEA	Luxembourg	AS8943G-724G64Mn W7HP64ATLU3 MC BROADWAY_PRO1GBCFPssQ_3D4V3J 2*2G/640/BT/8L3.0/5R/CBUL_bgn_FP_1.3C_AL_IT41
AS8943G-724G64Mn	LX.PUH 02.001	CHINA	China	AS8943G-724G64Mn W7HP64SCATCN1 MC BROADWAY_PRO1GBCFPssQ_3D4V3J 2*2G/640/BT/8L3.0/5R/CBUL_bgn_FP_1.3C_AL_SC14
AS8943G-724G64Mn	LX.PUH 02.044	EMEA	Middle East	AS8943G-724G64Mn EM W7HP64EMATME4 MC BROADWAY_PRO1GBCFPssQ_3D4V3J 2*2G/640/BT/8L3.0/5R/CBUL_bgn_FP_1.3C_AL_R_RU61
AS8943G-724G64Mn	LX.PUH 02.035	EMEA	Middle East	AS8943G-724G64Mn EM W7HP64EMATME4 MC BROADWAY_PRO1GBCFPssQ_3D4V3J 2*2G/640/BT/8L3.0/5R/CBUL_bgn_FP_1.3C_AL_ES61
AS8943G-724G64Mn	LX.PUH 02.023	EMEA	Latvia	AS8943G-724G64Mn W7HP64ATLV1 MC BROADWAY_PRO1GBCFPssQ_3D4V3J 2*2G/640/BT/8L3.0/5R/CBUL_bgn_FP_1.3C_AL_LT11
AS8943G-724G64Mn	LX.PUH 02.022	EMEA	Latvia	AS8943G-724G64Mn W7HP64ATLV1 MC BROADWAY_PRO1GBCFPssQ_3D4V3J 2*2G/640/BT/8L3.0/5R/CBUL_bgn_FP_1.3C_AL_RU22
AS8943G-724G64Mn	LX.PUH 02.029	EMEA	Germany	AS8943G-724G64Mn W7HP64ATDE1 MC BROADWAY_PRO1GBCFPssQ_3D4V3J 2*2G/640/BT/8L3.0/5R/CBUL_bgn_FP_1.3C_AL_DE11
AS8943G-724G64Mn	LX.PUH 02.013	EMEA	Eastern Europe	AS8943G-724G64Mn W7HP64ATEU4 MC BROADWAY_PRO1GBCFPssQ_3D4V3J 2*2G/640/BT/8L3.0/5R/CBUL_bgn_FP_1.3C_AL_SV21
AS8943G-724G64Mn	LX.PUH 02.011	EMEA	Spain	AS8943G-724G64Mn W7HP64ATES1 MC BROADWAY_PRO1GBCFPssQ_3D4V3J 2*2G/640/BT/8L3.0/5R/CBUL_bgn_FP_1.3C_AL_ES51
AS8943G-724G64Mn	LX.PUH 02.019	EMEA	Cyprus	AS8943G-724G64Mn W7HP64ATCY1 MC BROADWAY_PRO1GBCFPssQ_3D4V3J 2*2G/640/BT/8L3.0/5R/CBUL_bgn_FP_1.3C_AL_ES61
AS8943G-724G64Mn	LX.PUH 02.005	EMEA	UK	AS8943G-724G64Mn W7HP64ATGB1 MC BROADWAY_PRO1GBCFPssQ_3D4V3J 2*2G/640/BT/8L3.0/5R/CBUL_bgn_FP_1.3C_AL_EN11

Model	Acer P/N	RO	Country	Description
AS8943G-724G64Mn	LX.PUH 02.036	EMEA	South Africa	AS8943G-724G64Mn EM W7HP64EMATZA1 MC BROADWAY_PRO1GBCFPssQ_3D4V3J 2*2G/640/BT/8L3.0/5R/CBUL_bgn_FP_1.3C_AL_R_ES81
AS8943G-724G64Mn	LX.PUH 02.033	EMEA	Middle East	AS8943G-724G64Mn EM W7HP64EMATME3 MC BROADWAY_PRO1GBCFPssQ_3D4V3J 2*2G/640/BT/8L3.0/5R/CBUL_bgn_FP_1.3C_AL_ES81
AS8943G-724G64Mn	LX.PUH 02.007	EMEA	France	AS8943G-724G64Mn W7HP64ATFR1 MC BROADWAY_PRO1GBCFPssQ_3D4V3J 2*2G/640/BT/8L3.0/5R/CBUL_bgn_FP_1.3C_AL_FR21
AS8943G-724G64Mn	LX.PUH 02.014	EMEA	Eastern Europe	AS8943G-724G64Mn W7HP64ATEU7 MC BROADWAY_PRO1GBCFPssQ_3D4V3J 2*2G/640/BT/8L3.0/5R/CBUL_bgn_FP_1.3C_AL_ENQ1
AS8943G-724G64Mn	LX.PUH 02.008	EMEA	Eastern Europe	AS8943G-724G64Mn W7HP64ATEU7 MC BROADWAY_PRO1GBCFPssQ_3D4V3J 2*2G/640/BT/8L3.0/5R/CBUL_bgn_FP_1.3C_AL_SL11
AS8943G-724G64Mn	LX.PUH 02.041	EMEA	Turkey	AS8943G-724G64Mn EM W7HP64EMATTR1 MC BROADWAY_PRO1GBCFPssQ_3D4V3J 2*2G/640/BT/8L3.0/5R/CBUL_bgn_FP_1.3C_AL_R_TR31
AS8943G-724G64Mn	LX.PUH 02.010	EMEA	Greece	AS8943G-724G64Mn W7HP64ATGR1 MC BROADWAY_PRO1GBCFPssQ_3D4V3J 2*2G/640/BT/8L3.0/5R/CBUL_bgn_FP_1.3C_AL_EL31
AS8943G-724G64Mn	LX.PUH 02.003	EMEA	Hungary	AS8943G-724G64Mn W7HP64ATHU1 MC BROADWAY_PRO1GBCFPssQ_3D4V3J 2*2G/640/BT/8L3.0/5R/CBUL_bgn_FP_1.3C_AL_HU11
AS8943G-724G64Mn	LX.PUH 02.038	EMEA	Middle East	AS8943G-724G64Mn EM W7HP64EMATME9 MC BROADWAY_PRO1GBCFPssQ_3D4V3J 2*2G/640/BT/8L3.0/5R/CBUL_bgn_FP_1.3C_AL_R_ES81
AS8943G-724G64Mn	LX.PUH 02.037	EMEA	Algeria	AS8943G-724G64Mn EM W7HP64EMATDZ1 MC BROADWAY_PRO1GBCFPssQ_3D4V3J 2*2G/640/BT/8L3.0/5R/CBUL_bgn_FP_1.3C_AL_R_ES81
AS8943G-724G64Mn	LX.PUH 02.031	EMEA	South Africa	AS8943G-724G64Mn EM W7HP64EMATZA4 MC BROADWAY_PRO1GBCFPssQ_3D4V3J 2*2G/640/BT/8L3.0/5R/CBUL_bgn_FP_1.3C_AL_ES61
AS8943G-724G64Mn	LX.PUH 02.032	EMEA	Middle East	AS8943G-724G64Mn EM W7HP64EMATME6 MC BROADWAY_PRO1GBCFPssQ_3D4V3J 2*2G/640/BT/8L3.0/5R/CBUL_bgn_FP_1.3C_AL_ES61
AS8943G-724G64Mn	LX.PUH 02.042	EMEA	South Africa	AS8943G-724G64Mn EM W7HP64EMATZA2 MC BROADWAY_PRO1GBCFPssQ_3D4V3J 2*2G/640/BT/8L3.0/5R/CBUL_bgn_FP_1.3C_AL_R_ES61
AS8943G-724G64Mn	LX.PUH 02.006	EMEA	Eastern Europe	AS8943G-724G64Mn W7HP64ATEU5 MC BROADWAY_PRO1GBCFPssQ_3D4V3J 2*2G/640/BT/8L3.0/5R/CBUL_bgn_FP_1.3C_AL_PL71
AS8943G-724G64Mn	LX.PUH 02.021	EMEA	Eastern Europe	AS8943G-724G64Mn W7HP64ATEU5 MC BROADWAY_PRO1GBCFPssQ_3D4V3J 2*2G/640/BT/8L3.0/5R/CBUL_bgn_FP_1.3C_AL_RO11

Model	Acer P/N	RO	Country	Description
AS8943G-724G64Mn	LX.PUH 02.030	EMEA	Poland	AS8943G-724G64Mn W7HP64ATPL1 MC BROADWAY_PRO1GBCFPssQ_3D4V3J 2*2G/640/BT/8L3.0/5R/CBUL_bgn_FP_1.3C_AL_PL11
AS8943G-724G64Mn	LX.PUH 02.026	EMEA	Holland	AS8943G-724G64Mn W7HP64ATNL1 MC BROADWAY_PRO1GBCFPssQ_3D4V3J 2*2G/640/BT/8L3.0/5R/CBUL_bgn_FP_1.3C_AL_NL11
AS8943G-434G64Bn	LX.PU1 02.103	EMEA	Czech	AS8943G-434G64Bn W7HP64ATCZ2 MC BROADWAY_PRO1GBCFPss_3V3J 2*2G/640/BT/8L3.0/5R/CBUL_bgn_FP_1.3C_AL_SK11
AS8943G-438G64Bn	LX.PU1 02.095	EMEA	Switzerland	AS8943G-438G64Bn W7HP64ATCH1 MC BROADWAY_PRO1GBCFPss_3V3J 2*4G/640/BT/8L3.0/5R/CBUL_bgn_FP_1.3C_AL_IT41
AS8943G-526G1TWn	LX.PU1 02.102	EMEA	Turkey	AS8943G-526G1TWn EM W7HP64EMATTR1 MC BROADWAY_PRO1GBCFPss_3V3J 4G+2G/500_L+500_L/BT/8L3.0/5R/CBUL_bgn_FP_1.3C_AL_TR31
AS8943G-626G1TWn	LX.PU1 02.101	EMEA	Turkey	AS8943G-626G1TWn EM W7HP64EMATTR1 MC BROADWAY_PRO1GBCFPss_3V3J 4G+2G/500_L+500_L/BT/8L3.0/5R/CBUL_bgn_FP_1.3C_AL_TR31
AS8943G-434G64Mn	LX.PU1 02.020	EMEA	Eastern Europe	AS8943G-434G64Mn W7HP64ATEU5 MC BROADWAY_PRO1GBCFPss_3V3J 2*2G/640/8L3.0/5R/CBUL_bgn_FP_1.3C_AL_RO11
AS8943G-434G64Bi	LX.PU1 02.099	EMEA	Russia	AS8943G-434G64Bi W7HP64RUATRU1 MC BROADWAY_PRO1GBCFPss_3V3J 2*2G/640/BT/8L3.0/5R/CBUL_bgn_FP_1.3C_AL_R_RU11
AS8943G-624G1.28T Bn	LX.PU1 02.093	EMEA	France	AS8943G-624G1.28TBn W7HP64ATFR1 MC BROADWAY_PRO1GBCFPss_3V3J 2*2G/640+640/BT/8L3.0/5R/CBUL_bgn_FP_1.3C_AL_FR21
AS8943G-624G1TMn	LX.PU1 02.094	EMEA	France	AS8943G-624G1TMn W7HP64ATFR1 MC BROADWAY_PRO1GBCFPss_3V3J 2*2G/500_L+500_L/BT/8L3.0/5R/CBUL_bgn_FP_1.3C_AL_FR21
AS8943G-434G50Mn	LX.PU1 02.092	EMEA	Denmark	AS8943G-434G50Mn W7HP64ATDK2 MC BROADWAY_PRO1GBCFPss_3V3J 2*2G/500_L/BT/8L3.0/5R/CBUL_bgn_FP_1.3C_AL_ENS1
AS8943G-436G1TWn	LX.PU1 02.098	EMEA	Turkey	AS8943G-436G1TWn EM W7HP64EMATTR1 MC BROADWAY_PRO1GBCFPss_3V3J 4G+2G/500_L+500_L/BT/8L3.0/5R/CBUL_bgn_FP_1.3C_AL_TR31
AS8943G-434G64Mn	LX.PU1 02.097	EMEA	Turkey	AS8943G-434G64Mn EM W7HP64EMATTR1 MC BROADWAY_PRO1GBCFPss_3V3J 2*2G/640/BT/8L3.0/5R/CBUL_bgn_FP_1.3C_AL_TR31
AS8943G-438G1TBn	LX.PU1 02.096	EMEA	Switzerland	AS8943G-438G1TBn W7HP64ATCH1 MC BROADWAY_PRO1GBCFPss_3V3J 2*4G/500_L+500_L/BT/8L3.0/5R/CBUL_bgn_FP_1.3C_AL_IT41
AS8943G-624G64Mn	LX.PU1 02.091	CHINA	Hong Kong	AS8943G-624G64Mn W7HP64ATHK2 MC BROADWAY_PRO1GBCFPss_3V3J 2*2G/640/BT/8L3.0/5R/CBUL_bgn_FP_1.3C_AL_ZH34

Model	Acer P/N	RO	Country	Description
AS8943G-436G1TBn	LX.PU1 02.090	EMEA	Ukraine	AS8943G-436G1TBn W7HP64RUATUK1 MC BROADWAY_PRO1GBCFPss_3V3J 4G+2G/ 500_L+500_L/BT/8L3.0/5R/ CBUL_bgn_FP_1.3C_AL_RU61
AS8943G-436G1TBi	LX.PU1 02.089	EMEA	Russia	AS8943G-436G1TBi W7HP64RUATRU1 MC BROADWAY_PRO1GBCFPss_3V3J 4G+2G/ 500_L+500_L/BT/8L3.0/5R/ CBUL_bg_FP_1.3C_AL_RU11
AS8943G-436G1TBn	LX.PU1 02.088	EMEA	Middle East	AS8943G-436G1TBn EM W7HP64EMATME4 MC BROADWAY_PRO1GBCFPss_3V3J 4G+2G/ 500_L+500_L/BT/8L3.0/5R/ CBUL_bgn_FP_1.3C_AL_RU61
AS8943G-436G1TBn	LX.PU1 02.087	EMEA	Middle East	AS8943G-436G1TBn EM W7HP64EMATME2 MC BROADWAY_PRO1GBCFPss_3V3J 4G+2G/ 500_L+500_L/BT/8L3.0/5R/ CBUL_bgn_FP_1.3C_AL_ES61
AS8943G-436G1TBn	LX.PU1 02.086	EMEA	South Africa	AS8943G-436G1TBn EM W7HP64EMATZA2 MC BROADWAY_PRO1GBCFPss_3V3J 4G+2G/ 500_L+500_L/BT/8L3.0/5R/ CBUL_bgn_FP_1.3C_AL_ES61
AS8943G-436G1TBn	LX.PU1 02.085	EMEA	Turkey	AS8943G-436G1TBn EM W7HP64EMATTR1 MC BROADWAY_PRO1GBCFPss_3V3J 4G+2G/ 500_L+500_L/BT/8L3.0/5R/ CBUL_bgn_FP_1.3C_AL_TR31
AS8943G-436G1TBn	LX.PU1 02.084	EMEA	Middle East	AS8943G-436G1TBn EM W7HP64EMATMEB MC BROADWAY_PRO1GBCFPss_3V3J 4G+2G/ 500_L+500_L/BT/8L3.0/5R/ CBUL_bgn_FP_1.3C_AL_ARA1
AS8943G-436G1TBn	LX.PU1 02.082	EMEA	Middle East	AS8943G-436G1TBn EM W7HP64EMATME9 MC BROADWAY_PRO1GBCFPss_3V3J 4G+2G/ 500_L+500_L/BT/8L3.0/5R/ CBUL_bgn_FP_1.3C_AL_ES81
AS8943G-436G1TBn	LX.PU1 02.083	EMEA	Middle East	AS8943G-436G1TBn EM W7HP64EMATME2 MC BROADWAY_PRO1GBCFPss_3V3J 4G+2G/ 500_L+500_L/BT/8L3.0/5R/ CBUL_bgn_FP_1.3C_AL_AR21
AS8943G-436G1TBn	LX.PU1 02.081	EMEA	Algeria	AS8943G-436G1TBn EM W7HP64EMATDZ1 MC BROADWAY_PRO1GBCFPss_3V3J 4G+2G/ 500_L+500_L/BT/8L3.0/5R/ CBUL_bgn_FP_1.3C_AL_ES81
AS8943G-436G1TBn	LX.PU1 02.080	EMEA	South Africa	AS8943G-436G1TBn EM W7HP64EMATZA1 MC BROADWAY_PRO1GBCFPss_3V3J 4G+2G/ 500_L+500_L/BT/8L3.0/5R/ CBUL_bgn_FP_1.3C_AL_ES81
AS8943G-436G1TBn	LX.PU1 02.079	EMEA	Middle East	AS8943G-436G1TBn EM W7HP64EMATME4 MC BROADWAY_PRO1GBCFPss_3V3J 4G+2G/ 500_L+500_L/BT/8L3.0/5R/ CBUL_bgn_FP_1.3C_AL_ES61
AS8943G-436G1TBn	LX.PU1 02.078	EMEA	Middle East	AS8943G-436G1TBn EM W7HP64EMATME2 MC BROADWAY_PRO1GBCFPss_3V3J 4G+2G/ 500_L+500_L/BT/8L3.0/5R/ CBUL_bgn_FP_1.3C_AL_AR11

Model	Acer P/N	RO	Country	Description
AS8943G-436G1TBn	LX.PU1 02.077	EMEA	Middle East	AS8943G-436G1TBn EM W7HP64EMATME3 MC BROADWAY_PRO1GBCFPss_3V3J 4G+2G/ 500_L+500_L/BT/8L3.0/5R/ CBUL_bgn_FP_1.3C_AL_ES81
AS8943G-436G1TBn	LX.PU1 02.076	EMEA	Middle East	AS8943G-436G1TBn EM W7HP64EMATME6 MC BROADWAY_PRO1GBCFPss_3V3J 4G+2G/ 500_L+500_L/BT/8L3.0/5R/ CBUL_bgn_FP_1.3C_AL_ES61
AS8943G-436G1TBn	LX.PU1 02.075	EMEA	South Africa	AS8943G-436G1TBn EM W7HP64EMATZA4 MC BROADWAY_PRO1GBCFPss_3V3J 4G+2G/ 500_L+500_L/BT/8L3.0/5R/ CBUL_bgn_FP_1.3C_AL_ES61
AS8943G-436G1TBn	LX.PU1 02.074	EMEA	Poland	AS8943G-436G1TBn W7HP64ATPL1 MC BROADWAY_PRO1GBCFPss_3V3J 4G+2G/ 500_L+500_L/BT/8L3.0/5R/ CBUL_bgn_FP_1.3C_AL_PL11
AS8943G-436G1TBn	LX.PU1 02.073	EMEA	Germany	AS8943G-436G1TBn W7HP64ATDE1 MC BROADWAY_PRO1GBCFPss_3V3J 4G+2G/ 500_L+500_L/BT/8L3.0/5R/ CBUL_bgn_FP_1.3C_AL_DE11
AS8943G-436G1TBn	LX.PU1 02.072	EMEA	Baltic	AS8943G-436G1TBn W7HP64ATBC5 MC BROADWAY_PRO1GBCFPss_3V3J 4G+2G/ 500_L+500_L/BT/8L3.0/5R/ CBUL_bgn_FP_1.3C_AL_LT11
AS8943G-436G1TBn	LX.PU1 02.071	EMEA	Luxembourg	AS8943G-436G1TBn W7HP64ATLU3 MC BROADWAY_PRO1GBCFPss_3V3J 4G+2G/ 500_L+500_L/BT/8L3.0/5R/ CBUL_bgn_FP_1.3C_AL_IT41
AS8943G-436G1TBn	LX.PU1 02.070	EMEA	Holland	AS8943G-436G1TBn W7HP64ATNL1 MC BROADWAY_PRO1GBCFPss_3V3J 4G+2G/ 500_L+500_L/BT/8L3.0/5R/ CBUL_bgn_FP_1.3C_AL_NL11
AS8943G-436G1TBn	LX.PU1 02.069	EMEA	Belgium	AS8943G-436G1TBn W7HP64ATBE1 MC BROADWAY_PRO1GBCFPss_3V3J 4G+2G/ 500_L+500_L/BT/8L3.0/5R/ CBUL_bgn_FP_1.3C_AL_NL11
AS8943G-436G1TBn	LX.PU1 02.068	EMEA	Switzerland	AS8943G-436G1TBn W7HP64ATCH1 MC BROADWAY_PRO1GBCFPss_3V3J 4G+2G/ 500_L+500_L/BT/8L3.0/5R/ CBUL_bgn_FP_1.3C_AL_IT41
AS8943G-436G1TBn	LX.PU1 02.067	EMEA	Latvia	AS8943G-436G1TBn W7HP64ATLV1 MC BROADWAY_PRO1GBCFPss_3V3J 4G+2G/ 500_L+500_L/BT/8L3.0/5R/ CBUL_bgn_FP_1.3C_AL_LT11
AS8943G-436G1TBn	LX.PU1 02.066	EMEA	Latvia	AS8943G-436G1TBn W7HP64ATLV1 MC BROADWAY_PRO1GBCFPss_3V3J 4G+2G/ 500_L+500_L/BT/8L3.0/5R/ CBUL_bgn_FP_1.3C_AL_RU22
AS8943G-436G1TBn	LX.PU1 02.065	EMEA	Eastern Europe	AS8943G-436G1TBn W7HP64ATEU5 MC BROADWAY_PRO1GBCFPss_3V3J 4G+2G/ 500_L+500_L/BT/8L3.0/5R/ CBUL_bgn_FP_1.3C_AL_RO11

Model	Acer P/N	RO	Country	Description
AS8943G-436G1TBn	LX.PU1 02.064	EMEA	Eastern Europe	AS8943G-436G1TBn W7HP64ATEU5 MC BROADWAY_PRO1GBCFPss_3V3J 4G+2G/ 500_L+500_L/BT/8L3.0/5R/ CBUL_bgn_FP_1.3C_AL_PL71
AS8943G-436G1TBn	LX.PU1 02.063	EMEA	UK	AS8943G-436G1TBn W7HP64ATGB1 MC BROADWAY_PRO1GBCFPss_3V3J 4G+2G/ 500_L+500_L/BT/8L3.0/5R/ CBUL_bgn_FP_1.3C_AL_EN11
AS8943G-436G1TBn	LX.PU1 02.062	EMEA	Czech	AS8943G-436G1TBn W7HP64ATCZ2 MC BROADWAY_PRO1GBCFPss_3V3J 4G+2G/ 500_L+500_L/BT/8L3.0/5R/ CBUL_bgn_FP_1.3C_AL_SK11
AS8943G-436G1TBn	LX.PU1 02.061	EMEA	Hungary	AS8943G-436G1TBn W7HP64ATHU1 MC BROADWAY_PRO1GBCFPss_3V3J 4G+2G/ 500_L+500_L/BT/8L3.0/5R/ CBUL_bgn_FP_1.3C_AL_HU11
AS8943G-436G1TBn	LX.PU1 02.060	EMEA	Israel	AS8943G-436G1TBn W7HP64ATIL1 MC BROADWAY_PRO1GBCFPss_3V3J 4G+2G/ 500_L+500_L/BT/8L3.0/5R/ CBUL_bgn_FP_1.3C_AL_HE11
AS8943G-436G1TBn	LX.PU1 02.059	EMEA	Baltic	AS8943G-436G1TBn W7HP64ATBC4 MC BROADWAY_PRO1GBCFPss_3V3J 4G+2G/ 500_L+500_L/BT/8L3.0/5R/ CBUL_bgn_FP_1.3C_AL_LT11
AS8943G-436G1TBn	LX.PU1 02.058	EMEA	Cyprus	AS8943G-436G1TBn W7HP64ATCY1 MC BROADWAY_PRO1GBCFPss_3V3J 4G+2G/ 500_L+500_L/BT/8L3.0/5R/ CBUL_bgn_FP_1.3C_AL_ES61
AS8943G-436G1TBn	LX.PU1 02.057	EMEA	Portugal	AS8943G-436G1TBn W7HP64ATPT1 MC BROADWAY_PRO1GBCFPss_3V3J 4G+2G/ 500_L+500_L/BT/8L3.0/5R/ CBUL_bgn_FP_1.3C_AL_PT11
AS8943G-436G1TBn	LX.PU1 02.056	EMEA	Baltic	AS8943G-436G1TBn W7HP64ATBC3 MC BROADWAY_PRO1GBCFPss_3V3J 4G+2G/ 500_L+500_L/BT/8L3.0/5R/ CBUL_bgn_FP_1.3C_AL_SV21
AS8943G-436G1TBn	LX.PU1 02.055	EMEA	Serbia/ Macedonia	AS8943G-436G1TBn W7HP64ATCS1 MC BROADWAY_PRO1GBCFPss_3V3J 4G+2G/ 500_L+500_L/BT/8L3.0/5R/ CBUL_bgn_FP_1.3C_AL_SL11
AS8943G-436G1TBn	LX.PU1 02.054	EMEA	Denmark	AS8943G-436G1TBn W7HP64ATDK2 MC BROADWAY_PRO1GBCFPss_3V3J 4G+2G/ 500_L+500_L/BT/8L3.0/5R/ CBUL_bgn_FP_1.3C_AL_ENS1
AS8943G-436G1TBn	LX.PU1 02.053	EMEA	Eastern Europe	AS8943G-436G1TBn W7HP64ATEU7 MC BROADWAY_PRO1GBCFPss_3V3J 4G+2G/ 500_L+500_L/BT/8L3.0/5R/ CBUL_bgn_FP_1.3C_AL_ENQ1
AS8943G-436G1TBn	LX.PU1 02.052	EMEA	Eastern Europe	AS8943G-436G1TBn W7HP64ATEU4 MC BROADWAY_PRO1GBCFPss_3V3J 4G+2G/ 500_L+500_L/BT/8L3.0/5R/ CBUL_bgn_FP_1.3C_AL_SV21

Model	Acer P/N	RO	Country	Description
AS8943G-436G1TBn	LX.PU1 02.051	EMEA	Italy	AS8943G-436G1TBn W7HP64ATIT1 MC BROADWAY_PRO1GBCFPss_3V3J 4G+2G/ 500_L+500_L/BT/8L3.0/5R/ CBUL_bgn_FP_1.3C_AL_IT11
AS8943G-436G1TBn	LX.PU1 02.050	EMEA	Spain	AS8943G-436G1TBn W7HP64ATES1 MC BROADWAY_PRO1GBCFPss_3V3J 4G+2G/ 500_L+500_L/BT/8L3.0/5R/ CBUL_bgn_FP_1.3C_AL_ES51
AS8943G-436G1TBn	LX.PU1 02.049	EMEA	Greece	AS8943G-436G1TBn W7HP64ATGR1 MC BROADWAY_PRO1GBCFPss_3V3J 4G+2G/ 500_L+500_L/BT/8L3.0/5R/ CBUL_bgn_FP_1.3C_AL_EL31
AS8943G-436G1TBn	LX.PU1 02.048	EMEA	Austria	AS8943G-436G1TBn W7HP64ATAT1 MC BROADWAY_PRO1GBCFPss_3V3J 4G+2G/ 500_L+500_L/BT/8L3.0/5R/ CBUL_bgn_FP_1.3C_AL_DE61
AS8943G-436G1TBn	LX.PU1 02.046	EMEA	France	AS8943G-436G1TBn W7HP64ATFR1 MC BROADWAY_PRO1GBCFPss_3V3J 4G+2G/ 500_L+500_L/BT/8L3.0/5R/ CBUL_bgn_FP_1.3C_AL_FR21
AS8943G-436G1TBn	LX.PU1 02.047	EMEA	Eastern Europe	AS8943G-436G1TBn W7HP64ATEU7 MC BROADWAY_PRO1GBCFPss_3V3J 4G+2G/ 500_L+500_L/BT/8L3.0/5R/ CBUL_bgn_FP_1.3C_AL_SL11
AS8943G-434G64Mn	LX.PU1 02.045	EMEA	Ukraine	AS8943G-434G64Mn W7HP64RUATUK1 MC BROADWAY_PRO1GBCFPss_3V3J 2*2G/640/ 8L3.0/5R/CBUL_bgn_FP_1.3C_AL_RU61
AS8943G-434G64Mi	LX.PU1 02.044	EMEA	Russia	AS8943G-434G64Mi W7HP64RUATRU1 MC BROADWAY_PRO1GBCFPss_3V3J 2*2G/640/ 8L3.0/5R/CBUL_bgn_FP_1.3C_AL_RU11
AS8943G-434G64Mn	LX.PU1 02.043	EMEA	Middle East	AS8943G-434G64Mn EM W7HP64EMATME4 MC BROADWAY_PRO1GBCFPss_3V3J 2*2G/640/ 8L3.0/5R/CBUL_bgn_FP_1.3C_AL_RU61
AS8943G-434G64Mn	LX.PU1 02.042	EMEA	Middle East	AS8943G-434G64Mn EM W7HP64EMATME2 MC BROADWAY_PRO1GBCFPss_3V3J 2*2G/640/ 8L3.0/5R/CBUL_bgn_FP_1.3C_AL_ES61
AS8943G-434G64Mn	LX.PU1 02.041	EMEA	South Africa	AS8943G-434G64Mn EM W7HP64EMATZA2 MC BROADWAY_PRO1GBCFPss_3V3J 2*2G/640/ 8L3.0/5R/CBUL_bgn_FP_1.3C_AL_ES61
AS8943G-434G64Mn	LX.PU1 02.040	EMEA	Turkey	AS8943G-434G64Mn EM W7HP64EMATTR1 MC BROADWAY_PRO1GBCFPss_3V3J 2*2G/640/ 8L3.0/5R/CBUL_bgn_FP_1.3C_AL_TR31
AS8943G-434G64Mn	LX.PU1 02.039	EMEA	Middle East	AS8943G-434G64Mn EM W7HP64EMATMEB MC BROADWAY_PRO1GBCFPss_3V3J 2*2G/640/ 8L3.0/5R/CBUL_bgn_FP_1.3C_AL_ARA1
AS8943G-434G64Mn	LX.PU1 02.038	EMEA	Middle East	AS8943G-434G64Mn EM W7HP64EMATME2 MC BROADWAY_PRO1GBCFPss_3V3J 2*2G/640/ 8L3.0/5R/CBUL_bgn_FP_1.3C_AL_AR21
AS8943G-434G64Mn	LX.PU1 02.037	EMEA	Middle East	AS8943G-434G64Mn EM W7HP64EMATME9 MC BROADWAY_PRO1GBCFPss_3V3J 2*2G/640/ 8L3.0/5R/CBUL_bgn_FP_1.3C_AL_ES81

Model	Acer P/N	RO	Country	Description
AS8943G-434G64Mn	LX.PU1 02.036	EMEA	Algeria	AS8943G-434G64Mn EM W7HP64EMATDZ1 MC BROADWAY_PRO1GBCFPss_3V3J 2*2G/640/ 8L3.0/5R/CBUL_bgn_FP_1.3C_AL_ES81
AS8943G-434G64Mn	LX.PU1 02.035	EMEA	Luxembourg	AS8943G-434G64Mn W7HP64ATLU3 MC BROADWAY_PRO1GBCFPss_3V3J 2*2G/640/ 8L3.0/5R/CBUL_bgn_FP_1.3C_AL_IT41
AS8943G-434G64Mn	LX.PU1 02.034	EMEA	Holland	AS8943G-434G64Mn W7HP64ATNL1 MC BROADWAY_PRO1GBCFPss_3V3J 2*2G/640/ 8L3.0/5R/CBUL_bgn_FP_1.3C_AL_NL11
AS8943G-434G64Mn	LX.PU1 02.033	EMEA	Belgium	AS8943G-434G64Mn W7HP64ATBE1 MC BROADWAY_PRO1GBCFPss_3V3J 2*2G/640/ 8L3.0/5R/CBUL_bgn_FP_1.3C_AL_NL11
AS8943G-434G64Mn	LX.PU1 02.032	EMEA	Switzerland	AS8943G-434G64Mn W7HP64ATCH1 MC BROADWAY_PRO1GBCFPss_3V3J 2*2G/640/ 8L3.0/5R/CBUL_bgn_FP_1.3C_AL_IT41
AS8943G-434G64Mn	LX.PU1 02.031	EMEA	Latvia	AS8943G-434G64Mn W7HP64ATLV1 MC BROADWAY_PRO1GBCFPss_3V3J 2*2G/640/ 8L3.0/5R/CBUL_bgn_FP_1.3C_AL_LT11
AS8943G-434G64Mn	LX.PU1 02.030	EMEA	South Africa	AS8943G-434G64Mn EM W7HP64EMATZA1 MC BROADWAY_PRO1GBCFPss_3V3J 2*2G/640/ 8L3.0/5R/CBUL_bgn_FP_1.3C_AL_ES81
AS8943G-434G64Mn	LX.PU1 02.029	EMEA	Middle East	AS8943G-434G64Mn EM W7HP64EMATME4 MC BROADWAY_PRO1GBCFPss_3V3J 2*2G/640/ 8L3.0/5R/CBUL_bgn_FP_1.3C_AL_ES61
AS8943G-434G64Mn	LX.PU1 02.028	EMEA	Middle East	AS8943G-434G64Mn EM W7HP64EMATME2 MC BROADWAY_PRO1GBCFPss_3V3J 2*2G/640/ 8L3.0/5R/CBUL_bgn_FP_1.3C_AL_AR11
AS8943G-434G64Mn	LX.PU1 02.027	EMEA	Middle East	AS8943G-434G64Mn EM W7HP64EMATME3 MC BROADWAY_PRO1GBCFPss_3V3J 2*2G/640/ 8L3.0/5R/CBUL_bgn_FP_1.3C_AL_ES81
AS8943G-434G64Mn	LX.PU1 02.026	EMEA	Middle East	AS8943G-434G64Mn EM W7HP64EMATME6 MC BROADWAY_PRO1GBCFPss_3V3J 2*2G/640/ 8L3.0/5R/CBUL_bgn_FP_1.3C_AL_ES61
AS8943G-434G64Mn	LX.PU1 02.025	EMEA	South Africa	AS8943G-434G64Mn EM W7HP64EMATZA4 MC BROADWAY_PRO1GBCFPss_3V3J 2*2G/640/ 8L3.0/5R/CBUL_bgn_FP_1.3C_AL_ES61
AS8943G-434G64Mn	LX.PU1 02.024	EMEA	Poland	AS8943G-434G64Mn W7HP64ATPL1 MC BROADWAY_PRO1GBCFPss_3V3J 2*2G/640/ 8L3.0/5R/CBUL_bgn_FP_1.3C_AL_PL11
AS8943G-434G64Mn	LX.PU1 02.023	EMEA	Germany	AS8943G-434G64Mn W7HP64ATDE1 MC BROADWAY_PRO1GBCFPss_3V3J 2*2G/640/ 8L3.0/5R/CBUL_bgn_FP_1.3C_AL_DE11
AS8943G-434G64Mn	LX.PU1 02.022	EMEA	Baltic	AS8943G-434G64Mn W7HP64ATBC5 MC BROADWAY_PRO1GBCFPss_3V3J 2*2G/640/ 8L3.0/5R/CBUL_bgn_FP_1.3C_AL_LT11
AS8943G-434G64Mn	LX.PU1 02.021	EMEA	Latvia	AS8943G-434G64Mn W7HP64ATLV1 MC BROADWAY_PRO1GBCFPss_3V3J 2*2G/640/ 8L3.0/5R/CBUL_bgn_FP_1.3C_AL_RU22
AS8943G-434G64Mn	LX.PU1 02.019	EMEA	Eastern Europe	AS8943G-434G64Mn W7HP64ATEU5 MC BROADWAY_PRO1GBCFPss_3V3J 2*2G/640/ 8L3.0/5R/CBUL_bgn_FP_1.3C_AL_PL71

Model	Acer P/N	RO	Country	Description
AS8943G-434G64Mn	LX.PU1 02.018	EMEA	UK	AS8943G-434G64Mn W7HP64ATGB1 MC BROADWAY_PRO1GBCFPss_3V3J 2*2G/640/8L3.0/5R/CBUL_bgn_FP_1.3C_AL_EN11
AS8943G-434G64Mn	LX.PU1 02.017	EMEA	Czech	AS8943G-434G64Mn W7HP64ATCZ2 MC BROADWAY_PRO1GBCFPss_3V3J 2*2G/640/8L3.0/5R/CBUL_bgn_FP_1.3C_AL_SK11
AS8943G-434G64Mn	LX.PU1 02.016	EMEA	Hungary	AS8943G-434G64Mn W7HP64ATHU1 MC BROADWAY_PRO1GBCFPss_3V3J 2*2G/640/8L3.0/5R/CBUL_bgn_FP_1.3C_AL_HU11
AS8943G-434G64Mn	LX.PU1 02.015	EMEA	Israel	AS8943G-434G64Mn W7HP64ATIL1 MC BROADWAY_PRO1GBCFPss_3V3J 2*2G/640/8L3.0/5R/CBUL_bgn_FP_1.3C_AL_HE11
AS8943G-434G64Mn	LX.PU1 02.014	EMEA	Baltic	AS8943G-434G64Mn W7HP64ATBC4 MC BROADWAY_PRO1GBCFPss_3V3J 2*2G/640/8L3.0/5R/CBUL_bgn_FP_1.3C_AL_LT11
AS8943G-434G64Mn	LX.PU1 02.013	EMEA	Cyprus	AS8943G-434G64Mn W7HP64ATCY1 MC BROADWAY_PRO1GBCFPss_3V3J 2*2G/640/8L3.0/5R/CBUL_bgn_FP_1.3C_AL_ES61
AS8943G-434G64Mn	LX.PU1 02.012	EMEA	Portugal	AS8943G-434G64Mn W7HP64ATPT1 MC BROADWAY_PRO1GBCFPss_3V3J 2*2G/640/8L3.0/5R/CBUL_bgn_FP_1.3C_AL_PT11
AS8943G-434G64Mn	LX.PU1 02.011	EMEA	Baltic	AS8943G-434G64Mn W7HP64ATBC3 MC BROADWAY_PRO1GBCFPss_3V3J 2*2G/640/8L3.0/5R/CBUL_bgn_FP_1.3C_AL_SV21
AS8943G-434G64Mn	LX.PU1 02.010	EMEA	Serbia/ Macedonia	AS8943G-434G64Mn W7HP64ATCS1 MC BROADWAY_PRO1GBCFPss_3V3J 2*2G/640/8L3.0/5R/CBUL_bgn_FP_1.3C_AL_SL11
AS8943G-434G64Mn	LX.PU1 02.009	EMEA	Denmark	AS8943G-434G64Mn W7HP64ATDK2 MC BROADWAY_PRO1GBCFPss_3V3J 2*2G/640/8L3.0/5R/CBUL_bgn_FP_1.3C_AL_ENS1
AS8943G-434G64Mn	LX.PU1 02.008	EMEA	Eastern Europe	AS8943G-434G64Mn W7HP64ATEU7 MC BROADWAY_PRO1GBCFPss_3V3J 2*2G/640/8L3.0/5R/CBUL_bgn_FP_1.3C_AL_ENQ1
AS8943G-434G64Mn	LX.PU1 02.007	EMEA	Eastern Europe	AS8943G-434G64Mn W7HP64ATEU4 MC BROADWAY_PRO1GBCFPss_3V3J 2*2G/640/8L3.0/5R/CBUL_bgn_FP_1.3C_AL_SV21
AS8943G-434G64Mn	LX.PU1 02.006	EMEA	Italy	AS8943G-434G64Mn W7HP64ATIT1 MC BROADWAY_PRO1GBCFPss_3V3J 2*2G/640/8L3.0/5R/CBUL_bgn_FP_1.3C_AL_IT11
AS8943G-434G64Mn	LX.PU1 02.005	EMEA	Spain	AS8943G-434G64Mn W7HP64ATES1 MC BROADWAY_PRO1GBCFPss_3V3J 2*2G/640/8L3.0/5R/CBUL_bgn_FP_1.3C_AL_ES51
AS8943G-434G64Mn	LX.PU1 02.003	EMEA	Austria	AS8943G-434G64Mn W7HP64ATAT1 MC BROADWAY_PRO1GBCFPss_3V3J 2*2G/640/8L3.0/5R/CBUL_bgn_FP_1.3C_AL_DE61
AS8943G-434G64Mn	LX.PU1 02.004	EMEA	Greece	AS8943G-434G64Mn W7HP64ATGR1 MC BROADWAY_PRO1GBCFPss_3V3J 2*2G/640/8L3.0/5R/CBUL_bgn_FP_1.3C_AL_EL31
AS8943G-434G64Mn	LX.PU1 02.002	EMEA	Eastern Europe	AS8943G-434G64Mn W7HP64ATEU7 MC BROADWAY_PRO1GBCFPss_3V3J 2*2G/640/8L3.0/5R/CBUL_bgn_FP_1.3C_AL_SL11

Model	Acer P/N	RO	Country	Description
AS8943G-434G64Mn	LX.PU1 02.001	EMEA	France	AS8943G-434G64Mn W7HP64ATFR1 MC BROADWAY_PRO1GBCFPss_3V3J 2*2G/640/ 8L3.0/5R/CBUL_bgn_FP_1.3C_AL_FR21
AS8943G-82161.28T Wn	S2.PU1 02.001	WW	WW	AS8943G-82161.28TWn W7HP64AWW1 MC BROADWAY_PRO1GBCFPssQ_3V3 4G+4G+4G+4G/640+640/BT/8L3.0/5R/ CBUL_bgn_FP_1.3C_AL_ES62
AS8943G-82161.28T Wn	S2.PU1 02.001	WW	WW	AS8943G-82161.28TWn W7HP64AWW1 MC BROADWAY_PRO1GBCFPssQ_3V3 4G+4G+4G+4G/640+640/BT/8L3.0/5R/ CBUL_bgn_FP_1.3C_AL_ES62
AS8943G-728G1.28T Wn	LX.PUG 02.012	EMEA	France	AS8943G-728G1.28TWn W7HP64ATFR1 MC BROADWAY_PRO1GBTCFPssQ_3D4V3J 2G+2G+2G+2G/640+640/BT/8L3.0/5R/ CBUL_bgn_DVBT_FP_1.3C_AL_R_FR21
AS8943G-728G1.28T Wn	LX.PUG 02.011	EMEA	Czech	AS8943G-728G1.28TWn W7HP64ATCZ2 MC BROADWAY_PRO1GBTCFPssQ_3D4V3J 2G+2G+2G+2G/640+640/BT/8L3.0/5R/ CBUL_bgn_DVBT_FP_1.3C_AL_R_SK11
AS8943G-721682Bn	S2.PUG 02.002	WW	WW	AS8943G-721682Bn W7HP64AWW1 MC BROADWAY_PRO1GBTCFPssQ_3D4V3J 4G+4G+4G+4G/500_L+320/BT/8L3.0/5R/ CBUL_bgn_DVBT_U/VHF_FP_1.3C_AL_RC_ES62
AS8943G-721682Bn	S2.PUG 02.002	WW	WW	AS8943G-721682Bn W7HP64AWW1 MC BROADWAY_PRO1GBTCFPssQ_3D4V3J 4G+4G+4G+4G/500_L+320/BT/8L3.0/5R/ CBUL_bgn_DVBT_U/VHF_FP_1.3C_AL_RC_ES62
AS8943G-728G1.28T Wn	LX.PUG 02.007	AAP	Australia/ New Zealand	AS8943G-728G1.28TWn W7HP64ATAU1 MC BROADWAY_PRO1GBTCFPssQ_3D4V3J 2G+2G+2G+2G/640+640/BT/8L3.0/5R/ CBUL_bgn_DVBT_U/VHF_FP_1.3C_AL_R_ES61
AS8943G-72101.28T Wn	LX.PUG 02.010	AAP	Singapore	AS8943G-72101.28TWn W7HP64ATSG1 MC BROADWAY_PRO1GBTCFPssQ_3D4V3J 4G+4G+2G/640+640/BT/8L3.0/5R/ CBUL_bgn_DVBT_U/VHF_FP_1.3C_AL_R_ZH31
AS8943G-72161.28T Wn	LX.PUG 02.009	AAP	Singapore	AS8943G-72161.28TWn W7HP64ATSG1 MC BROADWAY_PRO1GBTCFPssQ_3D4V3J 4G+4G+4G+4G/640+640/BT/8L3.0/5R/ CBUL_bgn_DVBT_U/VHF_FP_1.3C_AL_R_ZH31
AS8943G-728G1.28T Wn	LX.PUG 02.008	AAP	Singapore	AS8943G-728G1.28TWn W7HP64ATSG1 MC BROADWAY_PRO1GBTCFPssQ_3D4V3J 2*4G/ 640+640/BT/8L3.0/5R/CBUL_bgn_DVBT U/ VHF_FP_1.3C_AL_R_ZH31
AS8943G-72161.28T Wn	LX.PUG 02.003	EMEA	Spain	AS8943G-72161.28TWn W7HP64ATES1 MC BROADWAY_PRO1GBTCFPssQ_3D4V3J 4G+4G+4G+4G/640+640/BT/8L3.0/5R/ CBUL_bgn_DVBT_U/VHF_FP_1.3C_AL_R_ES51
AS8943G-728G1.28T Wn	LX.PUG 02.004	EMEA	France	AS8943G-728G1.28TWn W7HP64ATFR1 MC BROADWAY_PRO1GBTCFPssQ_3D4V3J 2G+2G+2G+2G/640+640/BT/8L3.0/5R/ CBUL_bgn_DVBT_U/VHF_FP_1.3C_AL_R_FR21

Model	Acer P/N	RO	Country	Description
AS8943G-728G1TBn	LX.PUG 02.002	EMEA	Spain	AS8943G-728G1TBn W7HP64ATES1 MC BROADWAY_PRO1GBTCFPssQ_3D4V3J 2G+2G+2G+2G/500_L+500_L/BT/8L3.0/5R/ CBUL_bgn_DVBT U/VHF_FP_1.3C_AL_R_ES51
AS8943G-728G1TMn	S2.PUG 02.001	WW	GCTWN	AS8943G-728G1TMn W7HP64AWW1 MC BROADWAY_PRO1GBTCFPssQ_3D4V3J 2G+2G+2G+2G/500_L+500_L/BT/8L3.0/5R/ CBUL_bgn_DVBT U/VHF_FP_1.3C_AL_RC_ES61
AS8943G-728G1TMn	S2.PUG 02.001	WW	GCTWN	AS8943G-728G1TMn W7HP64AWW1 MC BROADWAY_PRO1GBTCFPssQ_3D4V3J 2G+2G+2G+2G/500_L+500_L/BT/8L3.0/5R/ CBUL_bgn_DVBT U/VHF_FP_1.3C_AL_RC_ES61
AS8943G-726G64Wn	LX.PUG 02.006	AAP	Australia/ New Zealand	AS8943G-726G64Wn W7HP64ATAU1 MC BROADWAY_PRO1GBTCFPssQ_3D4V3J 2G+2G+2G/640/BT/8L3.0/5R/CBUL_bgn_DVBT U/ VHF_FP_1.3C_AL_R_ES61
AS8943G-728G1.28T Wn	LX.PUG 02.005	EMEA	Switzerland	AS8943G-728G1.28TWn W7HP64ATCH1 MC BROADWAY_PRO1GBTCFPssQ_3D4V3J 2G+2G+2G+2G/640+640/BT/8L3.0/5R/ CBUL_bgn_DVBT U/VHF_FP_1.3C_AL_R_IT41
AS8943G-728G1.14T Bn	LX.PUG 02.001	EMEA	Spain	AS8943G-728G1.14TBn W7HP64ATES1 MC BROADWAY_PRO1GBTCFPssQ_3D4V3J 2G+2G+2G+2G/500_L+640/BT/8L3.0/5R/ CBUL_bgn_DVBT U/VHF_FP_1.3C_AL_R_ES51
AS8943G-524G64Mn	S2.PTJ0 2.002	WW	WW	AS8943G-524G64Mn W7HP64AWW1 MC BROADWAY_PRO1GBTCFss_3V3J 2*2G/ 320+320/8L3.0/5R/CBUL_bgn_DVBT U/ VHF_FP_1.3C_AL_RC_ES62
AS8943G-524G64Mn	S2.PTJ0 2.002	WW	WW	AS8943G-524G64Mn W7HP64AWW1 MC BROADWAY_PRO1GBTCFss_3V3J 2*2G/ 320+320/8L3.0/5R/CBUL_bgn_DVBT U/ VHF_FP_1.3C_AL_RC_ES62
AS8943G-544G64Bn	S2.PTJ0 2.001	WW	WW	AS8943G-544G64Bn W7HP64AWW1 MC BROADWAY_PRO1GBTCFss_3V3 2*2G/320+320/ BT/8L3.0/5R/CBUL_bgn_DVBT U/ VHF_FP_1.3C_AL_RC_ES62
AS8943G-544G64Bn	S2.PTJ0 2.001	WW	WW	AS8943G-544G64Bn W7HP64AWW1 MC BROADWAY_PRO1GBTCFss_3V3 2*2G/320+320/ BT/8L3.0/5R/CBUL_bgn_DVBT U/ VHF_FP_1.3C_AL_RC_ES62
AS8943G-724G50Bn	LX.PWC 02.074	PA	USA	AS8943G-724G50Bn W7HP64ATUS1 MC MADISON_PRO1GBCFPssQ_3D4V3J 2*2G/ 500_L/BT/8L3.0/5R/ CBUL_bgn_FP_1.3C_AL_FRB1
AS8943G-82161.28T Wn	LX.PWC 02.075	EMEA	UK	AS8943G-82161.28TWn W7HP64ATGB1 MC MADISON_PRO1GBCFPssQ_3D4V3J 4G+4G+4G+4G/640+640/BT/8L3.0/5R/ CBUL_bgn_FP_1.3C_AL_R_EN11
AS8943G-724G64Mi	LX.PWC 02.066	EMEA	Russia	AS8943G-724G64Mi W7HP64RUATRU1 MC MADISON_PRO1GBCFPssQ_3D4V3J 2*2G/640/ BT/8L3.0/5R/CBUL_bgn_FP_1.3C_AL_RU11

Model	Acer P/N	RO	Country	Description
AS8943G-724G50Mn	LX.PWC 02.070	PA	USA	AS8943G-724G50Mn W7HP64ATUS1 MC MADISON_PRO1GBCFPssQ_3D4V3J 2*2G/500_L/8L3.0/5R/CBUL_bgn_FP_1.3C_AL_FRB1
AS8943G-726G1.28TBn	LX.PWC 02.073	EMEA	Holland	AS8943G-726G1.28TBn W7HP64ATNL1 MC MADISON_PRO1GBCFPssQ_3D4V3J 2G+2G+2G/640+640/BT/8L3.0/5R/CBUL_bgn_FP_1.3C_AL_NL11
AS8943G-726G1.28TBn	LX.PWC 02.072	EMEA	Luxembourg	AS8943G-726G1.28TBn W7HP64ATLU3 MC MADISON_PRO1GBCFPssQ_3D4V3J 2G+2G+2G/640+640/BT/8L3.0/5R/CBUL_bgn_FP_1.3C_AL_IT41
AS8943G-726G1.28TBn	LX.PWC 02.071	EMEA	Belgium	AS8943G-726G1.28TBn W7HP64ATBE1 MC MADISON_PRO1GBCFPssQ_3D4V3J 2G+2G+2G/640+640/BT/8L3.0/5R/CBUL_bgn_FP_1.3C_AL_NL11
AS8943G-724G64Bn	LX.PWC 02.069	EMEA	Middle East	AS8943G-724G64Bn EM W7HP64EMATMEB MC MADISON_PRO1GBCFPssQ_3D4V3J 2*2G/640/BT/8L3.0/5R/CBUL_bgn_FP_1.3C_AL_ARA1
AS8943G-724G64Wn	LX.PWC 02.068	EMEA	Middle East	AS8943G-724G64Wn EM W7HP64EMATMEB MC MADISON_PRO1GBCFPssQ_3D4V3J 2*2G/640/BT/8L3.0/5R/CBUL_bgn_FP_1.3C_AL_ARA1
AS8943G-724G64Mn	LX.PWC 02.005	EMEA	Austria	AS8943G-724G64Mn W7HP64ATAT1 MC MADISON_PRO1GBCFPssQ_3D4V3J 2*2G/640/BT/8L3.0/5R/CBUL_bgn_FP_1.3C_AL_DE61
AS8943G-82121.28TBn	S2.PWC 02.007	WW	WW	AS8943G-82121.28TBn W7HP64AWW1 MC MADISON_PRO1GBCFPssQ_3D4V3J 2G+2G+4G+4G/640+640/BT/8L3.0/5R/CBUL_bgn_FP_1.3C_AL_ES62
AS8943G-82121.28TBn	S2.PWC 02.007	WW	WW	AS8943G-82121.28TBn W7HP64AWW1 MC MADISON_PRO1GBCFPssQ_3D4V3J 2G+2G+4G+4G/640+640/BT/8L3.0/5R/CBUL_bgn_FP_1.3C_AL_ES62
AS8943G-724G64Mn	LX.PWC 02.067	EMEA	Ukraine	AS8943G-724G64Mn W7HP64RUATUK1 MC MADISON_PRO1GBCFPssQ_3D4V3J 2*2G/640/BT/8L3.0/5R/CBUL_bgn_FP_1.3C_AL_RU61
AS8943G-724G64Mn	LX.PWC 02.065	EMEA	Middle East	AS8943G-724G64Mn EM W7HP64EMATME4 MC MADISON_PRO1GBCFPssQ_3D4V3J 2*2G/640/BT/8L3.0/5R/CBUL_bgn_FP_1.3C_AL_RU61
AS8943G-724G64Mn	LX.PWC 02.064	EMEA	Middle East	AS8943G-724G64Mn EM W7HP64EMATME2 MC MADISON_PRO1GBCFPssQ_3D4V3J 2*2G/640/BT/8L3.0/5R/CBUL_bgn_FP_1.3C_AL_ES61
AS8943G-724G64Mn	LX.PWC 02.063	EMEA	South Africa	AS8943G-724G64Mn EM W7HP64EMATZA2 MC MADISON_PRO1GBCFPssQ_3D4V3J 2*2G/640/BT/8L3.0/5R/CBUL_bgn_FP_1.3C_AL_ES61
AS8943G-724G64Mn	LX.PWC 02.062	EMEA	Turkey	AS8943G-724G64Mn EM W7HP64EMATTR1 MC MADISON_PRO1GBCFPssQ_3D4V3J 2*2G/640/BT/8L3.0/5R/CBUL_bgn_FP_1.3C_AL_TR31
AS8943G-724G64Mn	LX.PWC 02.061	EMEA	Germany	AS8943G-724G64Mn W7HP64ATDE1 MC MADISON_PRO1GBCFPssQ_3D4V3J 2*2G/640/BT/8L3.0/5R/CBUL_bgn_FP_1.3C_AL_DE11

Model	Acer P/N	RO	Country	Description
AS8943G-724G64Mn	LX.PWC 02.059	EMEA	Poland	AS8943G-724G64Mn W7HP64ATPL1 MC MADISON_PRO1GBCFPssQ_3D4V3J 2*2G/640/ BT/8L3.0/5R/CBUL_bgn_FP_1.3C_AL_PL11
AS8943G-724G64Mn	LX.PWC 02.058	EMEA	Baltic	AS8943G-724G64Mn W7HP64ATBC5 MC MADISON_PRO1GBCFPssQ_3D4V3J 2*2G/640/ BT/8L3.0/5R/CBUL_bgn_FP_1.3C_AL_LT11
AS8943G-724G64Mn	LX.PWC 02.056	EMEA	Holland	AS8943G-724G64Mn W7HP64ATNL1 MC MADISON_PRO1GBCFPssQ_3D4V3J 2*2G/640/ BT/8L3.0/5R/CBUL_bgn_FP_1.3C_AL_NL11
AS8943G-724G64Mn	LX.PWC 02.055	EMEA	Belgium	AS8943G-724G64Mn W7HP64ATBE1 MC MADISON_PRO1GBCFPssQ_3D4V3J 2*2G/640/ BT/8L3.0/5R/CBUL_bgn_FP_1.3C_AL_NL11
AS8943G-724G64Mn	LX.PWC 02.051	EMEA	Middle East	AS8943G-724G64Mn EM W7HP64EMATMEB MC MADISON_PRO1GBCFPssQ_3D4V3J 2*2G/640/ BT/8L3.0/5R/CBUL_bgn_FP_1.3C_AL_ARA1
AS8943G-724G64Mn	LX.PWC 02.050	EMEA	Middle East	AS8943G-724G64Mn EM W7HP64EMATME2 MC MADISON_PRO1GBCFPssQ_3D4V3J 2*2G/640/ BT/8L3.0/5R/CBUL_bgn_FP_1.3C_AL_AR21
AS8943G-724G64Mn	LX.PWC 02.049	EMEA	South Africa	AS8943G-724G64Mn EM W7HP64EMATZA5 MC MADISON_PRO1GBCFPssQ_3D4V3J 2*2G/640/ BT/8L3.0/5R/CBUL_bgn_FP_1.3C_AL_ES61
AS8943G-724G64Mn	LX.PWC 02.048	EMEA	Middle East	AS8943G-724G64Mn EM W7HP64EMATME9 MC MADISON_PRO1GBCFPssQ_3D4V3J 2*2G/640/ BT/8L3.0/5R/CBUL_bgn_FP_1.3C_AL_ES81
AS8943G-724G64Mn	LX.PWC 02.047	EMEA	Algeria	AS8943G-724G64Mn EM W7HP64EMATDZ1 MC MADISON_PRO1GBCFPssQ_3D4V3J 2*2G/640/ BT/8L3.0/5R/CBUL_bgn_FP_1.3C_AL_ES81
AS8943G-724G64Mn	LX.PWC 02.046	EMEA	South Africa	AS8943G-724G64Mn EM W7HP64EMATZA1 MC MADISON_PRO1GBCFPssQ_3D4V3J 2*2G/640/ BT/8L3.0/5R/CBUL_bgn_FP_1.3C_AL_ES81
AS8943G-724G64Mn	LX.PWC 02.045	EMEA	Switzerland	AS8943G-724G64Mn W7HP64ATCH1 MC MADISON_PRO1GBCFPssQ_3D4V3J 2*2G/640/ BT/8L3.0/5R/CBUL_bgn_FP_1.3C_AL_IT41
AS8943G-724G64Mn	LX.PWC 02.044	EMEA	Luxembourg	AS8943G-724G64Mn W7HP64ATLU3 MC MADISON_PRO1GBCFPssQ_3D4V3J 2*2G/640/ BT/8L3.0/5R/CBUL_bgn_FP_1.3C_AL_IT41
AS8943G-724G64Mn	LX.PWC 02.043	EMEA	Latvia	AS8943G-724G64Mn W7HP64ATLV1 MC MADISON_PRO1GBCFPssQ_3D4V3J 2*2G/640/ BT/8L3.0/5R/CBUL_bgn_FP_1.3C_AL_LT11
AS8943G-724G64Mn	LX.PWC 02.042	EMEA	Latvia	AS8943G-724G64Mn W7HP64ATLV1 MC MADISON_PRO1GBCFPssQ_3D4V3J 2*2G/640/ BT/8L3.0/5R/CBUL_bgn_FP_1.3C_AL_RU22
AS8943G-724G64Mn	LX.PWC 02.041	EMEA	UK	AS8943G-724G64Mn W7HP64ATGB1 MC MADISON_PRO1GBCFPssQ_3D4V3J 2*2G/640/ BT/8L3.0/5R/CBUL_bgn_FP_1.3C_AL_EN11
AS8943G-724G64Mn	LX.PWC 02.040	EMEA	Eastern Europe	AS8943G-724G64Mn W7HP64ATEU5 MC MADISON_PRO1GBCFPssQ_3D4V3J 2*2G/640/ BT/8L3.0/5R/CBUL_bgn_FP_1.3C_AL_RO11
AS8943G-724G64Mn	LX.PWC 02.037	EMEA	Eastern Europe	AS8943G-724G64Mn W7HP64ATEU5 MC MADISON_PRO1GBCFPssQ_3D4V3J 2*2G/640/ BT/8L3.0/5R/CBUL_bgn_FP_1.3C_AL_PL71

Model	Acer P/N	RO	Country	Description
AS8943G-724G64Mn	LX.PWC 02.035	EMEA	Middle East	AS8943G-724G64Mn EM W7HP64EMATME4 MC MADISON_PRO1GBCFPssQ_3D4V3J 2*2G/640/BT/8L3.0/5R/CBUL_bgn_FP_1.3C_AL_ES61
AS8943G-724G64Mn	LX.PWC 02.034	EMEA	Middle East	AS8943G-724G64Mn EM W7HP64EMATME2 MC MADISON_PRO1GBCFPssQ_3D4V3J 2*2G/640/BT/8L3.0/5R/CBUL_bgn_FP_1.3C_AL_AR11
AS8943G-724G64Mn	LX.PWC 02.033	EMEA	Middle East	AS8943G-724G64Mn EM W7HP64EMATME3 MC MADISON_PRO1GBCFPssQ_3D4V3J 2*2G/640/BT/8L3.0/5R/CBUL_bgn_FP_1.3C_AL_ES81
AS8943G-724G64Mn	LX.PWC 02.032	EMEA	Middle East	AS8943G-724G64Mn EM W7HP64EMATME6 MC MADISON_PRO1GBCFPssQ_3D4V3J 2*2G/640/BT/8L3.0/5R/CBUL_bgn_FP_1.3C_AL_ES61
AS8943G-724G64Mn	LX.PWC 02.031	EMEA	South Africa	AS8943G-724G64Mn EM W7HP64EMATZA4 MC MADISON_PRO1GBCFPssQ_3D4V3J 2*2G/640/BT/8L3.0/5R/CBUL_bgn_FP_1.3C_AL_ES61
AS8943G-724G64Mn	LX.PWC 02.030	EMEA	Czech	AS8943G-724G64Mn W7HP64ATCZ2 MC MADISON_PRO1GBCFPssQ_3D4V3J 2*2G/640/BT/8L3.0/5R/CBUL_bgn_FP_1.3C_AL_SK11
AS8943G-724G64Mn	LX.PWC 02.029	EMEA	Hungary	AS8943G-724G64Mn W7HP64ATHU1 MC MADISON_PRO1GBCFPssQ_3D4V3J 2*2G/640/BT/8L3.0/5R/CBUL_bgn_FP_1.3C_AL_HU11
AS8943G-724G64Mn	LX.PWC 02.028	EMEA	Israel	AS8943G-724G64Mn W7HP64ATIL1 MC MADISON_PRO1GBCFPssQ_3D4V3J 2*2G/640/BT/8L3.0/5R/CBUL_bgn_FP_1.3C_AL_HE11
AS8943G-724G64Mn	LX.PWC 02.027	EMEA	Baltic	AS8943G-724G64Mn W7HP64ATBC4 MC MADISON_PRO1GBCFPssQ_3D4V3J 2*2G/640/BT/8L3.0/5R/CBUL_bgn_FP_1.3C_AL_LT11
AS8943G-724G64Mn	LX.PWC 02.026	EMEA	Portugal	AS8943G-724G64Mn W7HP64ATPT1 MC MADISON_PRO1GBCFPssQ_3D4V3J 2*2G/640/BT/8L3.0/5R/CBUL_bgn_FP_1.3C_AL_PT11
AS8943G-724G64Mn	LX.PWC 02.025	EMEA	Cyprus	AS8943G-724G64Mn W7HP64ATCY1 MC MADISON_PRO1GBCFPssQ_3D4V3J 2*2G/640/BT/8L3.0/5R/CBUL_bgn_FP_1.3C_AL_ES61
AS8943G-724G64Mn	LX.PWC 02.024	EMEA	Baltic	AS8943G-724G64Mn W7HP64ATBC3 MC MADISON_PRO1GBCFPssQ_3D4V3J 2*2G/640/BT/8L3.0/5R/CBUL_bgn_FP_1.3C_AL_SV21
AS8943G-724G64Mn	LX.PWC 02.019	EMEA	Serbia/ Macedonia	AS8943G-724G64Mn W7HP64ATCS1 MC MADISON_PRO1GBCFPssQ_3D4V3J 2*2G/640/BT/8L3.0/5R/CBUL_bgn_FP_1.3C_AL_SL11
AS8943G-724G64Mn	LX.PWC 02.018	EMEA	Italy	AS8943G-724G64Mn W7HP64ATIT1 MC MADISON_PRO1GBCFPssQ_3D4V3J 2*2G/640/BT/8L3.0/5R/CBUL_bgn_FP_1.3C_AL_IT11
AS8943G-724G64Mn	LX.PWC 02.015	EMEA	Spain	AS8943G-724G64Mn W7HP64ATES1 MC MADISON_PRO1GBCFPssQ_3D4V3J 2*2G/640/BT/8L3.0/5R/CBUL_bgn_FP_1.3C_AL_ES51
AS8943G-724G64Mn	LX.PWC 02.012	EMEA	Denmark	AS8943G-724G64Mn W7HP64ATDK2 MC MADISON_PRO1GBCFPssQ_3D4V3J 2*2G/640/BT/8L3.0/5R/CBUL_bgn_FP_1.3C_AL_ENS1
AS8943G-724G64Mn	LX.PWC 02.011	EMEA	Eastern Europe	AS8943G-724G64Mn W7HP64ATEU7 MC MADISON_PRO1GBCFPssQ_3D4V3J 2*2G/640/BT/8L3.0/5R/CBUL_bgn_FP_1.3C_AL_ENQ1

Model	Acer P/N	RO	Country	Description
AS8943G-724G64Mn	LX.PWC 02.008	EMEA	Eastern Europe	AS8943G-724G64Mn W7HP64ATEU4 MC MADISON_PRO1GBCFPssQ_3D4V3J 2*2G/640/BT/8L3.0/5R/CBUL_bgn_FP_1.3C_AL_SV21
AS8943G-724G64Mn	LX.PWC 02.007	EMEA	Greece	AS8943G-724G64Mn W7HP64ATGR1 MC MADISON_PRO1GBCFPssQ_3D4V3J 2*2G/640/BT/8L3.0/5R/CBUL_bgn_FP_1.3C_AL_EL31
AS8943G-724G64Mn	LX.PWC 02.004	EMEA	France	AS8943G-724G64Mn W7HP64ATFR1 MC MADISON_PRO1GBCFPssQ_3D4V3J 2*2G/640/BT/8L3.0/5R/CBUL_bgn_FP_1.3C_AL_FR21
AS8943G-724G64Mn	LX.PWC 02.001	EMEA	Eastern Europe	AS8943G-724G64Mn W7HP64ATEU7 MC MADISON_PRO1GBCFPssQ_3D4V3J 2*2G/640/BT/8L3.0/5R/CBUL_bgn_FP_1.3C_AL_SL11
AS8943G-354G50Mn	LX.PUJ0 2.059	EMEA	France	AS8943G-354G50Mn W7HP64ATFR1 MC MADISON_PRO1GBCFPss_3V3J 2*2G/500_L/BT/8L3.0/5R/CBUL_bgn_FP_1.3C_AL_FR21
AS8943G-434G1TBn	LX.PUJ0 2.041	EMEA	Latvia	AS8943G-434G1TBn W7HP64ATLV1 MC MADISON_PRO1GBCFPss_3V3J 2*2G/500_L+500_L/BT/8L3.0/5R/CBUL_bgn_FP_1.3C_AL_RU22
AS8943G-333G32Mn	LX.PUJ0 2.058	EMEA	Turkey	AS8943G-333G32Mn EM W7HP64EMATTR1 MC MADISON_PRO1GBCFPss_3V3J 2G+1G/320/BT/8L3.0/5R/CBUL_bgn_FP_1.3C_AL_R_TR31
AS8943G-526G64Mn	LX.PUJ0 2.057	EMEA	Turkey	AS8943G-526G64Mn EM W7HP64EMATTR1 MC MADISON_PRO1GBCFPss_3V3J 4G+2G/320+320/BT/8L3.0/5R/CBUL_bgn_FP_1.3C_AL_R_TR31
AS8943G-434G50Mn	LX.PUJ0 2.056	EMEA	Turkey	AS8943G-434G50Mn EM W7HP64EMATTR1 MC MADISON_PRO1GBCFPss_3V3J 2*2G/500_L/BT/8L3.0/5R/CBUL_bgn_FP_1.3C_AL_R_TR31
AS8943G-434G1TMn	LX.PUJ0 2.054	EMEA	Holland	AS8943G-434G1TMn W7HP64ATNL1 MC MADISON_PRO1GBCFPss_3V3J 2*2G/500_L+500_L/BT/8L3.0/5R/CBUL_bgn_FP_1.3C_AL_NL11
AS8943G-434G1TMn	LX.PUJ0 2.055	EMEA	Belgium	AS8943G-434G1TMn W7HP64ATBE1 MC MADISON_PRO1GBCFPss_3V3J 2*2G/500_L+500_L/BT/8L3.0/5R/CBUL_bgn_FP_1.3C_AL_NL11
AS8943G-434G1TMn	LX.PUJ0 2.053	EMEA	Luxembourg	AS8943G-434G1TMn W7HP64ATLU3 MC MADISON_PRO1GBCFPss_3V3J 2*2G/500_L+500_L/BT/8L3.0/5R/CBUL_bgn_FP_1.3C_AL_IT41
AS8943G-334G50Mi	LX.PUJ0 2.006	EMEA	Russia	AS8943G-334G50Mi W7HP64RUATRU1 MC MADISON_PRO1GBCFPss_3V3J 2*2G/500_L/8L3.0/5R/CBUL_bg_FP_1.3C_AL_RU11
AS8943G-434G1TBn	LX.PUJ0 2.052	EMEA	Ukraine	AS8943G-434G1TBn W7HP64RUATUK1 MC MADISON_PRO1GBCFPss_3V3J 2*2G/500_L+500_L/BT/8L3.0/5R/CBUL_bgn_FP_1.3C_AL_RU61
AS8943G-434G1TBi	LX.PUJ0 2.051	EMEA	Russia	AS8943G-434G1TBi W7HP64RUATRU1 MC MADISON_PRO1GBCFPss_3V3J 2*2G/500_L+500_L/BT/8L3.0/5R/CBUL_bg_FP_1.3C_AL_RU11

Model	Acer P/N	RO	Country	Description
AS8943G-434G1TBn	LX.PUJ0 2.050	EMEA	Middle East	AS8943G-434G1TBn EM W7HP64EMATME4 MC MADISON_PRO1GBCFPss_3V3J 2*2G/ 500_L+500_L/BT/8L3.0/5R/ CBUL_bgn_FP_1.3C_AL_RU61
AS8943G-434G1TBn	LX.PUJ0 2.049	EMEA	Germany	AS8943G-434G1TBn W7HP64ATDE1 MC MADISON_PRO1GBCFPss_3V3J 2*2G/ 500_L+500_L/BT/8L3.0/5R/ CBUL_bgn_FP_1.3C_AL_DE11
AS8943G-434G1TBn	LX.PUJ0 2.048	EMEA	Poland	AS8943G-434G1TBn W7HP64ATPL1 MC MADISON_PRO1GBCFPss_3V3J 2*2G/ 500_L+500_L/BT/8L3.0/5R/ CBUL_bgn_FP_1.3C_AL_PL11
AS8943G-434G1TBn	LX.PUJ0 2.047	EMEA	Baltic	AS8943G-434G1TBn W7HP64ATBC5 MC MADISON_PRO1GBCFPss_3V3J 2*2G/ 500_L+500_L/BT/8L3.0/5R/ CBUL_bgn_FP_1.3C_AL_LT11
AS8943G-434G1TBn	LX.PUJ0 2.045	EMEA	Belgium	AS8943G-434G1TBn W7HP64ATBE1 MC MADISON_PRO1GBCFPss_3V3J 2*2G/ 500_L+500_L/BT/8L3.0/5R/ CBUL_bgn_FP_1.3C_AL_NL11
AS8943G-434G1TBn	LX.PUJ0 2.046	EMEA	Holland	AS8943G-434G1TBn W7HP64ATNL1 MC MADISON_PRO1GBCFPss_3V3J 2*2G/ 500_L+500_L/BT/8L3.0/5R/ CBUL_bgn_FP_1.3C_AL_NL11
AS8943G-434G1TBn	LX.PUJ0 2.044	EMEA	Switzerland	AS8943G-434G1TBn W7HP64ATCH1 MC MADISON_PRO1GBCFPss_3V3J 2*2G/ 500_L+500_L/BT/8L3.0/5R/ CBUL_bgn_FP_1.3C_AL_IT41
AS8943G-434G1TBn	LX.PUJ0 2.043	EMEA	Luxembourg	AS8943G-434G1TBn W7HP64ATLU3 MC MADISON_PRO1GBCFPss_3V3J 2*2G/ 500_L+500_L/BT/8L3.0/5R/ CBUL_bgn_FP_1.3C_AL_IT41
AS8943G-434G1TBn	LX.PUJ0 2.042	EMEA	Latvia	AS8943G-434G1TBn W7HP64ATLV1 MC MADISON_PRO1GBCFPss_3V3J 2*2G/ 500_L+500_L/BT/8L3.0/5R/ CBUL_bgn_FP_1.3C_AL_LT11
AS8943G-434G1TBn	LX.PUJ0 2.040	EMEA	UK	AS8943G-434G1TBn W7HP64ATGB1 MC MADISON_PRO1GBCFPss_3V3J 2*2G/ 500_L+500_L/BT/8L3.0/5R/ CBUL_bgn_FP_1.3C_AL_EN11
AS8943G-434G1TBn	LX.PUJ0 2.039	EMEA	Eastern Europe	AS8943G-434G1TBn W7HP64ATEU5 MC MADISON_PRO1GBCFPss_3V3J 2*2G/ 500_L+500_L/BT/8L3.0/5R/ CBUL_bgn_FP_1.3C_AL_RO11
AS8943G-434G1TBn	LX.PUJ0 2.038	EMEA	Eastern Europe	AS8943G-434G1TBn W7HP64ATEU5 MC MADISON_PRO1GBCFPss_3V3J 2*2G/ 500_L+500_L/BT/8L3.0/5R/ CBUL_bgn_FP_1.3C_AL_PL71
AS8943G-434G1TBn	LX.PUJ0 2.037	EMEA	Czech	AS8943G-434G1TBn W7HP64ATCZ2 MC MADISON_PRO1GBCFPss_3V3J 2*2G/ 500_L+500_L/BT/8L3.0/5R/ CBUL_bgn_FP_1.3C_AL_SK11

Model	Acer P/N	RO	Country	Description
AS8943G-434G1TBn	LX.PUJ0 2.036	EMEA	Hungary	AS8943G-434G1TBn W7HP64ATHU1 MC MADISON_PRO1GBCFPss_3V3J 2*2G/ 500_L+500_L/BT/8L3.0/5R/ CBUL_bgn_FP_1.3C_AL_HU11
AS8943G-434G1TBn	LX.PUJ0 2.035	EMEA	Israel	AS8943G-434G1TBn W7HP64ATIL1 MC MADISON_PRO1GBCFPss_3V3J 2*2G/ 500_L+500_L/BT/8L3.0/5R/ CBUL_bgn_FP_1.3C_AL_HE11
AS8943G-434G1TBn	LX.PUJ0 2.034	EMEA	Middle East	AS8943G-434G1TBn EM W7HP64EMATME2 MC MADISON_PRO1GBCFPss_3V3J 2*2G/ 500_L+500_L/BT/8L3.0/5R/ CBUL_bgn_FP_1.3C_AL_ES61
AS8943G-434G1TBn	LX.PUJ0 2.033	EMEA	South Africa	AS8943G-434G1TBn EM W7HP64EMATZA2 MC MADISON_PRO1GBCFPss_3V3J 2*2G/ 500_L+500_L/BT/8L3.0/5R/ CBUL_bgn_FP_1.3C_AL_ES61
AS8943G-434G1TBn	LX.PUJ0 2.032	EMEA	Turkey	AS8943G-434G1TBn EM W7HP64EMATTR1 MC MADISON_PRO1GBCFPss_3V3J 2*2G/ 500_L+500_L/BT/8L3.0/5R/ CBUL_bgn_FP_1.3C_AL_TR31
AS8943G-434G1TBn	LX.PUJ0 2.031	EMEA	Middle East	AS8943G-434G1TBn EM W7HP64EMATMEB MC MADISON_PRO1GBCFPss_3V3J 2*2G/ 500_L+500_L/BT/8L3.0/5R/ CBUL_bgn_FP_1.3C_AL_ARA1
AS8943G-434G1TBn	LX.PUJ0 2.030	EMEA	Middle East	AS8943G-434G1TBn EM W7HP64EMATME2 MC MADISON_PRO1GBCFPss_3V3J 2*2G/ 500_L+500_L/BT/8L3.0/5R/ CBUL_bgn_FP_1.3C_AL_AR21
AS8943G-434G1TBn	LX.PUJ0 2.029	EMEA	South Africa	AS8943G-434G1TBn EM W7HP64EMATZA5 MC MADISON_PRO1GBCFPss_3V3J 2*2G/ 500_L+500_L/BT/8L3.0/5R/ CBUL_bgn_FP_1.3C_AL_ES61
AS8943G-434G1TBn	LX.PUJ0 2.028	EMEA	Middle East	AS8943G-434G1TBn EM W7HP64EMATME9 MC MADISON_PRO1GBCFPss_3V3J 2*2G/ 500_L+500_L/BT/8L3.0/5R/ CBUL_bgn_FP_1.3C_AL_ES81
AS8943G-434G1TBn	LX.PUJ0 2.027	EMEA	Algeria	AS8943G-434G1TBn EM W7HP64EMATDZ1 MC MADISON_PRO1GBCFPss_3V3J 2*2G/ 500_L+500_L/BT/8L3.0/5R/ CBUL_bgn_FP_1.3C_AL_ES81
AS8943G-434G1TBn	LX.PUJ0 2.026	EMEA	South Africa	AS8943G-434G1TBn EM W7HP64EMATZA1 MC MADISON_PRO1GBCFPss_3V3J 2*2G/ 500_L+500_L/BT/8L3.0/5R/ CBUL_bgn_FP_1.3C_AL_ES81
AS8943G-434G1TBn	LX.PUJ0 2.025	EMEA	Middle East	AS8943G-434G1TBn EM W7HP64EMATME4 MC MADISON_PRO1GBCFPss_3V3J 2*2G/ 500_L+500_L/BT/8L3.0/5R/ CBUL_bgn_FP_1.3C_AL_ES61
AS8943G-434G1TBn	LX.PUJ0 2.024	EMEA	Middle East	AS8943G-434G1TBn EM W7HP64EMATME2 MC MADISON_PRO1GBCFPss_3V3J 2*2G/ 500_L+500_L/BT/8L3.0/5R/ CBUL_bgn_FP_1.3C_AL_AR11

Model	Acer P/N	RO	Country	Description
AS8943G-434G1TBn	LX.PUJ0 2.023	EMEA	Middle East	AS8943G-434G1TBn EM W7HP64EMATME3 MC MADISON_PRO1GBCFPss_3V3J 2*2G/ 500_L+500_L/BT/8L3.0/5R/ CBUL_bgn_FP_1.3C_AL_ES81
AS8943G-434G1TBn	LX.PUJ0 2.022	EMEA	Middle East	AS8943G-434G1TBn EM W7HP64EMATME6 MC MADISON_PRO1GBCFPss_3V3J 2*2G/ 500_L+500_L/BT/8L3.0/5R/ CBUL_bgn_FP_1.3C_AL_ES61
AS8943G-434G1TBn	LX.PUJ0 2.021	EMEA	South Africa	AS8943G-434G1TBn EM W7HP64EMATZA4 MC MADISON_PRO1GBCFPss_3V3J 2*2G/ 500_L+500_L/BT/8L3.0/5R/ CBUL_bgn_FP_1.3C_AL_ES61
AS8943G-434G1TBn	LX.PUJ0 2.020	EMEA	Baltic	AS8943G-434G1TBn W7HP64ATBC4 MC MADISON_PRO1GBCFPss_3V3J 2*2G/ 500_L+500_L/BT/8L3.0/5R/ CBUL_bgn_FP_1.3C_AL_LT11
AS8943G-434G1TBn	LX.PUJ0 2.019	EMEA	Portugal	AS8943G-434G1TBn W7HP64ATPT1 MC MADISON_PRO1GBCFPss_3V3J 2*2G/ 500_L+500_L/BT/8L3.0/5R/ CBUL_bgn_FP_1.3C_AL_PT11
AS8943G-434G1TBn	LX.PUJ0 2.018	EMEA	Cyprus	AS8943G-434G1TBn W7HP64ATCY1 MC MADISON_PRO1GBCFPss_3V3J 2*2G/ 500_L+500_L/BT/8L3.0/5R/ CBUL_bgn_FP_1.3C_AL_ES61
AS8943G-434G1TBn	LX.PUJ0 2.017	EMEA	Baltic	AS8943G-434G1TBn W7HP64ATBC3 MC MADISON_PRO1GBCFPss_3V3J 2*2G/ 500_L+500_L/BT/8L3.0/5R/ CBUL_bgn_FP_1.3C_AL_SV21
AS8943G-434G1TBn	LX.PUJ0 2.016	EMEA	Serbia/ Macedonia	AS8943G-434G1TBn W7HP64ATCS1 MC MADISON_PRO1GBCFPss_3V3J 2*2G/ 500_L+500_L/BT/8L3.0/5R/ CBUL_bgn_FP_1.3C_AL_SL11
AS8943G-434G1TBn	LX.PUJ0 2.015	EMEA	Italy	AS8943G-434G1TBn W7HP64ATIT1 MC MADISON_PRO1GBCFPss_3V3J 2*2G/ 500_L+500_L/BT/8L3.0/5R/ CBUL_bgn_FP_1.3C_AL_IT11
AS8943G-434G1TBn	LX.PUJ0 2.014	EMEA	Spain	AS8943G-434G1TBn W7HP64ATES1 MC MADISON_PRO1GBCFPss_3V3J 2*2G/ 500_L+500_L/BT/8L3.0/5R/ CBUL_bgn_FP_1.3C_AL_ES51
AS8943G-434G1TBn	LX.PUJ0 2.013	EMEA	Denmark	AS8943G-434G1TBn W7HP64ATDK2 MC MADISON_PRO1GBCFPss_3V3J 2*2G/ 500_L+500_L/BT/8L3.0/5R/ CBUL_bgn_FP_1.3C_AL_ENS1
AS8943G-434G1TBn	LX.PUJ0 2.012	EMEA	Eastern Europe	AS8943G-434G1TBn W7HP64ATEU7 MC MADISON_PRO1GBCFPss_3V3J 2*2G/ 500_L+500_L/BT/8L3.0/5R/ CBUL_bgn_FP_1.3C_AL_ENQ1
AS8943G-434G1TBn	LX.PUJ0 2.011	EMEA	Eastern Europe	AS8943G-434G1TBn W7HP64ATEU4 MC MADISON_PRO1GBCFPss_3V3J 2*2G/ 500_L+500_L/BT/8L3.0/5R/ CBUL_bgn_FP_1.3C_AL_SV21

Model	Acer P/N	RO	Country	Description
AS8943G-434G1TBn	LX.PUJ0 2.010	EMEA	Greece	AS8943G-434G1TBn W7HP64ATGR1 MC MADISON_PRO1GBCFPss_3V3J 2*2G/500_L+500_L/BT/8L3.0/5R/CBUL_bgn_FP_1.3C_AL_EL31
AS8943G-434G1TBn	LX.PUJ0 2.009	EMEA	Austria	AS8943G-434G1TBn W7HP64ATAT1 MC MADISON_PRO1GBCFPss_3V3J 2*2G/500_L+500_L/BT/8L3.0/5R/CBUL_bgn_FP_1.3C_AL_DE61
AS8943G-434G1TBn	LX.PUJ0 2.008	EMEA	France	AS8943G-434G1TBn W7HP64ATFR1 MC MADISON_PRO1GBCFPss_3V3J 2*2G/500_L+500_L/BT/8L3.0/5R/CBUL_bgn_FP_1.3C_AL_FR21
AS8943G-434G1TBn	LX.PUJ0 2.007	EMEA	Eastern Europe	AS8943G-434G1TBn W7HP64ATEU7 MC MADISON_PRO1GBCFPss_3V3J 2*2G/500_L+500_L/BT/8L3.0/5R/CBUL_bgn_FP_1.3C_AL_SL11
AS8943G-434G1TMn	LX.PUJ0 2.003	EMEA	France	AS8943G-434G1TMn W7HP64ATFR1 MC MADISON_PRO1GBCFPss_3V3J 2*2G/500_L+500_L/BT/8L3.0/5R/CBUL_bgn_FP_1.3C_AL_FR21
AS8943G-334G50Mn	LX.PUJ0 2.004	EMEA	France	AS8943G-334G50Mn W7HP64ATFR1 MC MADISON_PRO1GBCFPss_3V3J 2*2G/500_L/BT/8L3.0/5R/CBUL_bgn_FP_1.3C_AL_FR21
AS8943G-626G1TWn	LX.PUJ0 2.005	EMEA	Turkey	AS8943G-626G1TWn EM W7HP64EMATTR1 MC MADISON_PRO1GBCFPss_3V3J 4G+2G/500_L+500_L/BT/8L3.0/5R/CBUL_bgn_FP_1.3C_AL_R_TR31
AS8943G-434G64Mn	LX.PUJ0 2.002	EMEA	Spain	AS8943G-434G64Mn W7HP64ATES1 MC MADISON_PRO1GBCFPss_3V3J 2*2G/640/8L3.0/5R/CBUL_bgn_FP_1.3C_AL_ES51
AS8943G-434G50Mn	LX.PUJ0 2.001	EMEA	Spain	AS8943G-434G50Mn W7HP64ATES1 MC MADISON_PRO1GBCFPss_3V3J 2*2G/500_L/8L3.0/5R/CBUL_bgn_FP_1.3C_AL_ES51
AS8943G-544G1TMn	S2.PUJ0 2.001	WW	WW	AS8943G-544G1TMn W7HP64AWW1 MC MADISON_PRO1GBCFPss_3V3 2*2G/500_L+500_L/BT/8L3.0/5R/CBUL_bgn_FP_1.3C_AL_ES62
AS8943G-544G1TMn	S2.PUJ0 2.001	WW	WW	AS8943G-544G1TMn W7HP64AWW1 MC MADISON_PRO1GBCFPss_3V3 2*2G/500_L+500_L/BT/8L3.0/5R/CBUL_bgn_FP_1.3C_AL_ES62
AS8943G-434G32Mn	LX.PU2 02.006	EMEA	Austria	AS8943G-434G32Mn W7HP64ATAT1 MC MADISON_PRO1GBCFPss_3V3J 2*2G/320/8L3.0/5R/CBUL_bgn_FP_1.3C_AL_DE61
AS8943G-334G64Mn	LX.PU2 02.003	EMEA	Luxembourg	AS8943G-334G64Mn W7HP64ATLU3 MC MADISON_PRO1GBCFPss_3V3J 2*2G/640/BT/8L3.0/5R/CBUL_bgn_FP_1.3C_AL_IT41
AS8943G-334G64Mn	LX.PU2 02.005	EMEA	Belgium	AS8943G-334G64Mn W7HP64ATBE1 MC MADISON_PRO1GBCFPss_3V3J 2*2G/640/BT/8L3.0/5R/CBUL_bgn_FP_1.3C_AL_NL11
AS8943G-334G64Mn	LX.PU2 02.004	EMEA	Holland	AS8943G-334G64Mn W7HP64ATNL1 MC MADISON_PRO1GBCFPss_3V3J 2*2G/640/BT/8L3.0/5R/CBUL_bgn_FP_1.3C_AL_NL11

Model	Acer P/N	RO	Country	Description
AS8943G-434G32Mn	LX.PU2 02.002	EMEA	Germany	AS8943G-434G32Mn W7HP64ATDE1 MC MADISON_PRO1GBCFss_3V3J 2*2G/320/8L3.0/5R/CBUL_bgn_FP_1.3C_AL_DE11
AS8943G-624G64Mn	LX.PU2 02.001	CHIN A	China	AS8943G-624G64Mn W7HP64SCATCN1 MC MADISON_PRO1GBCFss_3V3J 2*2G/640/BT/8L3.0/5R/CBUL_bgn_FP_1.3C_AL_SC14
AS8943G-628G1TMn	S2.PU2 02.001	WW	WW	AS8943G-628G1TMn W7HP64AWW1 MC MADISON_PRO1GBCFss_3V3 2*4G/500_L+500_L/BT/8L3.0/5R/CBUL_bgn_FP_1.3C_AL_ES62
AS8943G-628G1TMn	S2.PU2 02.001	WW	WW	AS8943G-628G1TMn W7HP64AWW1 MC MADISON_PRO1GBCFss_3V3 2*4G/500_L+500_L/BT/8L3.0/5R/CBUL_bgn_FP_1.3C_AL_ES62
AS8943G-332G57Mn	S2.PTL0 2.001	WW	WW	AS8943G-332G57Mn W7HP64AWW1 MC MADISON_PRO1GBTCFPss_3V3 2*1G/320+250/BT/8L3.0/5R/CBUL_bgn_DVBT U/VHF_FP_1.3C_AL_RC_ES62
AS8943G-332G57Mn	S2.PTL0 2.001	WW	WW	AS8943G-332G57Mn W7HP64AWW1 MC MADISON_PRO1GBTCFPss_3V3 2*1G/320+250/BT/8L3.0/5R/CBUL_bgn_DVBT U/VHF_FP_1.3C_AL_RC_ES62
AS8943G-432G82Mn	S2.PTL0 2.003	WW	WW	AS8943G-432G82Mn W7HP64AWW1 MC MADISON_PRO1GBTCFPss_3V3J 2*1G/500_L+320/BT/8L3.0/5R/CBUL_bgn_DVBT U/VHF_FP_1.3C_AL_RC_ES62
AS8943G-432G82Mn	S2.PTL0 2.003	WW	WW	AS8943G-432G82Mn W7HP64AWW1 MC MADISON_PRO1GBTCFPss_3V3J 2*1G/500_L+320/BT/8L3.0/5R/CBUL_bgn_DVBT U/VHF_FP_1.3C_AL_RC_ES62
AS8943G-524G64Mn	S2.PTL0 2.002	WW	WW	AS8943G-524G64Mn W7HP64AWW1 MC MADISON_PRO1GBTCFPss_3V3J 2*2G/320+320/BT/8L3.0/5R/CBUL_bgn_DVBT U/VHF_FP_1.3C_AL_RC_ES62
AS8943G-524G64Mn	S2.PTL0 2.002	WW	WW	AS8943G-524G64Mn W7HP64AWW1 MC MADISON_PRO1GBTCFPss_3V3J 2*2G/320+320/BT/8L3.0/5R/CBUL_bgn_DVBT U/VHF_FP_1.3C_AL_RC_ES62

Model	Country	Acer P/N	BOM Name	CPU	LCD	VGA Chip
AS8943G-332G57Mn	WW	S2.PTL02.001	AS8943G_MADISON_PRO1GBTCFPss_3V3J	Ci3330M	NLED18.4 WUXGAGL	MADISON_PRO
AS8943G-332G57Mn	WW	S2.PTL02.001	AS8943G_MADISON_PRO1GBTCFPss_3V3J	Ci3330M	NLED18.4 WUXGAGL	MADISON_PRO
AS8943G-333G32Mn	Turkey	LX.PUJ02.058	AS8943G_MADISON_PRO1GBCFPss_3V3J	Ci3330M	NLED18.4 WUXGAGL	MADISON_PRO
AS8943G-334G50Mi	Russia	LX.PUJ02.006	AS8943G_MADISON_PRO1GBCFPss_3V3J	Ci3330M	NLED18.4 WUXGAGL	MADISON_PRO

Model	Country	Acer P/N	BOM Name	CPU	LCD	VGA Chip
AS8943G-334G50Mn	France	LX.PUJ02.004	AS8943G_MADISON_PRO1GBCFPss_3V3J	Ci3330M	NLED18.4 WUXGAGL	MADISON_PRO
AS8943G-334G64Mn	Belgium	LX.PU202.005	AS8943G_MADISON_PRO1GBCFPs_3V3J	Ci3330M	NLED18.4 WUXGAGL	MADISON_PRO
AS8943G-334G64Mn	Holland	LX.PU202.004	AS8943G_MADISON_PRO1GBCFPs_3V3J	Ci3330M	NLED18.4 WUXGAGL	MADISON_PRO
AS8943G-334G64Mn	Luxembourg	LX.PU202.003	AS8943G_MADISON_PRO1GBCFPs_3V3J	Ci3330M	NLED18.4 WUXGAGL	MADISON_PRO
AS8943G-354G50Mn	France	LX.PUJ02.059	AS8943G_MADISON_PRO1GBCFPss_3V3J	Ci3350M	NLED18.4 WUXGAGL	MADISON_PRO
AS8943G-432G82Mn	WW	S2.PTL02.003	AS8943G_MADISON_PRO1GBTCFPss_3V3J	Ci5430M	NLED18.4 WUXGAGL	MADISON_PRO
AS8943G-432G82Mn	WW	S2.PTL02.003	AS8943G_MADISON_PRO1GBTCFPss_3V3J	Ci5430M	NLED18.4 WUXGAGL	MADISON_PRO
AS8943G-434G1TBi	Russia	LX.PUJ02.051	AS8943G_MADISON_PRO1GBCFPss_3V3J	Ci5430M	NLED18.4 WUXGAGL	MADISON_PRO
AS8943G-434G1TBn	Algeria	LX.PUJ02.027	AS8943G_MADISON_PRO1GBCFPss_3V3J	Ci5430M	NLED18.4 WUXGAGL	MADISON_PRO
AS8943G-434G1TBn	Austria	LX.PUJ02.009	AS8943G_MADISON_PRO1GBCFPss_3V3J	Ci5430M	NLED18.4 WUXGAGL	MADISON_PRO
AS8943G-434G1TBn	Baltic	LX.PUJ02.047	AS8943G_MADISON_PRO1GBCFPss_3V3J	Ci5430M	NLED18.4 WUXGAGL	MADISON_PRO
AS8943G-434G1TBn	Baltic	LX.PUJ02.020	AS8943G_MADISON_PRO1GBCFPss_3V3J	Ci5430M	NLED18.4 WUXGAGL	MADISON_PRO
AS8943G-434G1TBn	Baltic	LX.PUJ02.017	AS8943G_MADISON_PRO1GBCFPss_3V3J	Ci5430M	NLED18.4 WUXGAGL	MADISON_PRO
AS8943G-434G1TBn	Belgium	LX.PUJ02.045	AS8943G_MADISON_PRO1GBCFPss_3V3J	Ci5430M	NLED18.4 WUXGAGL	MADISON_PRO
AS8943G-434G1TBn	Cyprus	LX.PUJ02.018	AS8943G_MADISON_PRO1GBCFPss_3V3J	Ci5430M	NLED18.4 WUXGAGL	MADISON_PRO
AS8943G-434G1TBn	Czech	LX.PUJ02.037	AS8943G_MADISON_PRO1GBCFPss_3V3J	Ci5430M	NLED18.4 WUXGAGL	MADISON_PRO
AS8943G-434G1TBn	Denmark	LX.PUJ02.013	AS8943G_MADISON_PRO1GBCFPss_3V3J	Ci5430M	NLED18.4 WUXGAGL	MADISON_PRO

Model	Country	Acer P/N	BOM Name	CPU	LCD	VGA Chip
AS8943G-434G1TBn	Eastern Europe	LX.PUJ02.039	AS8943G_MADISON_PRO1GBCFPss_3V3J	Ci5430M	NLED18.4 WUXGAGL	MADISON_PRO
AS8943G-434G1TBn	Eastern Europe	LX.PUJ02.038	AS8943G_MADISON_PRO1GBCFPss_3V3J	Ci5430M	NLED18.4 WUXGAGL	MADISON_PRO
AS8943G-434G1TBn	Eastern Europe	LX.PUJ02.012	AS8943G_MADISON_PRO1GBCFPss_3V3J	Ci5430M	NLED18.4 WUXGAGL	MADISON_PRO
AS8943G-434G1TBn	Eastern Europe	LX.PUJ02.011	AS8943G_MADISON_PRO1GBCFPss_3V3J	Ci5430M	NLED18.4 WUXGAGL	MADISON_PRO
AS8943G-434G1TBn	Eastern Europe	LX.PUJ02.007	AS8943G_MADISON_PRO1GBCFPss_3V3J	Ci5430M	NLED18.4 WUXGAGL	MADISON_PRO
AS8943G-434G1TBn	France	LX.PUJ02.008	AS8943G_MADISON_PRO1GBCFPss_3V3J	Ci5430M	NLED18.4 WUXGAGL	MADISON_PRO
AS8943G-434G1TBn	Germany	LX.PUJ02.049	AS8943G_MADISON_PRO1GBCFPss_3V3J	Ci5430M	NLED18.4 WUXGAGL	MADISON_PRO
AS8943G-434G1TBn	Greece	LX.PUJ02.010	AS8943G_MADISON_PRO1GBCFPss_3V3J	Ci5430M	NLED18.4 WUXGAGL	MADISON_PRO
AS8943G-434G1TBn	Holland	LX.PUJ02.046	AS8943G_MADISON_PRO1GBCFPss_3V3J	Ci5430M	NLED18.4 WUXGAGL	MADISON_PRO
AS8943G-434G1TBn	Hungary	LX.PUJ02.036	AS8943G_MADISON_PRO1GBCFPss_3V3J	Ci5430M	NLED18.4 WUXGAGL	MADISON_PRO
AS8943G-434G1TBn	Israel	LX.PUJ02.035	AS8943G_MADISON_PRO1GBCFPss_3V3J	Ci5430M	NLED18.4 WUXGAGL	MADISON_PRO
AS8943G-434G1TBn	Italy	LX.PUJ02.015	AS8943G_MADISON_PRO1GBCFPss_3V3J	Ci5430M	NLED18.4 WUXGAGL	MADISON_PRO
AS8943G-434G1TBn	Latvia	LX.PUJ02.042	AS8943G_MADISON_PRO1GBCFPss_3V3J	Ci5430M	NLED18.4 WUXGAGL	MADISON_PRO
AS8943G-434G1TBn	Latvia	LX.PUJ02.041	AS8943G_MADISON_PRO1GBCFPss_3V3J	Ci5430M	NLED18.4 WUXGAGL	MADISON_PRO
AS8943G-434G1TBn	Luxembourg	LX.PUJ02.043	AS8943G_MADISON_PRO1GBCFPss_3V3J	Ci5430M	NLED18.4 WUXGAGL	MADISON_PRO
AS8943G-434G1TBn	Middle East	LX.PUJ02.050	AS8943G_MADISON_PRO1GBCFPss_3V3J	Ci5430M	NLED18.4 WUXGAGL	MADISON_PRO
AS8943G-434G1TBn	Middle East	LX.PUJ02.034	AS8943G_MADISON_PRO1GBCFPss_3V3J	Ci5430M	NLED18.4 WUXGAGL	MADISON_PRO

Model	Country	Acer P/N	BOM Name	CPU	LCD	VGA Chip
AS8943G-434G1TBn	Middle East	LX.PUJ02.031	AS8943G_MADISON_PRO1GBCFPss_3V3J	Ci5430M	NLED18.4 WUXGAGL	MADISON_PRO
AS8943G-434G1TBn	Middle East	LX.PUJ02.030	AS8943G_MADISON_PRO1GBCFPss_3V3J	Ci5430M	NLED18.4 WUXGAGL	MADISON_PRO
AS8943G-434G1TBn	Middle East	LX.PUJ02.028	AS8943G_MADISON_PRO1GBCFPss_3V3J	Ci5430M	NLED18.4 WUXGAGL	MADISON_PRO
AS8943G-434G1TBn	Middle East	LX.PUJ02.025	AS8943G_MADISON_PRO1GBCFPss_3V3J	Ci5430M	NLED18.4 WUXGAGL	MADISON_PRO
AS8943G-434G1TBn	Middle East	LX.PUJ02.024	AS8943G_MADISON_PRO1GBCFPss_3V3J	Ci5430M	NLED18.4 WUXGAGL	MADISON_PRO
AS8943G-434G1TBn	Middle East	LX.PUJ02.023	AS8943G_MADISON_PRO1GBCFPss_3V3J	Ci5430M	NLED18.4 WUXGAGL	MADISON_PRO
AS8943G-434G1TBn	Middle East	LX.PUJ02.022	AS8943G_MADISON_PRO1GBCFPss_3V3J	Ci5430M	NLED18.4 WUXGAGL	MADISON_PRO
AS8943G-434G1TBn	Poland	LX.PUJ02.048	AS8943G_MADISON_PRO1GBCFPss_3V3J	Ci5430M	NLED18.4 WUXGAGL	MADISON_PRO
AS8943G-434G1TBn	Portugal	LX.PUJ02.019	AS8943G_MADISON_PRO1GBCFPss_3V3J	Ci5430M	NLED18.4 WUXGAGL	MADISON_PRO
AS8943G-434G1TBn	Serbia/Macedonia	LX.PUJ02.016	AS8943G_MADISON_PRO1GBCFPss_3V3J	Ci5430M	NLED18.4 WUXGAGL	MADISON_PRO
AS8943G-434G1TBn	South Africa	LX.PUJ02.033	AS8943G_MADISON_PRO1GBCFPss_3V3J	Ci5430M	NLED18.4 WUXGAGL	MADISON_PRO
AS8943G-434G1TBn	South Africa	LX.PUJ02.029	AS8943G_MADISON_PRO1GBCFPss_3V3J	Ci5430M	NLED18.4 WUXGAGL	MADISON_PRO
AS8943G-434G1TBn	South Africa	LX.PUJ02.026	AS8943G_MADISON_PRO1GBCFPss_3V3J	Ci5430M	NLED18.4 WUXGAGL	MADISON_PRO
AS8943G-434G1TBn	South Africa	LX.PUJ02.021	AS8943G_MADISON_PRO1GBCFPss_3V3J	Ci5430M	NLED18.4 WUXGAGL	MADISON_PRO
AS8943G-434G1TBn	Spain	LX.PUJ02.014	AS8943G_MADISON_PRO1GBCFPss_3V3J	Ci5430M	NLED18.4 WUXGAGL	MADISON_PRO
AS8943G-434G1TBn	Switzerland	LX.PUJ02.044	AS8943G_MADISON_PRO1GBCFPss_3V3J	Ci5430M	NLED18.4 WUXGAGL	MADISON_PRO
AS8943G-434G1TBn	Turkey	LX.PUJ02.032	AS8943G_MADISON_PRO1GBCFPss_3V3J	Ci5430M	NLED18.4 WUXGAGL	MADISON_PRO

Model	Country	Acer P/N	BOM Name	CPU	LCD	VGA Chip
AS8943G-434G1TBn	UK	LX.PUJ02.040	AS8943G_MADISON_PRO1GBCFPss_3V3J	Ci5430M	NLED18.4 WUXGAGL	MADISON_PRO
AS8943G-434G1TBn	Ukraine	LX.PUJ02.052	AS8943G_MADISON_PRO1GBCFPss_3V3J	Ci5430M	NLED18.4 WUXGAGL	MADISON_PRO
AS8943G-434G1TMn	Belgium	LX.PUJ02.055	AS8943G_MADISON_PRO1GBCFPss_3V3J	Ci5430M	NLED18.4 WUXGAGL	MADISON_PRO
AS8943G-434G1TMn	France	LX.PUJ02.003	AS8943G_MADISON_PRO1GBCFPss_3V3J	Ci5430M	NLED18.4 WUXGAGL	MADISON_PRO
AS8943G-434G1TMn	Holland	LX.PUJ02.054	AS8943G_MADISON_PRO1GBCFPss_3V3J	Ci5430M	NLED18.4 WUXGAGL	MADISON_PRO
AS8943G-434G1TMn	Luxembourg	LX.PUJ02.053	AS8943G_MADISON_PRO1GBCFPss_3V3J	Ci5430M	NLED18.4 WUXGAGL	MADISON_PRO
AS8943G-434G32Mn	Austria	LX.PU202.006	AS8943G_MADISON_PRO1GBCFPs_s_3V3J	Ci5430M	NLED18.4 WUXGAGL	MADISON_PRO
AS8943G-434G32Mn	Germany	LX.PU202.002	AS8943G_MADISON_PRO1GBCFPs_s_3V3J	Ci5430M	NLED18.4 WUXGAGL	MADISON_PRO
AS8943G-434G50Bn	UK	LX.PU202.007	AS8943G_MADISON_PRO1GBCFPs_s_3V3J	Ci5430M	NLED18.4 WUXGAGL	MADISON_PRO
AS8943G-434G50Mn	Denmark	LX.PU102.092	AS8943G_BROADWAY_PRO1GBCFPss_3V3J	Ci5430M	NLED18.4 WUXGAGL	BROADWAY_PRO
AS8943G-434G50Mn	Spain	LX.PUJ02.001	AS8943G_MADISON_PRO1GBCFPss_3V3J	Ci5430M	NLED18.4 WUXGAGL	MADISON_PRO
AS8943G-434G50Mn	Turkey	LX.PUJ02.056	AS8943G_MADISON_PRO1GBCFPss_3V3J	Ci5430M	NLED18.4 WUXGAGL	MADISON_PRO
AS8943G-434G64Bi	Russia	LX.PU102.099	AS8943G_BROADWAY_PRO1GBCFPss_3V3J	Ci5430M	NLED18.4 WUXGAGL	BROADWAY_PRO
AS8943G-434G64Bn	Czech	LX.PU102.103	AS8943G_BROADWAY_PRO1GBCFPss_3V3J	Ci5430M	NLED18.4 WUXGAGL	BROADWAY_PRO
AS8943G-434G64Mi	Russia	LX.PUJ02.060	AS8943G_MADISON_PRO1GBCFPss_3V3J	Ci5430M	NLED18.4 WUXGAGL	MADISON_PRO
AS8943G-434G64Mi	Russia	LX.PU102.044	AS8943G_BROADWAY_PRO1GBCFPss_3V3J	Ci5430M	NLED18.4 WUXGAGL	BROADWAY_PRO
AS8943G-434G64Mn	Algeria	LX.PU102.036	AS8943G_BROADWAY_PRO1GBCFPss_3V3J	Ci5430M	NLED18.4 WUXGAGL	BROADWAY_PRO

Model	Country	Acer P/N	BOM Name	CPU	LCD	VGA Chip
AS8943G-434G64Mn	Austria	LX.PU102.003	AS8943G_BROADWAY_PRO1GBCFPss_3V3J	Ci5430M	NLED18.4WUXGAGL	BROADWAY_PRO
AS8943G-434G64Mn	Baltic	LX.PU102.022	AS8943G_BROADWAY_PRO1GBCFPss_3V3J	Ci5430M	NLED18.4WUXGAGL	BROADWAY_PRO
AS8943G-434G64Mn	Baltic	LX.PU102.014	AS8943G_BROADWAY_PRO1GBCFPss_3V3J	Ci5430M	NLED18.4WUXGAGL	BROADWAY_PRO
AS8943G-434G64Mn	Baltic	LX.PU102.011	AS8943G_BROADWAY_PRO1GBCFPss_3V3J	Ci5430M	NLED18.4WUXGAGL	BROADWAY_PRO
AS8943G-434G64Mn	Belgium	LX.PU102.033	AS8943G_BROADWAY_PRO1GBCFPss_3V3J	Ci5430M	NLED18.4WUXGAGL	BROADWAY_PRO
AS8943G-434G64Mn	Cyprus	LX.PU102.013	AS8943G_BROADWAY_PRO1GBCFPss_3V3J	Ci5430M	NLED18.4WUXGAGL	BROADWAY_PRO
AS8943G-434G64Mn	Czech	LX.PU102.017	AS8943G_BROADWAY_PRO1GBCFPss_3V3J	Ci5430M	NLED18.4WUXGAGL	BROADWAY_PRO
AS8943G-434G64Mn	Denmark	LX.PU102.009	AS8943G_BROADWAY_PRO1GBCFPss_3V3J	Ci5430M	NLED18.4WUXGAGL	BROADWAY_PRO
AS8943G-434G64Mn	Eastern Europe	LX.PU102.020	AS8943G_BROADWAY_PRO1GBCFPss_3V3J	Ci5430M	NLED18.4WUXGAGL	BROADWAY_PRO
AS8943G-434G64Mn	Eastern Europe	LX.PU102.019	AS8943G_BROADWAY_PRO1GBCFPss_3V3J	Ci5430M	NLED18.4WUXGAGL	BROADWAY_PRO
AS8943G-434G64Mn	Eastern Europe	LX.PU102.008	AS8943G_BROADWAY_PRO1GBCFPss_3V3J	Ci5430M	NLED18.4WUXGAGL	BROADWAY_PRO
AS8943G-434G64Mn	Eastern Europe	LX.PU102.007	AS8943G_BROADWAY_PRO1GBCFPss_3V3J	Ci5430M	NLED18.4WUXGAGL	BROADWAY_PRO
AS8943G-434G64Mn	Eastern Europe	LX.PU102.002	AS8943G_BROADWAY_PRO1GBCFPss_3V3J	Ci5430M	NLED18.4WUXGAGL	BROADWAY_PRO
AS8943G-434G64Mn	France	LX.PU102.001	AS8943G_BROADWAY_PRO1GBCFPss_3V3J	Ci5430M	NLED18.4WUXGAGL	BROADWAY_PRO
AS8943G-434G64Mn	Germany	LX.PU102.023	AS8943G_BROADWAY_PRO1GBCFPss_3V3J	Ci5430M	NLED18.4WUXGAGL	BROADWAY_PRO
AS8943G-434G64Mn	Greece	LX.PU102.004	AS8943G_BROADWAY_PRO1GBCFPss_3V3J	Ci5430M	NLED18.4WUXGAGL	BROADWAY_PRO
AS8943G-434G64Mn	Holland	LX.PU102.034	AS8943G_BROADWAY_PRO1GBCFPss_3V3J	Ci5430M	NLED18.4WUXGAGL	BROADWAY_PRO

Model	Country	Acer P/N	BOM Name	CPU	LCD	VGA Chip
AS8943G-434G64Mn	Hungary	LX.PU102.016	AS8943G_BROADWAY_PRO1GBCFPss_3V3J	Ci5430M	NLED18.4 WUXGAGL	BROADWAY_PRO
AS8943G-434G64Mn	Israel	LX.PU102.015	AS8943G_BROADWAY_PRO1GBCFPss_3V3J	Ci5430M	NLED18.4 WUXGAGL	BROADWAY_PRO
AS8943G-434G64Mn	Italy	LX.PU102.006	AS8943G_BROADWAY_PRO1GBCFPss_3V3J	Ci5430M	NLED18.4 WUXGAGL	BROADWAY_PRO
AS8943G-434G64Mn	Latvia	LX.PU102.031	AS8943G_BROADWAY_PRO1GBCFPss_3V3J	Ci5430M	NLED18.4 WUXGAGL	BROADWAY_PRO
AS8943G-434G64Mn	Latvia	LX.PU102.021	AS8943G_BROADWAY_PRO1GBCFPss_3V3J	Ci5430M	NLED18.4 WUXGAGL	BROADWAY_PRO
AS8943G-434G64Mn	Luxembourg	LX.PU102.035	AS8943G_BROADWAY_PRO1GBCFPss_3V3J	Ci5430M	NLED18.4 WUXGAGL	BROADWAY_PRO
AS8943G-434G64Mn	Middle East	LX.PU102.043	AS8943G_BROADWAY_PRO1GBCFPss_3V3J	Ci5430M	NLED18.4 WUXGAGL	BROADWAY_PRO
AS8943G-434G64Mn	Middle East	LX.PU102.042	AS8943G_BROADWAY_PRO1GBCFPss_3V3J	Ci5430M	NLED18.4 WUXGAGL	BROADWAY_PRO
AS8943G-434G64Mn	Middle East	LX.PU102.039	AS8943G_BROADWAY_PRO1GBCFPss_3V3J	Ci5430M	NLED18.4 WUXGAGL	BROADWAY_PRO
AS8943G-434G64Mn	Middle East	LX.PU102.038	AS8943G_BROADWAY_PRO1GBCFPss_3V3J	Ci5430M	NLED18.4 WUXGAGL	BROADWAY_PRO
AS8943G-434G64Mn	Middle East	LX.PU102.037	AS8943G_BROADWAY_PRO1GBCFPss_3V3J	Ci5430M	NLED18.4 WUXGAGL	BROADWAY_PRO
AS8943G-434G64Mn	Middle East	LX.PU102.029	AS8943G_BROADWAY_PRO1GBCFPss_3V3J	Ci5430M	NLED18.4 WUXGAGL	BROADWAY_PRO
AS8943G-434G64Mn	Middle East	LX.PU102.028	AS8943G_BROADWAY_PRO1GBCFPss_3V3J	Ci5430M	NLED18.4 WUXGAGL	BROADWAY_PRO
AS8943G-434G64Mn	Middle East	LX.PU102.027	AS8943G_BROADWAY_PRO1GBCFPss_3V3J	Ci5430M	NLED18.4 WUXGAGL	BROADWAY_PRO
AS8943G-434G64Mn	Middle East	LX.PU102.026	AS8943G_BROADWAY_PRO1GBCFPss_3V3J	Ci5430M	NLED18.4 WUXGAGL	BROADWAY_PRO
AS8943G-434G64Mn	Poland	LX.PU102.024	AS8943G_BROADWAY_PRO1GBCFPss_3V3J	Ci5430M	NLED18.4 WUXGAGL	BROADWAY_PRO
AS8943G-434G64Mn	Portugal	LX.PU102.012	AS8943G_BROADWAY_PRO1GBCFPss_3V3J	Ci5430M	NLED18.4 WUXGAGL	BROADWAY_PRO

Model	Country	Acer P/N	BOM Name	CPU	LCD	VGA Chip
AS8943G-434G64Mn	Serbia/Macedonia	LX.PU102.010	AS8943G_BROADWAY_PRO1GBCFPss_3V3J	Ci5430M	NLED18.4 WUXGAGL	BROADWAY_PRO
AS8943G-434G64Mn	South Africa	LX.PU102.041	AS8943G_BROADWAY_PRO1GBCFPss_3V3J	Ci5430M	NLED18.4 WUXGAGL	BROADWAY_PRO
AS8943G-434G64Mn	South Africa	LX.PU102.030	AS8943G_BROADWAY_PRO1GBCFPss_3V3J	Ci5430M	NLED18.4 WUXGAGL	BROADWAY_PRO
AS8943G-434G64Mn	South Africa	LX.PU102.025	AS8943G_BROADWAY_PRO1GBCFPss_3V3J	Ci5430M	NLED18.4 WUXGAGL	BROADWAY_PRO
AS8943G-434G64Mn	Spain	LX.PUJ02.002	AS8943G_MADISON_PRO1GBCFPss_3V3J	Ci5430M	NLED18.4 WUXGAGL	MADISON_PRO
AS8943G-434G64Mn	Spain	LX.PU102.005	AS8943G_BROADWAY_PRO1GBCFPss_3V3J	Ci5430M	NLED18.4 WUXGAGL	BROADWAY_PRO
AS8943G-434G64Mn	Switzerland	LX.PU102.032	AS8943G_BROADWAY_PRO1GBCFPss_3V3J	Ci5430M	NLED18.4 WUXGAGL	BROADWAY_PRO
AS8943G-434G64Mn	Turkey	LX.PU102.097	AS8943G_BROADWAY_PRO1GBCFPss_3V3J	Ci5430M	NLED18.4 WUXGAGL	BROADWAY_PRO
AS8943G-434G64Mn	Turkey	LX.PU102.040	AS8943G_BROADWAY_PRO1GBCFPss_3V3J	Ci5430M	NLED18.4 WUXGAGL	BROADWAY_PRO
AS8943G-434G64Mn	UK	LX.PU102.018	AS8943G_BROADWAY_PRO1GBCFPss_3V3J	Ci5430M	NLED18.4 WUXGAGL	BROADWAY_PRO
AS8943G-434G64Mn	Ukraine	LX.PU102.045	AS8943G_BROADWAY_PRO1GBCFPss_3V3J	Ci5430M	NLED18.4 WUXGAGL	BROADWAY_PRO
AS8943G-436G1TBi	Russia	LX.PU102.089	AS8943G_BROADWAY_PRO1GBCFPss_3V3J	Ci5430M	NLED18.4 WUXGAGL	BROADWAY_PRO
AS8943G-436G1TBn	Algeria	LX.PU102.081	AS8943G_BROADWAY_PRO1GBCFPss_3V3J	Ci5430M	NLED18.4 WUXGAGL	BROADWAY_PRO
AS8943G-436G1TBn	Austria	LX.PU102.048	AS8943G_BROADWAY_PRO1GBCFPss_3V3J	Ci5430M	NLED18.4 WUXGAGL	BROADWAY_PRO
AS8943G-436G1TBn	Baltic	LX.PU102.072	AS8943G_BROADWAY_PRO1GBCFPss_3V3J	Ci5430M	NLED18.4 WUXGAGL	BROADWAY_PRO
AS8943G-436G1TBn	Baltic	LX.PU102.059	AS8943G_BROADWAY_PRO1GBCFPss_3V3J	Ci5430M	NLED18.4 WUXGAGL	BROADWAY_PRO
AS8943G-436G1TBn	Baltic	LX.PU102.056	AS8943G_BROADWAY_PRO1GBCFPss_3V3J	Ci5430M	NLED18.4 WUXGAGL	BROADWAY_PRO

Model	Country	Acer P/N	BOM Name	CPU	LCD	VGA Chip
AS8943G-436G1TBn	Belgium	LX.PU102.069	AS8943G_BROADWAY_PRO1GBCFPss_3V3J	Ci5430M	NLED18.4 WUXGAGL	BROADWAY_PRO
AS8943G-436G1TBn	Cyprus	LX.PU102.058	AS8943G_BROADWAY_PRO1GBCFPss_3V3J	Ci5430M	NLED18.4 WUXGAGL	BROADWAY_PRO
AS8943G-436G1TBn	Czech	LX.PU102.062	AS8943G_BROADWAY_PRO1GBCFPss_3V3J	Ci5430M	NLED18.4 WUXGAGL	BROADWAY_PRO
AS8943G-436G1TBn	Denmark	LX.PU102.054	AS8943G_BROADWAY_PRO1GBCFPss_3V3J	Ci5430M	NLED18.4 WUXGAGL	BROADWAY_PRO
AS8943G-436G1TBn	Eastern Europe	LX.PU102.065	AS8943G_BROADWAY_PRO1GBCFPss_3V3J	Ci5430M	NLED18.4 WUXGAGL	BROADWAY_PRO
AS8943G-436G1TBn	Eastern Europe	LX.PU102.064	AS8943G_BROADWAY_PRO1GBCFPss_3V3J	Ci5430M	NLED18.4 WUXGAGL	BROADWAY_PRO
AS8943G-436G1TBn	Eastern Europe	LX.PU102.053	AS8943G_BROADWAY_PRO1GBCFPss_3V3J	Ci5430M	NLED18.4 WUXGAGL	BROADWAY_PRO
AS8943G-436G1TBn	Eastern Europe	LX.PU102.052	AS8943G_BROADWAY_PRO1GBCFPss_3V3J	Ci5430M	NLED18.4 WUXGAGL	BROADWAY_PRO
AS8943G-436G1TBn	Eastern Europe	LX.PU102.047	AS8943G_BROADWAY_PRO1GBCFPss_3V3J	Ci5430M	NLED18.4 WUXGAGL	BROADWAY_PRO
AS8943G-436G1TBn	France	LX.PU102.046	AS8943G_BROADWAY_PRO1GBCFPss_3V3J	Ci5430M	NLED18.4 WUXGAGL	BROADWAY_PRO
AS8943G-436G1TBn	Germany	LX.PU102.073	AS8943G_BROADWAY_PRO1GBCFPss_3V3J	Ci5430M	NLED18.4 WUXGAGL	BROADWAY_PRO
AS8943G-436G1TBn	Greece	LX.PU102.049	AS8943G_BROADWAY_PRO1GBCFPss_3V3J	Ci5430M	NLED18.4 WUXGAGL	BROADWAY_PRO
AS8943G-436G1TBn	Holland	LX.PU102.070	AS8943G_BROADWAY_PRO1GBCFPss_3V3J	Ci5430M	NLED18.4 WUXGAGL	BROADWAY_PRO
AS8943G-436G1TBn	Hungary	LX.PU102.061	AS8943G_BROADWAY_PRO1GBCFPss_3V3J	Ci5430M	NLED18.4 WUXGAGL	BROADWAY_PRO
AS8943G-436G1TBn	Israel	LX.PU102.060	AS8943G_BROADWAY_PRO1GBCFPss_3V3J	Ci5430M	NLED18.4 WUXGAGL	BROADWAY_PRO
AS8943G-436G1TBn	Italy	LX.PU102.051	AS8943G_BROADWAY_PRO1GBCFPss_3V3J	Ci5430M	NLED18.4 WUXGAGL	BROADWAY_PRO
AS8943G-436G1TBn	Latvia	LX.PU102.067	AS8943G_BROADWAY_PRO1GBCFPss_3V3J	Ci5430M	NLED18.4 WUXGAGL	BROADWAY_PRO

Model	Country	Acer P/N	BOM Name	CPU	LCD	VGA Chip
AS8943G-436G1TBn	Latvia	LX.PU102.066	AS8943G_BROADWAY_PRO1GBCFPss_3V3J	Ci5430M	NLED18.4 WUXGAGL	BROADWAY_PRO
AS8943G-436G1TBn	Luxembourg	LX.PU102.071	AS8943G_BROADWAY_PRO1GBCFPss_3V3J	Ci5430M	NLED18.4 WUXGAGL	BROADWAY_PRO
AS8943G-436G1TBn	Middle East	LX.PU102.088	AS8943G_BROADWAY_PRO1GBCFPss_3V3J	Ci5430M	NLED18.4 WUXGAGL	BROADWAY_PRO
AS8943G-436G1TBn	Middle East	LX.PU102.087	AS8943G_BROADWAY_PRO1GBCFPss_3V3J	Ci5430M	NLED18.4 WUXGAGL	BROADWAY_PRO
AS8943G-436G1TBn	Middle East	LX.PU102.084	AS8943G_BROADWAY_PRO1GBCFPss_3V3J	Ci5430M	NLED18.4 WUXGAGL	BROADWAY_PRO
AS8943G-436G1TBn	Middle East	LX.PU102.083	AS8943G_BROADWAY_PRO1GBCFPss_3V3J	Ci5430M	NLED18.4 WUXGAGL	BROADWAY_PRO
AS8943G-436G1TBn	Middle East	LX.PU102.082	AS8943G_BROADWAY_PRO1GBCFPss_3V3J	Ci5430M	NLED18.4 WUXGAGL	BROADWAY_PRO
AS8943G-436G1TBn	Middle East	LX.PU102.079	AS8943G_BROADWAY_PRO1GBCFPss_3V3J	Ci5430M	NLED18.4 WUXGAGL	BROADWAY_PRO
AS8943G-436G1TBn	Middle East	LX.PU102.078	AS8943G_BROADWAY_PRO1GBCFPss_3V3J	Ci5430M	NLED18.4 WUXGAGL	BROADWAY_PRO
AS8943G-436G1TBn	Middle East	LX.PU102.077	AS8943G_BROADWAY_PRO1GBCFPss_3V3J	Ci5430M	NLED18.4 WUXGAGL	BROADWAY_PRO
AS8943G-436G1TBn	Middle East	LX.PU102.076	AS8943G_BROADWAY_PRO1GBCFPss_3V3J	Ci5430M	NLED18.4 WUXGAGL	BROADWAY_PRO
AS8943G-436G1TBn	Poland	LX.PU102.074	AS8943G_BROADWAY_PRO1GBCFPss_3V3J	Ci5430M	NLED18.4 WUXGAGL	BROADWAY_PRO
AS8943G-436G1TBn	Portugal	LX.PU102.057	AS8943G_BROADWAY_PRO1GBCFPss_3V3J	Ci5430M	NLED18.4 WUXGAGL	BROADWAY_PRO
AS8943G-436G1TBn	Serbia/Macedonia	LX.PU102.055	AS8943G_BROADWAY_PRO1GBCFPss_3V3J	Ci5430M	NLED18.4 WUXGAGL	BROADWAY_PRO
AS8943G-436G1TBn	South Africa	LX.PU102.086	AS8943G_BROADWAY_PRO1GBCFPss_3V3J	Ci5430M	NLED18.4 WUXGAGL	BROADWAY_PRO
AS8943G-436G1TBn	South Africa	LX.PU102.080	AS8943G_BROADWAY_PRO1GBCFPss_3V3J	Ci5430M	NLED18.4 WUXGAGL	BROADWAY_PRO
AS8943G-436G1TBn	South Africa	LX.PU102.075	AS8943G_BROADWAY_PRO1GBCFPss_3V3J	Ci5430M	NLED18.4 WUXGAGL	BROADWAY_PRO

Model	Country	Acer P/N	BOM Name	CPU	LCD	VGA Chip
AS8943G-436G1TBn	Spain	LX.PU102.050	AS8943G_BROADWAY_PRO1GBCFPss_3V3J	Ci5430M	NLED18.4 WUXGAGL	BROADWAY_PRO
AS8943G-436G1TBn	Switzerland	LX.PU102.068	AS8943G_BROADWAY_PRO1GBCFPss_3V3J	Ci5430M	NLED18.4 WUXGAGL	BROADWAY_PRO
AS8943G-436G1TBn	Turkey	LX.PU102.085	AS8943G_BROADWAY_PRO1GBCFPss_3V3J	Ci5430M	NLED18.4 WUXGAGL	BROADWAY_PRO
AS8943G-436G1TBn	UK	LX.PU102.063	AS8943G_BROADWAY_PRO1GBCFPss_3V3J	Ci5430M	NLED18.4 WUXGAGL	BROADWAY_PRO
AS8943G-436G1TBn	Ukraine	LX.PU102.090	AS8943G_BROADWAY_PRO1GBCFPss_3V3J	Ci5430M	NLED18.4 WUXGAGL	BROADWAY_PRO
AS8943G-436G1TWN	Turkey	LX.PU102.098	AS8943G_BROADWAY_PRO1GBCFPss_3V3J	Ci5430M	NLED18.4 WUXGAGL	BROADWAY_PRO
AS8943G-438G1TBn	Switzerland	LX.PU102.096	AS8943G_BROADWAY_PRO1GBCFPss_3V3J	Ci5430M	NLED18.4 WUXGAGL	BROADWAY_PRO
AS8943G-438G64Bn	Switzerland	LX.PU102.095	AS8943G_BROADWAY_PRO1GBCFPss_3V3J	Ci5430M	NLED18.4 WUXGAGL	BROADWAY_PRO
AS8943G-524G64Mn	WW	S2.PTL02.002	AS8943G_MADISON_PRO1GBTCFPss_3V3J	Ci5520M	NLED18.4 WUXGAGL	MADISON_PRO
AS8943G-524G64Mn	WW	S2.PTL02.002	AS8943G_MADISON_PRO1GBTCFPss_3V3J	Ci5520M	NLED18.4 WUXGAGL	MADISON_PRO
AS8943G-524G64Mn	WW	S2.PTJ02.002	AS8943G_BROADWAY_PRO1GBTCFss_3V3J	Ci5520M	NLED18.4 WUXGAGL	BROADWAY_PRO
AS8943G-524G64Mn	WW	S2.PTJ02.002	AS8943G_BROADWAY_PRO1GBTCFss_3V3J	Ci5520M	NLED18.4 WUXGAGL	BROADWAY_PRO
AS8943G-526G1TWN	Turkey	LX.PU102.102	AS8943G_BROADWAY_PRO1GBCFPss_3V3J	Ci5520M	NLED18.4 WUXGAGL	BROADWAY_PRO
AS8943G-526G64Mn	Turkey	LX.PUJ02.057	AS8943G_MADISON_PRO1GBCFPss_3V3J	Ci5520M	NLED18.4 WUXGAGL	MADISON_PRO
AS8943G-544G1TMn	WW	S2.PUJ02.001	AS8943G_MADISON_PRO1GBCFPss_3V3J	Ci5540M	NLED18.4 WUXGAGL	MADISON_PRO
AS8943G-544G1TMn	WW	S2.PUJ02.001	AS8943G_MADISON_PRO1GBCFPss_3V3J	Ci5540M	NLED18.4 WUXGAGL	MADISON_PRO
AS8943G-544G64Bn	WW	S2.PTJ02.001	AS8943G_BROADWAY_PRO1GBTCFss_3V3J	Ci5540M	NLED18.4 WUXGAGL	BROADWAY_PRO

Model	Country	Acer P/N	BOM Name	CPU	LCD	VGA Chip
AS8943G-544G64Bn	WW	S2.PTJ02.001	AS8943G_BROADWAY_PRO1GBTCFss_3V3J	Ci5540M	NLED18.4 WUXGAGL	BROADWAY_PRO
AS8943G-624G1.28TBn	France	LX.PU102.093	AS8943G_BROADWAY_PRO1GBCFPss_3V3J	Ci7620M	NLED18.4 WUXGAGL	BROADWAY_PRO
AS8943G-624G1TMn	France	LX.PU102.094	AS8943G_BROADWAY_PRO1GBCFPss_3V3J	Ci7620M	NLED18.4 WUXGAGL	BROADWAY_PRO
AS8943G-624G64Mn	China	LX.PU202.001	AS8943G_MADISON_PRO1GBCFss_3V3J	Ci7620M	NLED18.4 WUXGAGL	MADISON_PRO
AS8943G-624G64Mn	Hong Kong	LX.PU102.091	AS8943G_BROADWAY_PRO1GBCFPss_3V3J	Ci7620M	NLED18.4 WUXGAGL	BROADWAY_PRO
AS8943G-626G1TWn	Turkey	LX.PUJ02.005	AS8943G_MADISON_PRO1GBCFPss_3V3J	Ci7620M	NLED18.4 WUXGAGL	MADISON_PRO
AS8943G-626G1TWn	Turkey	LX.PU102.101	AS8943G_BROADWAY_PRO1GBCFPss_3V3J	Ci7620M	NLED18.4 WUXGAGL	BROADWAY_PRO
AS8943G-628G1TMn	WW	S2.PU202.001	AS8943G_MADISON_PRO1GBCFss_3V3J	Ci7620M	NLED18.4 WUXGAGL	MADISON_PRO
AS8943G-628G1TMn	WW	S2.PU202.001	AS8943G_MADISON_PRO1GBCFss_3V3J	Ci7620M	NLED18.4 WUXGAGL	MADISON_PRO
AS8943G-72101.28TWn	Singapore	LX.PUH02.236	AS8943G_BROADWAY_PRO1GBCFPssQ_3D4V3J	Ci7720QM	NLED18.4 WUXGAGL	BROADWAY_PRO
AS8943G-72101.28TWn	Singapore	LX.PUG02.010	AS8943G_BROADWAY_PRO1GBCFPssQ_3D4V3J	Ci7720QM	NLED18.4 WUXGAGL	BROADWAY_PRO
AS8943G-72161.28TWn	Belgium	LX.PUH02.246	AS8943G_BROADWAY_PRO1GBCFPssQ_3D4V3J	Ci7720QM	NLED18.4 WUXGAGL	BROADWAY_PRO
AS8943G-72161.28TWn	Germany	LX.PUH02.188	AS8943G_BROADWAY_PRO1GBCFPssQ_3D4V3J	Ci7720QM	NLED18.4 WUXGAGL	BROADWAY_PRO
AS8943G-72161.28TWn	Holland	LX.PUH02.245	AS8943G_BROADWAY_PRO1GBCFPssQ_3D4V3J	Ci7720QM	NLED18.4 WUXGAGL	BROADWAY_PRO
AS8943G-72161.28TWn	Luxembourg	LX.PUH02.244	AS8943G_BROADWAY_PRO1GBCFPssQ_3D4V3J	Ci7720QM	NLED18.4 WUXGAGL	BROADWAY_PRO
AS8943G-72161.28TWn	Singapore	LX.PUH02.190	AS8943G_BROADWAY_PRO1GBCFPssQ_3D4V3J	Ci7720QM	NLED18.4 WUXGAGL	BROADWAY_PRO
AS8943G-72161.28TWn	Singapore	LX.PUG02.009	AS8943G_BROADWAY_PRO1GBCFPssQ_3D4V3J	Ci7720QM	NLED18.4 WUXGAGL	BROADWAY_PRO

Model	Country	Acer P/N	BOM Name	CPU	LCD	VGA Chip
AS8943G-72161.28T Wn	Spain	LX.PUG02 .003	AS8943G_BROADWAY_PRO1GBTCFPssQ_3D4V3J	Ci7720QM	NLED18.4 WUXGAGL	BROADWAY_PRO
AS8943G-72161.28T Wn	UK	LX.PUG02 .014	AS8943G_BROADWAY_PRO1GBTCFPssQ_3D4V3J	Ci7720QM	NLED18.4 WUXGAGL	BROADWAY_PRO
AS8943G-721632Wn	Poland	LX.PUH02 .255	AS8943G_BROADWAY_PRO1GBCFPssQ_3D4V3J	Ci7720QM	NLED18.4 WUXGAGL	BROADWAY_PRO
AS8943G-721682Bn	WW	S2.PUG02 .002	AS8943G_BROADWAY_PRO1GBTCFPssQ_3D4V3J	Ci7720QM	NLED18.4 WUXGAGL	BROADWAY_PRO
AS8943G-721682Bn	WW	S2.PUG02 .002	AS8943G_BROADWAY_PRO1GBTCFPssQ_3D4V3J	Ci7720QM	NLED18.4 WUXGAGL	BROADWAY_PRO
AS8943G-724G1TBn	Belgium	LX.PUH02 .249	AS8943G_BROADWAY_PRO1GBCFPssQ_3D4V3J	Ci7720QM	NLED18.4 WUXGAGL	BROADWAY_PRO
AS8943G-724G1TBn	GCTWN	LX.PUH02 .183	AS8943G_BROADWAY_PRO1GBCFPssQ_3D4V3J	Ci7720QM	NLED18.4 WUXGAGL	BROADWAY_PRO
AS8943G-724G1TBn	GCTWN	LX.PUH02 .182	AS8943G_BROADWAY_PRO1GBCFPssQ_3D4V3J	Ci7720QM	NLED18.4 WUXGAGL	BROADWAY_PRO
AS8943G-724G1TBn	Germany	LX.PUH02 .239	AS8943G_BROADWAY_PRO1GBCFPssQ_3D4V3J	Ci7720QM	NLED18.4 WUXGAGL	BROADWAY_PRO
AS8943G-724G1TBn	Holland	LX.PUH02 .248	AS8943G_BROADWAY_PRO1GBCFPssQ_3D4V3J	Ci7720QM	NLED18.4 WUXGAGL	BROADWAY_PRO
AS8943G-724G1TBn	Hong Kong	LX.PUH02 .181	AS8943G_BROADWAY_PRO1GBCFPssQ_3D4V3J	Ci7720QM	NLED18.4 WUXGAGL	BROADWAY_PRO
AS8943G-724G1TBn	Luxembourg	LX.PUH02 .247	AS8943G_BROADWAY_PRO1GBCFPssQ_3D4V3J	Ci7720QM	NLED18.4 WUXGAGL	BROADWAY_PRO
AS8943G-724G1TMn	Algeria	LX.PUH02 .226	AS8943G_BROADWAY_PRO1GBCFPssQ_3D4V3J	Ci7720QM	NLED18.4 WUXGAGL	BROADWAY_PRO
AS8943G-724G1TMn	Austria	LX.PUH02 .193	AS8943G_BROADWAY_PRO1GBCFPssQ_3D4V3J	Ci7720QM	NLED18.4 WUXGAGL	BROADWAY_PRO
AS8943G-724G1TMn	Baltic	LX.PUH02 .218	AS8943G_BROADWAY_PRO1GBCFPssQ_3D4V3J	Ci7720QM	NLED18.4 WUXGAGL	BROADWAY_PRO
AS8943G-724G1TMn	Baltic	LX.PUH02 .205	AS8943G_BROADWAY_PRO1GBCFPssQ_3D4V3J	Ci7720QM	NLED18.4 WUXGAGL	BROADWAY_PRO
AS8943G-724G1TMn	Baltic	LX.PUH02 .202	AS8943G_BROADWAY_PRO1GBCFPssQ_3D4V3J	Ci7720QM	NLED18.4 WUXGAGL	BROADWAY_PRO

Model	Country	Acer P/N	BOM Name	CPU	LCD	VGA Chip
AS8943G-724G1TMn	Belgium	LX.PUH02.216	AS8943G_BROADWAY_PRO1GBCFPssQ_3D4V3J	Ci7720QM	NLED18.4WUXGAGL	BROADWAY_PRO
AS8943G-724G1TMn	Cyprus	LX.PUH02.203	AS8943G_BROADWAY_PRO1GBCFPssQ_3D4V3J	Ci7720QM	NLED18.4WUXGAGL	BROADWAY_PRO
AS8943G-724G1TMn	Czech	LX.PUH02.208	AS8943G_BROADWAY_PRO1GBCFPssQ_3D4V3J	Ci7720QM	NLED18.4WUXGAGL	BROADWAY_PRO
AS8943G-724G1TMn	Denmark	LX.PUH02.197	AS8943G_BROADWAY_PRO1GBCFPssQ_3D4V3J	Ci7720QM	NLED18.4WUXGAGL	BROADWAY_PRO
AS8943G-724G1TMn	Eastern Europe	LX.PUH02.210	AS8943G_BROADWAY_PRO1GBCFPssQ_3D4V3J	Ci7720QM	NLED18.4WUXGAGL	BROADWAY_PRO
AS8943G-724G1TMn	Eastern Europe	LX.PUH02.209	AS8943G_BROADWAY_PRO1GBCFPssQ_3D4V3J	Ci7720QM	NLED18.4WUXGAGL	BROADWAY_PRO
AS8943G-724G1TMn	Eastern Europe	LX.PUH02.196	AS8943G_BROADWAY_PRO1GBCFPssQ_3D4V3J	Ci7720QM	NLED18.4WUXGAGL	BROADWAY_PRO
AS8943G-724G1TMn	Eastern Europe	LX.PUH02.195	AS8943G_BROADWAY_PRO1GBCFPssQ_3D4V3J	Ci7720QM	NLED18.4WUXGAGL	BROADWAY_PRO
AS8943G-724G1TMn	Eastern Europe	LX.PUH02.191	AS8943G_BROADWAY_PRO1GBCFPssQ_3D4V3J	Ci7720QM	NLED18.4WUXGAGL	BROADWAY_PRO
AS8943G-724G1TMn	France	LX.PUH02.192	AS8943G_BROADWAY_PRO1GBCFPssQ_3D4V3J	Ci7720QM	NLED18.4WUXGAGL	BROADWAY_PRO
AS8943G-724G1TMn	Germany	LX.PUH02.220	AS8943G_BROADWAY_PRO1GBCFPssQ_3D4V3J	Ci7720QM	NLED18.4WUXGAGL	BROADWAY_PRO
AS8943G-724G1TMn	Greece	LX.PUH02.194	AS8943G_BROADWAY_PRO1GBCFPssQ_3D4V3J	Ci7720QM	NLED18.4WUXGAGL	BROADWAY_PRO
AS8943G-724G1TMn	Holland	LX.PUH02.217	AS8943G_BROADWAY_PRO1GBCFPssQ_3D4V3J	Ci7720QM	NLED18.4WUXGAGL	BROADWAY_PRO
AS8943G-724G1TMn	Hungary	LX.PUH02.207	AS8943G_BROADWAY_PRO1GBCFPssQ_3D4V3J	Ci7720QM	NLED18.4WUXGAGL	BROADWAY_PRO
AS8943G-724G1TMn	Israel	LX.PUH02.206	AS8943G_BROADWAY_PRO1GBCFPssQ_3D4V3J	Ci7720QM	NLED18.4WUXGAGL	BROADWAY_PRO
AS8943G-724G1TMn	Italy	LX.PUH02.199	AS8943G_BROADWAY_PRO1GBCFPssQ_3D4V3J	Ci7720QM	NLED18.4WUXGAGL	BROADWAY_PRO
AS8943G-724G1TMn	Latvia	LX.PUH02.213	AS8943G_BROADWAY_PRO1GBCFPssQ_3D4V3J	Ci7720QM	NLED18.4WUXGAGL	BROADWAY_PRO

Model	Country	Acer P/N	BOM Name	CPU	LCD	VGA Chip
AS8943G-724G1TMn	Latvia	LX.PUH02.212	AS8943G_BROADWAY_PRO1GBCFPssQ_3D4V3J	Ci7720QM	NLED18.4WUXGAGL	BROADWAY_PRO
AS8943G-724G1TMn	Luxembourg	LX.PUH02.214	AS8943G_BROADWAY_PRO1GBCFPssQ_3D4V3J	Ci7720QM	NLED18.4WUXGAGL	BROADWAY_PRO
AS8943G-724G1TMn	Middle East	LX.PUH02.235	AS8943G_BROADWAY_PRO1GBCFPssQ_3D4V3J	Ci7720QM	NLED18.4WUXGAGL	BROADWAY_PRO
AS8943G-724G1TMn	Middle East	LX.PUH02.234	AS8943G_BROADWAY_PRO1GBCFPssQ_3D4V3J	Ci7720QM	NLED18.4WUXGAGL	BROADWAY_PRO
AS8943G-724G1TMn	Middle East	LX.PUH02.231	AS8943G_BROADWAY_PRO1GBCFPssQ_3D4V3J	Ci7720QM	NLED18.4WUXGAGL	BROADWAY_PRO
AS8943G-724G1TMn	Middle East	LX.PUH02.230	AS8943G_BROADWAY_PRO1GBCFPssQ_3D4V3J	Ci7720QM	NLED18.4WUXGAGL	BROADWAY_PRO
AS8943G-724G1TMn	Middle East	LX.PUH02.228	AS8943G_BROADWAY_PRO1GBCFPssQ_3D4V3J	Ci7720QM	NLED18.4WUXGAGL	BROADWAY_PRO
AS8943G-724G1TMn	Middle East	LX.PUH02.227	AS8943G_BROADWAY_PRO1GBCFPssQ_3D4V3J	Ci7720QM	NLED18.4WUXGAGL	BROADWAY_PRO
AS8943G-724G1TMn	Middle East	LX.PUH02.224	AS8943G_BROADWAY_PRO1GBCFPssQ_3D4V3J	Ci7720QM	NLED18.4WUXGAGL	BROADWAY_PRO
AS8943G-724G1TMn	Middle East	LX.PUH02.223	AS8943G_BROADWAY_PRO1GBCFPssQ_3D4V3J	Ci7720QM	NLED18.4WUXGAGL	BROADWAY_PRO
AS8943G-724G1TMn	Middle East	LX.PUH02.222	AS8943G_BROADWAY_PRO1GBCFPssQ_3D4V3J	Ci7720QM	NLED18.4WUXGAGL	BROADWAY_PRO
AS8943G-724G1TMn	Poland	LX.PUH02.219	AS8943G_BROADWAY_PRO1GBCFPssQ_3D4V3J	Ci7720QM	NLED18.4WUXGAGL	BROADWAY_PRO
AS8943G-724G1TMn	Portugal	LX.PUH02.204	AS8943G_BROADWAY_PRO1GBCFPssQ_3D4V3J	Ci7720QM	NLED18.4WUXGAGL	BROADWAY_PRO
AS8943G-724G1TMn	Serbia/Macedonia	LX.PUH02.201	AS8943G_BROADWAY_PRO1GBCFPssQ_3D4V3J	Ci7720QM	NLED18.4WUXGAGL	BROADWAY_PRO
AS8943G-724G1TMn	South Africa	LX.PUH02.233	AS8943G_BROADWAY_PRO1GBCFPssQ_3D4V3J	Ci7720QM	NLED18.4WUXGAGL	BROADWAY_PRO
AS8943G-724G1TMn	South Africa	LX.PUH02.229	AS8943G_BROADWAY_PRO1GBCFPssQ_3D4V3J	Ci7720QM	NLED18.4WUXGAGL	BROADWAY_PRO
AS8943G-724G1TMn	South Africa	LX.PUH02.225	AS8943G_BROADWAY_PRO1GBCFPssQ_3D4V3J	Ci7720QM	NLED18.4WUXGAGL	BROADWAY_PRO

Model	Country	Acer P/N	BOM Name	CPU	LCD	VGA Chip
AS8943G-724G1TMn	South Africa	LX.PUH02.221	AS8943G_BROADWAY_PRO1GBCFPssQ_3D4V3J	Ci7720QM	NLED18.4 WUXGAGL	BROADWAY_PRO
AS8943G-724G1TMn	Spain	LX.PUH02.198	AS8943G_BROADWAY_PRO1GBCFPssQ_3D4V3J	Ci7720QM	NLED18.4 WUXGAGL	BROADWAY_PRO
AS8943G-724G1TMn	Switzerland	LX.PUH02.215	AS8943G_BROADWAY_PRO1GBCFPssQ_3D4V3J	Ci7720QM	NLED18.4 WUXGAGL	BROADWAY_PRO
AS8943G-724G1TMn	Turkey	LX.PUH02.232	AS8943G_BROADWAY_PRO1GBCFPssQ_3D4V3J	Ci7720QM	NLED18.4 WUXGAGL	BROADWAY_PRO
AS8943G-724G1TMn	UK	LX.PUH02.211	AS8943G_BROADWAY_PRO1GBCFPssQ_3D4V3J	Ci7720QM	NLED18.4 WUXGAGL	BROADWAY_PRO
AS8943G-724G1TWn	Hong Kong	LX.PUH02.238	AS8943G_BROADWAY_PRO1GBCFPssQ_3D4V3J	Ci7720QM	NLED18.4 WUXGAGL	BROADWAY_PRO
AS8943G-724G50Bn	USA	LX.PWC0.2.074	AS8943G_MADISON_PRO1GBCFPssQ_3D4V3J	Ci7720QM	NLED18.4 WUXGAGL	MADISON_PRO
AS8943G-724G50Mn	USA	LX.PWC0.2.070	AS8943G_MADISON_PRO1GBCFPssQ_3D4V3J	Ci7720QM	NLED18.4 WUXGAGL	MADISON_PRO
AS8943G-724G64Bn	Middle East	LX.PWC0.2.069	AS8943G_MADISON_PRO1GBCFPssQ_3D4V3J	Ci7720QM	NLED18.4 WUXGAGL	MADISON_PRO
AS8943G-724G64Bn	UK	LX.PWC0.2.076	AS8943G_MADISON_PRO1GBCFPssQ_3D4V3J	Ci7720QM	NLED18.4 WUXGAGL	MADISON_PRO
AS8943G-724G64Mi	Russia	LX.PWC0.2.066	AS8943G_MADISON_PRO1GBCFPssQ_3D4V3J	Ci7720QM	NLED18.4 WUXGAGL	MADISON_PRO
AS8943G-724G64Mi	Russia	LX.PUH02.045	AS8943G_BROADWAY_PRO1GBCFPssQ_3D4V3J	Ci7720QM	NLED18.4 WUXGAGL	BROADWAY_PRO
AS8943G-724G64Mn	Algeria	LX.PWC0.2.047	AS8943G_MADISON_PRO1GBCFPssQ_3D4V3J	Ci7720QM	NLED18.4 WUXGAGL	MADISON_PRO
AS8943G-724G64Mn	Algeria	LX.PUH02.037	AS8943G_BROADWAY_PRO1GBCFPssQ_3D4V3J	Ci7720QM	NLED18.4 WUXGAGL	BROADWAY_PRO
AS8943G-724G64Mn	Austria	LX.PWC0.2.005	AS8943G_MADISON_PRO1GBCFPssQ_3D4V3J	Ci7720QM	NLED18.4 WUXGAGL	MADISON_PRO
AS8943G-724G64Mn	Austria	LX.PUH02.009	AS8943G_BROADWAY_PRO1GBCFPssQ_3D4V3J	Ci7720QM	NLED18.4 WUXGAGL	BROADWAY_PRO
AS8943G-724G64Mn	Baltic	LX.PWC0.2.058	AS8943G_MADISON_PRO1GBCFPssQ_3D4V3J	Ci7720QM	NLED18.4 WUXGAGL	MADISON_PRO

Model	Country	Acer P/N	BOM Name	CPU	LCD	VGA Chip
AS8943G-724G64Mn	Baltic	LX.PWC0 2.027	AS8943G_MADISON_PRO1GBCFPssQ_3D4V3J	Ci7720QM	NLED18.4 WUXGAGL	MADISON_PRO
AS8943G-724G64Mn	Baltic	LX.PWC0 2.024	AS8943G_MADISON_PRO1GBCFPssQ_3D4V3J	Ci7720QM	NLED18.4 WUXGAGL	MADISON_PRO
AS8943G-724G64Mn	Baltic	LX.PUH02 .028	AS8943G_BROADWAY_PRO1GBCFPssQ_3D4V3J	Ci7720QM	NLED18.4 WUXGAGL	BROADWAY_PRO
AS8943G-724G64Mn	Baltic	LX.PUH02 .020	AS8943G_BROADWAY_PRO1GBCFPssQ_3D4V3J	Ci7720QM	NLED18.4 WUXGAGL	BROADWAY_PRO
AS8943G-724G64Mn	Baltic	LX.PUH02 .017	AS8943G_BROADWAY_PRO1GBCFPssQ_3D4V3J	Ci7720QM	NLED18.4 WUXGAGL	BROADWAY_PRO
AS8943G-724G64Mn	Belgium	LX.PWC0 2.055	AS8943G_MADISON_PRO1GBCFPssQ_3D4V3J	Ci7720QM	NLED18.4 WUXGAGL	MADISON_PRO
AS8943G-724G64Mn	Belgium	LX.PUH02 .025	AS8943G_BROADWAY_PRO1GBCFPssQ_3D4V3J	Ci7720QM	NLED18.4 WUXGAGL	BROADWAY_PRO
AS8943G-724G64Mn	China	LX.PUH02 .001	AS8943G_BROADWAY_PRO1GBCFPssQ_3D4V3J	Ci7720QM	NLED18.4 WUXGAGL	BROADWAY_PRO
AS8943G-724G64Mn	Cyprus	LX.PWC0 2.025	AS8943G_MADISON_PRO1GBCFPssQ_3D4V3J	Ci7720QM	NLED18.4 WUXGAGL	MADISON_PRO
AS8943G-724G64Mn	Cyprus	LX.PUH02 .019	AS8943G_BROADWAY_PRO1GBCFPssQ_3D4V3J	Ci7720QM	NLED18.4 WUXGAGL	BROADWAY_PRO
AS8943G-724G64Mn	Czech	LX.PWC0 2.030	AS8943G_MADISON_PRO1GBCFPssQ_3D4V3J	Ci7720QM	NLED18.4 WUXGAGL	MADISON_PRO
AS8943G-724G64Mn	Czech	LX.PUH02 .004	AS8943G_BROADWAY_PRO1GBCFPssQ_3D4V3J	Ci7720QM	NLED18.4 WUXGAGL	BROADWAY_PRO
AS8943G-724G64Mn	Denmark	LX.PWC0 2.012	AS8943G_MADISON_PRO1GBCFPssQ_3D4V3J	Ci7720QM	NLED18.4 WUXGAGL	MADISON_PRO
AS8943G-724G64Mn	Denmark	LX.PUH02 .015	AS8943G_BROADWAY_PRO1GBCFPssQ_3D4V3J	Ci7720QM	NLED18.4 WUXGAGL	BROADWAY_PRO
AS8943G-724G64Mn	Eastern Europe	LX.PWC0 2.040	AS8943G_MADISON_PRO1GBCFPssQ_3D4V3J	Ci7720QM	NLED18.4 WUXGAGL	MADISON_PRO
AS8943G-724G64Mn	Eastern Europe	LX.PWC0 2.037	AS8943G_MADISON_PRO1GBCFPssQ_3D4V3J	Ci7720QM	NLED18.4 WUXGAGL	MADISON_PRO
AS8943G-724G64Mn	Eastern Europe	LX.PWC0 2.011	AS8943G_MADISON_PRO1GBCFPssQ_3D4V3J	Ci7720QM	NLED18.4 WUXGAGL	MADISON_PRO

Model	Country	Acer P/N	BOM Name	CPU	LCD	VGA Chip
AS8943G-724G64Mn	Eastern Europe	LX.PWC0 2.008	AS8943G_MADISON_PRO1GBCFPssQ_3D4V3J	Ci7720QM	NLED18.4 WUXGAGL	MADISON_PRO
AS8943G-724G64Mn	Eastern Europe	LX.PWC0 2.001	AS8943G_MADISON_PRO1GBCFPssQ_3D4V3J	Ci7720QM	NLED18.4 WUXGAGL	MADISON_PRO
AS8943G-724G64Mn	Eastern Europe	LX.PUH02 .021	AS8943G_BROADWAY_PRO1GBCFPssQ_3D4V3J	Ci7720QM	NLED18.4 WUXGAGL	BROADWAY_PRO
AS8943G-724G64Mn	Eastern Europe	LX.PUH02 .014	AS8943G_BROADWAY_PRO1GBCFPssQ_3D4V3J	Ci7720QM	NLED18.4 WUXGAGL	BROADWAY_PRO
AS8943G-724G64Mn	Eastern Europe	LX.PUH02 .013	AS8943G_BROADWAY_PRO1GBCFPssQ_3D4V3J	Ci7720QM	NLED18.4 WUXGAGL	BROADWAY_PRO
AS8943G-724G64Mn	Eastern Europe	LX.PUH02 .008	AS8943G_BROADWAY_PRO1GBCFPssQ_3D4V3J	Ci7720QM	NLED18.4 WUXGAGL	BROADWAY_PRO
AS8943G-724G64Mn	Eastern Europe	LX.PUH02 .006	AS8943G_BROADWAY_PRO1GBCFPssQ_3D4V3J	Ci7720QM	NLED18.4 WUXGAGL	BROADWAY_PRO
AS8943G-724G64Mn	France	LX.PWC0 2.004	AS8943G_MADISON_PRO1GBCFPssQ_3D4V3J	Ci7720QM	NLED18.4 WUXGAGL	MADISON_PRO
AS8943G-724G64Mn	France	LX.PUH02 .007	AS8943G_BROADWAY_PRO1GBCFPssQ_3D4V3J	Ci7720QM	NLED18.4 WUXGAGL	BROADWAY_PRO
AS8943G-724G64Mn	Germany	LX.PWC0 2.061	AS8943G_MADISON_PRO1GBCFPssQ_3D4V3J	Ci7720QM	NLED18.4 WUXGAGL	MADISON_PRO
AS8943G-724G64Mn	Germany	LX.PUH02 .029	AS8943G_BROADWAY_PRO1GBCFPssQ_3D4V3J	Ci7720QM	NLED18.4 WUXGAGL	BROADWAY_PRO
AS8943G-724G64Mn	Greece	LX.PWC0 2.007	AS8943G_MADISON_PRO1GBCFPssQ_3D4V3J	Ci7720QM	NLED18.4 WUXGAGL	MADISON_PRO
AS8943G-724G64Mn	Greece	LX.PUH02 .010	AS8943G_BROADWAY_PRO1GBCFPssQ_3D4V3J	Ci7720QM	NLED18.4 WUXGAGL	BROADWAY_PRO
AS8943G-724G64Mn	Holland	LX.PWC0 2.056	AS8943G_MADISON_PRO1GBCFPssQ_3D4V3J	Ci7720QM	NLED18.4 WUXGAGL	MADISON_PRO
AS8943G-724G64Mn	Holland	LX.PUH02 .026	AS8943G_BROADWAY_PRO1GBCFPssQ_3D4V3J	Ci7720QM	NLED18.4 WUXGAGL	BROADWAY_PRO
AS8943G-724G64Mn	Hungary	LX.PWC0 2.029	AS8943G_MADISON_PRO1GBCFPssQ_3D4V3J	Ci7720QM	NLED18.4 WUXGAGL	MADISON_PRO
AS8943G-724G64Mn	Hungary	LX.PUH02 .003	AS8943G_BROADWAY_PRO1GBCFPssQ_3D4V3J	Ci7720QM	NLED18.4 WUXGAGL	BROADWAY_PRO

Model	Country	Acer P/N	BOM Name	CPU	LCD	VGA Chip
AS8943G-724G64Mn	Israel	LX.PWC0 2.028	AS8943G_MADISON_PRO1GBCFPssQ_3D4V3J	Ci7720QM	NLED18.4 WUXGAGL	MADISON_PRO
AS8943G-724G64Mn	Israel	LX.PUH02 .002	AS8943G_BROADWAY_PRO1GBCFPssQ_3D4V3J	Ci7720QM	NLED18.4 WUXGAGL	BROADWAY_PRO
AS8943G-724G64Mn	Italy	LX.PWC0 2.018	AS8943G_MADISON_PRO1GBCFPssQ_3D4V3J	Ci7720QM	NLED18.4 WUXGAGL	MADISON_PRO
AS8943G-724G64Mn	Italy	LX.PUH02 .012	AS8943G_BROADWAY_PRO1GBCFPssQ_3D4V3J	Ci7720QM	NLED18.4 WUXGAGL	BROADWAY_PRO
AS8943G-724G64Mn	Latvia	LX.PWC0 2.043	AS8943G_MADISON_PRO1GBCFPssQ_3D4V3J	Ci7720QM	NLED18.4 WUXGAGL	MADISON_PRO
AS8943G-724G64Mn	Latvia	LX.PWC0 2.042	AS8943G_MADISON_PRO1GBCFPssQ_3D4V3J	Ci7720QM	NLED18.4 WUXGAGL	MADISON_PRO
AS8943G-724G64Mn	Latvia	LX.PUH02 .023	AS8943G_BROADWAY_PRO1GBCFPssQ_3D4V3J	Ci7720QM	NLED18.4 WUXGAGL	BROADWAY_PRO
AS8943G-724G64Mn	Latvia	LX.PUH02 .022	AS8943G_BROADWAY_PRO1GBCFPssQ_3D4V3J	Ci7720QM	NLED18.4 WUXGAGL	BROADWAY_PRO
AS8943G-724G64Mn	Luxembourg	LX.PWC0 2.044	AS8943G_MADISON_PRO1GBCFPssQ_3D4V3J	Ci7720QM	NLED18.4 WUXGAGL	MADISON_PRO
AS8943G-724G64Mn	Luxembourg	LX.PUH02 .027	AS8943G_BROADWAY_PRO1GBCFPssQ_3D4V3J	Ci7720QM	NLED18.4 WUXGAGL	BROADWAY_PRO
AS8943G-724G64Mn	Middle East	LX.PWC0 2.065	AS8943G_MADISON_PRO1GBCFPssQ_3D4V3J	Ci7720QM	NLED18.4 WUXGAGL	MADISON_PRO
AS8943G-724G64Mn	Middle East	LX.PWC0 2.064	AS8943G_MADISON_PRO1GBCFPssQ_3D4V3J	Ci7720QM	NLED18.4 WUXGAGL	MADISON_PRO
AS8943G-724G64Mn	Middle East	LX.PWC0 2.051	AS8943G_MADISON_PRO1GBCFPssQ_3D4V3J	Ci7720QM	NLED18.4 WUXGAGL	MADISON_PRO
AS8943G-724G64Mn	Middle East	LX.PWC0 2.050	AS8943G_MADISON_PRO1GBCFPssQ_3D4V3J	Ci7720QM	NLED18.4 WUXGAGL	MADISON_PRO
AS8943G-724G64Mn	Middle East	LX.PWC0 2.048	AS8943G_MADISON_PRO1GBCFPssQ_3D4V3J	Ci7720QM	NLED18.4 WUXGAGL	MADISON_PRO
AS8943G-724G64Mn	Middle East	LX.PWC0 2.035	AS8943G_MADISON_PRO1GBCFPssQ_3D4V3J	Ci7720QM	NLED18.4 WUXGAGL	MADISON_PRO
AS8943G-724G64Mn	Middle East	LX.PWC0 2.034	AS8943G_MADISON_PRO1GBCFPssQ_3D4V3J	Ci7720QM	NLED18.4 WUXGAGL	MADISON_PRO

Model	Country	Acer P/N	BOM Name	CPU	LCD	VGA Chip
AS8943G-724G64Mn	Middle East	LX.PWC0 2.033	AS8943G_MADISON_PRO1GBCFPssQ_3D4V3J	Ci7720QM	NLED18.4 WUXGAGL	MADISON_PRO
AS8943G-724G64Mn	Middle East	LX.PWC0 2.032	AS8943G_MADISON_PRO1GBCFPssQ_3D4V3J	Ci7720QM	NLED18.4 WUXGAGL	MADISON_PRO
AS8943G-724G64Mn	Middle East	LX.PUH02 .044	AS8943G_BROADWAY_PRO1GBCFPssQ_3D4V3J	Ci7720QM	NLED18.4 WUXGAGL	BROADWAY_PRO
AS8943G-724G64Mn	Middle East	LX.PUH02 .043	AS8943G_BROADWAY_PRO1GBCFPssQ_3D4V3J	Ci7720QM	NLED18.4 WUXGAGL	BROADWAY_PRO
AS8943G-724G64Mn	Middle East	LX.PUH02 .040	AS8943G_BROADWAY_PRO1GBCFPssQ_3D4V3J	Ci7720QM	NLED18.4 WUXGAGL	BROADWAY_PRO
AS8943G-724G64Mn	Middle East	LX.PUH02 .039	AS8943G_BROADWAY_PRO1GBCFPssQ_3D4V3J	Ci7720QM	NLED18.4 WUXGAGL	BROADWAY_PRO
AS8943G-724G64Mn	Middle East	LX.PUH02 .038	AS8943G_BROADWAY_PRO1GBCFPssQ_3D4V3J	Ci7720QM	NLED18.4 WUXGAGL	BROADWAY_PRO
AS8943G-724G64Mn	Middle East	LX.PUH02 .035	AS8943G_BROADWAY_PRO1GBCFPssQ_3D4V3J	Ci7720QM	NLED18.4 WUXGAGL	BROADWAY_PRO
AS8943G-724G64Mn	Middle East	LX.PUH02 .034	AS8943G_BROADWAY_PRO1GBCFPssQ_3D4V3J	Ci7720QM	NLED18.4 WUXGAGL	BROADWAY_PRO
AS8943G-724G64Mn	Middle East	LX.PUH02 .033	AS8943G_BROADWAY_PRO1GBCFPssQ_3D4V3J	Ci7720QM	NLED18.4 WUXGAGL	BROADWAY_PRO
AS8943G-724G64Mn	Middle East	LX.PUH02 .032	AS8943G_BROADWAY_PRO1GBCFPssQ_3D4V3J	Ci7720QM	NLED18.4 WUXGAGL	BROADWAY_PRO
AS8943G-724G64Mn	Poland	LX.PWC0 2.059	AS8943G_MADISON_PRO1GBCFPssQ_3D4V3J	Ci7720QM	NLED18.4 WUXGAGL	MADISON_PRO
AS8943G-724G64Mn	Poland	LX.PUH02 .030	AS8943G_BROADWAY_PRO1GBCFPssQ_3D4V3J	Ci7720QM	NLED18.4 WUXGAGL	BROADWAY_PRO
AS8943G-724G64Mn	Portugal	LX.PWC0 2.026	AS8943G_MADISON_PRO1GBCFPssQ_3D4V3J	Ci7720QM	NLED18.4 WUXGAGL	MADISON_PRO
AS8943G-724G64Mn	Portugal	LX.PUH02 .018	AS8943G_BROADWAY_PRO1GBCFPssQ_3D4V3J	Ci7720QM	NLED18.4 WUXGAGL	BROADWAY_PRO
AS8943G-724G64Mn	Serbia/Macedonia	LX.PWC0 2.019	AS8943G_MADISON_PRO1GBCFPssQ_3D4V3J	Ci7720QM	NLED18.4 WUXGAGL	MADISON_PRO
AS8943G-724G64Mn	Serbia/Macedonia	LX.PUH02 .016	AS8943G_BROADWAY_PRO1GBCFPssQ_3D4V3J	Ci7720QM	NLED18.4 WUXGAGL	BROADWAY_PRO

Model	Country	Acer P/N	BOM Name	CPU	LCD	VGA Chip
AS8943G-724G64Mn	South Africa	LX.PWC0 2.063	AS8943G_MADISON_PRO1GBCFPssQ_3D4V3J	Ci7720QM	NLED18.4 WUXGAGL	MADISON_PRO
AS8943G-724G64Mn	South Africa	LX.PWC0 2.049	AS8943G_MADISON_PRO1GBCFPssQ_3D4V3J	Ci7720QM	NLED18.4 WUXGAGL	MADISON_PRO
AS8943G-724G64Mn	South Africa	LX.PWC0 2.046	AS8943G_MADISON_PRO1GBCFPssQ_3D4V3J	Ci7720QM	NLED18.4 WUXGAGL	MADISON_PRO
AS8943G-724G64Mn	South Africa	LX.PWC0 2.031	AS8943G_MADISON_PRO1GBCFPssQ_3D4V3J	Ci7720QM	NLED18.4 WUXGAGL	MADISON_PRO
AS8943G-724G64Mn	South Africa	LX.PUH02 .042	AS8943G_BROADWAY_PRO1GBCFPssQ_3D4V3J	Ci7720QM	NLED18.4 WUXGAGL	BROADWAY_PRO
AS8943G-724G64Mn	South Africa	LX.PUH02 .036	AS8943G_BROADWAY_PRO1GBCFPssQ_3D4V3J	Ci7720QM	NLED18.4 WUXGAGL	BROADWAY_PRO
AS8943G-724G64Mn	South Africa	LX.PUH02 .031	AS8943G_BROADWAY_PRO1GBCFPssQ_3D4V3J	Ci7720QM	NLED18.4 WUXGAGL	BROADWAY_PRO
AS8943G-724G64Mn	Spain	LX.PWC0 2.015	AS8943G_MADISON_PRO1GBCFPssQ_3D4V3J	Ci7720QM	NLED18.4 WUXGAGL	MADISON_PRO
AS8943G-724G64Mn	Spain	LX.PUH02 .011	AS8943G_BROADWAY_PRO1GBCFPssQ_3D4V3J	Ci7720QM	NLED18.4 WUXGAGL	BROADWAY_PRO
AS8943G-724G64Mn	Switzerland	LX.PWC0 2.045	AS8943G_MADISON_PRO1GBCFPssQ_3D4V3J	Ci7720QM	NLED18.4 WUXGAGL	MADISON_PRO
AS8943G-724G64Mn	Switzerland	LX.PUH02 .024	AS8943G_BROADWAY_PRO1GBCFPssQ_3D4V3J	Ci7720QM	NLED18.4 WUXGAGL	BROADWAY_PRO
AS8943G-724G64Mn	Turkey	LX.PWC0 2.062	AS8943G_MADISON_PRO1GBCFPssQ_3D4V3J	Ci7720QM	NLED18.4 WUXGAGL	MADISON_PRO
AS8943G-724G64Mn	Turkey	LX.PUH02 .041	AS8943G_BROADWAY_PRO1GBCFPssQ_3D4V3J	Ci7720QM	NLED18.4 WUXGAGL	BROADWAY_PRO
AS8943G-724G64Mn	UK	LX.PWC0 2.041	AS8943G_MADISON_PRO1GBCFPssQ_3D4V3J	Ci7720QM	NLED18.4 WUXGAGL	MADISON_PRO
AS8943G-724G64Mn	UK	LX.PUH02 .005	AS8943G_BROADWAY_PRO1GBCFPssQ_3D4V3J	Ci7720QM	NLED18.4 WUXGAGL	BROADWAY_PRO
AS8943G-724G64Mn	Ukraine	LX.PWC0 2.067	AS8943G_MADISON_PRO1GBCFPssQ_3D4V3J	Ci7720QM	NLED18.4 WUXGAGL	MADISON_PRO
AS8943G-724G64Mn	Ukraine	LX.PUH02 .046	AS8943G_BROADWAY_PRO1GBCFPssQ_3D4V3J	Ci7720QM	NLED18.4 WUXGAGL	BROADWAY_PRO

Model	Country	Acer P/N	BOM Name	CPU	LCD	VGA Chip
AS8943G-724G64Wn	China	LX.PUH02.237	AS8943G_BROADWAY_PRO1GBCFPssQ_3D4V3J	Ci7720QM	NLED18.4 WUXGAGL	BROADWAY_PRO
AS8943G-724G64Wn	Middle East	LX.PWC02.068	AS8943G_MADISON_PRO1GBCFPssQ_3D4V3J	Ci7720QM	NLED18.4 WUXGAGL	MADISON_PRO
AS8943G-726G1.28TBn	Belgium	LX.PWC02.071	AS8943G_MADISON_PRO1GBCFPssQ_3D4V3J	Ci7720QM	NLED18.4 WUXGAGL	MADISON_PRO
AS8943G-726G1.28TBn	Belgium	LX.PUH02.241	AS8943G_BROADWAY_PRO1GBCFPssQ_3D4V3J	Ci7720QM	NLED18.4 WUXGAGL	BROADWAY_PRO
AS8943G-726G1.28TBn	Holland	LX.PWC02.073	AS8943G_MADISON_PRO1GBCFPssQ_3D4V3J	Ci7720QM	NLED18.4 WUXGAGL	MADISON_PRO
AS8943G-726G1.28TBn	Holland	LX.PUH02.240	AS8943G_BROADWAY_PRO1GBCFPssQ_3D4V3J	Ci7720QM	NLED18.4 WUXGAGL	BROADWAY_PRO
AS8943G-726G1.28TBn	Luxembourg	LX.PWC02.072	AS8943G_MADISON_PRO1GBCFPssQ_3D4V3J	Ci7720QM	NLED18.4 WUXGAGL	MADISON_PRO
AS8943G-726G1.28TBn	Luxembourg	LX.PUH02.242	AS8943G_BROADWAY_PRO1GBCFPssQ_3D4V3J	Ci7720QM	NLED18.4 WUXGAGL	BROADWAY_PRO
AS8943G-726G64Wn	Australia/New Zealand	LX.PUG02.006	AS8943G_BROADWAY_PRO1GBTCFPssQ_3D4V3J	Ci7720QM	NLED18.4 WUXGAGL	BROADWAY_PRO
AS8943G-728G1.14TBn	Spain	LX.PUG02.001	AS8943G_BROADWAY_PRO1GBTCFPssQ_3D4V3J	Ci7720QM	NLED18.4 WUXGAGL	BROADWAY_PRO
AS8943G-728G1.28TBn	Algeria	LX.PUH02.173	AS8943G_BROADWAY_PRO1GBCFPssQ_3D4V3J	Ci7720QM	NLED18.4 WUXGAGL	BROADWAY_PRO
AS8943G-728G1.28TBn	Austria	LX.PUH02.140	AS8943G_BROADWAY_PRO1GBCFPssQ_3D4V3J	Ci7720QM	NLED18.4 WUXGAGL	BROADWAY_PRO
AS8943G-728G1.28TBn	Baltic	LX.PUH02.164	AS8943G_BROADWAY_PRO1GBCFPssQ_3D4V3J	Ci7720QM	NLED18.4 WUXGAGL	BROADWAY_PRO
AS8943G-728G1.28TBn	Baltic	LX.PUH02.151	AS8943G_BROADWAY_PRO1GBCFPssQ_3D4V3J	Ci7720QM	NLED18.4 WUXGAGL	BROADWAY_PRO
AS8943G-728G1.28TBn	Baltic	LX.PUH02.148	AS8943G_BROADWAY_PRO1GBCFPssQ_3D4V3J	Ci7720QM	NLED18.4 WUXGAGL	BROADWAY_PRO
AS8943G-728G1.28TBn	Belgium	LX.PUH02.161	AS8943G_BROADWAY_PRO1GBCFPssQ_3D4V3J	Ci7720QM	NLED18.4 WUXGAGL	BROADWAY_PRO
AS8943G-728G1.28TBn	Cyprus	LX.PUH02.150	AS8943G_BROADWAY_PRO1GBCFPssQ_3D4V3J	Ci7720QM	NLED18.4 WUXGAGL	BROADWAY_PRO

Model	Country	Acer P/N	BOM Name	CPU	LCD	VGA Chip
AS8943G-728G1.28 TBn	Czech	LX.PUH02 .154	AS8943G_BROADWAY_PRO1GBCFPssQ_3D4V3J	Ci7720QM	NLED18.4 WUXGAGL	BROADWAY_PRO
AS8943G-728G1.28 TBn	Denmark	LX.PUH02 .146	AS8943G_BROADWAY_PRO1GBCFPssQ_3D4V3J	Ci7720QM	NLED18.4 WUXGAGL	BROADWAY_PRO
AS8943G-728G1.28 TBn	Eastern Europe	LX.PUH02 .157	AS8943G_BROADWAY_PRO1GBCFPssQ_3D4V3J	Ci7720QM	NLED18.4 WUXGAGL	BROADWAY_PRO
AS8943G-728G1.28 TBn	Eastern Europe	LX.PUH02 .156	AS8943G_BROADWAY_PRO1GBCFPssQ_3D4V3J	Ci7720QM	NLED18.4 WUXGAGL	BROADWAY_PRO
AS8943G-728G1.28 TBn	Eastern Europe	LX.PUH02 .145	AS8943G_BROADWAY_PRO1GBCFPssQ_3D4V3J	Ci7720QM	NLED18.4 WUXGAGL	BROADWAY_PRO
AS8943G-728G1.28 TBn	Eastern Europe	LX.PUH02 .144	AS8943G_BROADWAY_PRO1GBCFPssQ_3D4V3J	Ci7720QM	NLED18.4 WUXGAGL	BROADWAY_PRO
AS8943G-728G1.28 TBn	Eastern Europe	LX.PUH02 .139	AS8943G_BROADWAY_PRO1GBCFPssQ_3D4V3J	Ci7720QM	NLED18.4 WUXGAGL	BROADWAY_PRO
AS8943G-728G1.28 TBn	France	LX.PUH02 .138	AS8943G_BROADWAY_PRO1GBCFPssQ_3D4V3J	Ci7720QM	NLED18.4 WUXGAGL	BROADWAY_PRO
AS8943G-728G1.28 TBn	Germany	LX.PUH02 .165	AS8943G_BROADWAY_PRO1GBCFPssQ_3D4V3J	Ci7720QM	NLED18.4 WUXGAGL	BROADWAY_PRO
AS8943G-728G1.28 TBn	Greece	LX.PUH02 .141	AS8943G_BROADWAY_PRO1GBCFPssQ_3D4V3J	Ci7720QM	NLED18.4 WUXGAGL	BROADWAY_PRO
AS8943G-728G1.28 TBn	Holland	LX.PUH02 .162	AS8943G_BROADWAY_PRO1GBCFPssQ_3D4V3J	Ci7720QM	NLED18.4 WUXGAGL	BROADWAY_PRO
AS8943G-728G1.28 TBn	Hungary	LX.PUH02 .153	AS8943G_BROADWAY_PRO1GBCFPssQ_3D4V3J	Ci7720QM	NLED18.4 WUXGAGL	BROADWAY_PRO
AS8943G-728G1.28 TBn	Israel	LX.PUH02 .152	AS8943G_BROADWAY_PRO1GBCFPssQ_3D4V3J	Ci7720QM	NLED18.4 WUXGAGL	BROADWAY_PRO
AS8943G-728G1.28 TBn	Italy	LX.PUH02 .143	AS8943G_BROADWAY_PRO1GBCFPssQ_3D4V3J	Ci7720QM	NLED18.4 WUXGAGL	BROADWAY_PRO
AS8943G-728G1.28 TBn	Latvia	LX.PUH02 .159	AS8943G_BROADWAY_PRO1GBCFPssQ_3D4V3J	Ci7720QM	NLED18.4 WUXGAGL	BROADWAY_PRO
AS8943G-728G1.28 TBn	Latvia	LX.PUH02 .158	AS8943G_BROADWAY_PRO1GBCFPssQ_3D4V3J	Ci7720QM	NLED18.4 WUXGAGL	BROADWAY_PRO
AS8943G-728G1.28 TBn	Luxembourg	LX.PUH02 .163	AS8943G_BROADWAY_PRO1GBCFPssQ_3D4V3J	Ci7720QM	NLED18.4 WUXGAGL	BROADWAY_PRO

Model	Country	Acer P/N	BOM Name	CPU	LCD	VGA Chip
AS8943G-728G1.28 TBn	Middle East	LX.PUH02 .180	AS8943G_BROADWAY_PRO1GBC FPssQ_3D4V3J	Ci7720QM	NLED18.4 WUXGAGL	BROADWAY_PRO
AS8943G-728G1.28 TBn	Middle East	LX.PUH02 .179	AS8943G_BROADWAY_PRO1GBC FPssQ_3D4V3J	Ci7720QM	NLED18.4 WUXGAGL	BROADWAY_PRO
AS8943G-728G1.28 TBn	Middle East	LX.PUH02 .176	AS8943G_BROADWAY_PRO1GBC FPssQ_3D4V3J	Ci7720QM	NLED18.4 WUXGAGL	BROADWAY_PRO
AS8943G-728G1.28 TBn	Middle East	LX.PUH02 .175	AS8943G_BROADWAY_PRO1GBC FPssQ_3D4V3J	Ci7720QM	NLED18.4 WUXGAGL	BROADWAY_PRO
AS8943G-728G1.28 TBn	Middle East	LX.PUH02 .174	AS8943G_BROADWAY_PRO1GBC FPssQ_3D4V3J	Ci7720QM	NLED18.4 WUXGAGL	BROADWAY_PRO
AS8943G-728G1.28 TBn	Middle East	LX.PUH02 .171	AS8943G_BROADWAY_PRO1GBC FPssQ_3D4V3J	Ci7720QM	NLED18.4 WUXGAGL	BROADWAY_PRO
AS8943G-728G1.28 TBn	Middle East	LX.PUH02 .170	AS8943G_BROADWAY_PRO1GBC FPssQ_3D4V3J	Ci7720QM	NLED18.4 WUXGAGL	BROADWAY_PRO
AS8943G-728G1.28 TBn	Middle East	LX.PUH02 .169	AS8943G_BROADWAY_PRO1GBC FPssQ_3D4V3J	Ci7720QM	NLED18.4 WUXGAGL	BROADWAY_PRO
AS8943G-728G1.28 TBn	Middle East	LX.PUH02 .168	AS8943G_BROADWAY_PRO1GBC FPssQ_3D4V3J	Ci7720QM	NLED18.4 WUXGAGL	BROADWAY_PRO
AS8943G-728G1.28 TBn	Poland	LX.PUH02 .166	AS8943G_BROADWAY_PRO1GBC FPssQ_3D4V3J	Ci7720QM	NLED18.4 WUXGAGL	BROADWAY_PRO
AS8943G-728G1.28 TBn	Portugal	LX.PUH02 .149	AS8943G_BROADWAY_PRO1GBC FPssQ_3D4V3J	Ci7720QM	NLED18.4 WUXGAGL	BROADWAY_PRO
AS8943G-728G1.28 TBn	Serbia/Macedonia	LX.PUH02 .147	AS8943G_BROADWAY_PRO1GBC FPssQ_3D4V3J	Ci7720QM	NLED18.4 WUXGAGL	BROADWAY_PRO
AS8943G-728G1.28 TBn	South Africa	LX.PUH02 .178	AS8943G_BROADWAY_PRO1GBC FPssQ_3D4V3J	Ci7720QM	NLED18.4 WUXGAGL	BROADWAY_PRO
AS8943G-728G1.28 TBn	South Africa	LX.PUH02 .172	AS8943G_BROADWAY_PRO1GBC FPssQ_3D4V3J	Ci7720QM	NLED18.4 WUXGAGL	BROADWAY_PRO
AS8943G-728G1.28 TBn	South Africa	LX.PUH02 .167	AS8943G_BROADWAY_PRO1GBC FPssQ_3D4V3J	Ci7720QM	NLED18.4 WUXGAGL	BROADWAY_PRO
AS8943G-728G1.28 TBn	Spain	LX.PUH02 .142	AS8943G_BROADWAY_PRO1GBC FPssQ_3D4V3J	Ci7720QM	NLED18.4 WUXGAGL	BROADWAY_PRO
AS8943G-728G1.28 TBn	Switzerland	LX.PUH02 .160	AS8943G_BROADWAY_PRO1GBC FPssQ_3D4V3J	Ci7720QM	NLED18.4 WUXGAGL	BROADWAY_PRO

Model	Country	Acer P/N	BOM Name	CPU	LCD	VGA Chip
AS8943G-728G1.28 TBn	Turkey	LX.PUH02 .177	AS8943G_BROADWAY_PRO1GBC FPssQ_3D4V3J	Ci7720QM	NLED18.4 WUXGAGL	BROADWAY_PRO
AS8943G-728G1.28 TBn	UK	LX.PUH02 .155	AS8943G_BROADWAY_PRO1GBC FPssQ_3D4V3J	Ci7720QM	NLED18.4 WUXGAGL	BROADWAY_PRO
AS8943G-728G1.28 TWi	Russia	LX.PUH02 .254	AS8943G_BROADWAY_PRO1GBC FPssQ_3D4V3J	Ci7720QM	NLED18.4 WUXGAGL	BROADWAY_PRO
AS8943G-728G1.28 TWn	Australia/ New Zealand	LX.PUG02 .007	AS8943G_BROADWAY_PRO1GBT CFPssQ_3D4V3J	Ci7720QM	NLED18.4 WUXGAGL	BROADWAY_PRO
AS8943G-728G1.28 TWn	Czech	LX.PUG02 .011	AS8943G_BROADWAY_PRO1GBT CFPssQ_3D4V3J	Ci7720QM	NLED18.4 WUXGAGL	BROADWAY_PRO
AS8943G-728G1.28 TWn	France	LX.PUG02 .004	AS8943G_BROADWAY_PRO1GBT CFPssQ_3D4V3J	Ci7720QM	NLED18.4 WUXGAGL	BROADWAY_PRO
AS8943G-728G1.28 TWn	Germany	LX.PUH02 .251	AS8943G_BROADWAY_PRO1GBC FPssQ_3D4V3J	Ci7720QM	NLED18.4 WUXGAGL	BROADWAY_PRO
AS8943G-728G1.28 TWn	Philippines	LX.PUH02 .250	AS8943G_BROADWAY_PRO1GBC FPssQ_3D4V3J	Ci7720QM	NLED18.4 WUXGAGL	BROADWAY_PRO
AS8943G-728G1.28 TWn	Singapore	LX.PUH02 .189	AS8943G_BROADWAY_PRO1GBC FPssQ_3D4V3J	Ci7720QM	NLED18.4 WUXGAGL	BROADWAY_PRO
AS8943G-728G1.28 TWn	Singapore	LX.PUG02 .008	AS8943G_BROADWAY_PRO1GBT CFPssQ_3D4V3J	Ci7720QM	NLED18.4 WUXGAGL	BROADWAY_PRO
AS8943G-728G1.28 TWn	Switzerland	LX.PUH02 .185	AS8943G_BROADWAY_PRO1GBC FPssQ_3D4V3J	Ci7720QM	NLED18.4 WUXGAGL	BROADWAY_PRO
AS8943G-728G1.28 TWn	Switzerland	LX.PUH02 .184	AS8943G_BROADWAY_PRO1GBC FPssQ_3D4V3J	Ci7720QM	NLED18.4 WUXGAGL	BROADWAY_PRO
AS8943G-728G1.28 TWn	Switzerland	LX.PUG02 .005	AS8943G_BROADWAY_PRO1GBT CFPssQ_3D4V3J	Ci7720QM	NLED18.4 WUXGAGL	BROADWAY_PRO
AS8943G-728G1.28 TWn	Thailand	LX.PUH02 .253	AS8943G_BROADWAY_PRO1GBC FPssQ_3D4V3J	Ci7720QM	NLED18.4 WUXGAGL	BROADWAY_PRO
AS8943G-728G1.28 TWn	Thailand	LX.PUH02 .252	AS8943G_BROADWAY_PRO1GBC FPssQ_3D4V3J	Ci7720QM	NLED18.4 WUXGAGL	BROADWAY_PRO
AS8943G-728G1TBi	Russia	LX.PUH02 .136	AS8943G_BROADWAY_PRO1GBC FPssQ_3D4V3J	Ci7720QM	NLED18.4 WUXGAGL	BROADWAY_PRO
AS8943G-728G1TBn	Algeria	LX.PUH02 .128	AS8943G_BROADWAY_PRO1GBC FPssQ_3D4V3J	Ci7720QM	NLED18.4 WUXGAGL	BROADWAY_PRO

Model	Country	Acer P/N	BOM Name	CPU	LCD	VGA Chip
AS8943G-728G1TBn	Austria	LX.PUH02.094	AS8943G_BROADWAY_PRO1GBCFPssQ_3D4V3J	Ci7720QM	NLED18.4WUXGAGL	BROADWAY_PRO
AS8943G-728G1TBn	Baltic	LX.PUH02.119	AS8943G_BROADWAY_PRO1GBCFPssQ_3D4V3J	Ci7720QM	NLED18.4WUXGAGL	BROADWAY_PRO
AS8943G-728G1TBn	Baltic	LX.PUH02.102	AS8943G_BROADWAY_PRO1GBCFPssQ_3D4V3J	Ci7720QM	NLED18.4WUXGAGL	BROADWAY_PRO
AS8943G-728G1TBn	Baltic	LX.PUH02.098	AS8943G_BROADWAY_PRO1GBCFPssQ_3D4V3J	Ci7720QM	NLED18.4WUXGAGL	BROADWAY_PRO
AS8943G-728G1TBn	Belgium	LX.PUH02.116	AS8943G_BROADWAY_PRO1GBCFPssQ_3D4V3J	Ci7720QM	NLED18.4WUXGAGL	BROADWAY_PRO
AS8943G-728G1TBn	Cyprus	LX.PUH02.101	AS8943G_BROADWAY_PRO1GBCFPssQ_3D4V3J	Ci7720QM	NLED18.4WUXGAGL	BROADWAY_PRO
AS8943G-728G1TBn	Czech	LX.PUH02.105	AS8943G_BROADWAY_PRO1GBCFPssQ_3D4V3J	Ci7720QM	NLED18.4WUXGAGL	BROADWAY_PRO
AS8943G-728G1TBn	Denmark	LX.PUH02.096	AS8943G_BROADWAY_PRO1GBCFPssQ_3D4V3J	Ci7720QM	NLED18.4WUXGAGL	BROADWAY_PRO
AS8943G-728G1TBn	Eastern Europe	LX.PUH02.112	AS8943G_BROADWAY_PRO1GBCFPssQ_3D4V3J	Ci7720QM	NLED18.4WUXGAGL	BROADWAY_PRO
AS8943G-728G1TBn	Eastern Europe	LX.PUH02.111	AS8943G_BROADWAY_PRO1GBCFPssQ_3D4V3J	Ci7720QM	NLED18.4WUXGAGL	BROADWAY_PRO
AS8943G-728G1TBn	Eastern Europe	LX.PUH02.110	AS8943G_BROADWAY_PRO1GBCFPssQ_3D4V3J	Ci7720QM	NLED18.4WUXGAGL	BROADWAY_PRO
AS8943G-728G1TBn	Eastern Europe	LX.PUH02.107	AS8943G_BROADWAY_PRO1GBCFPssQ_3D4V3J	Ci7720QM	NLED18.4WUXGAGL	BROADWAY_PRO
AS8943G-728G1TBn	Eastern Europe	LX.PUH02.093	AS8943G_BROADWAY_PRO1GBCFPssQ_3D4V3J	Ci7720QM	NLED18.4WUXGAGL	BROADWAY_PRO
AS8943G-728G1TBn	France	LX.PUH02.092	AS8943G_BROADWAY_PRO1GBCFPssQ_3D4V3J	Ci7720QM	NLED18.4WUXGAGL	BROADWAY_PRO
AS8943G-728G1TBn	Germany	LX.PUH02.120	AS8943G_BROADWAY_PRO1GBCFPssQ_3D4V3J	Ci7720QM	NLED18.4WUXGAGL	BROADWAY_PRO
AS8943G-728G1TBn	Greece	LX.PUH02.095	AS8943G_BROADWAY_PRO1GBCFPssQ_3D4V3J	Ci7720QM	NLED18.4WUXGAGL	BROADWAY_PRO
AS8943G-728G1TBn	Holland	LX.PUH02.117	AS8943G_BROADWAY_PRO1GBCFPssQ_3D4V3J	Ci7720QM	NLED18.4WUXGAGL	BROADWAY_PRO

Model	Country	Acer P/N	BOM Name	CPU	LCD	VGA Chip
AS8943G-728G1TBn	Hungary	LX.PUH02.104	AS8943G_BROADWAY_PRO1GBCFPssQ_3D4V3J	Ci7720QM	NLED18.4WUXGAGL	BROADWAY_PRO
AS8943G-728G1TBn	Israel	LX.PUH02.103	AS8943G_BROADWAY_PRO1GBCFPssQ_3D4V3J	Ci7720QM	NLED18.4WUXGAGL	BROADWAY_PRO
AS8943G-728G1TBn	Italy	LX.PUH02.109	AS8943G_BROADWAY_PRO1GBCFPssQ_3D4V3J	Ci7720QM	NLED18.4WUXGAGL	BROADWAY_PRO
AS8943G-728G1TBn	Latvia	LX.PUH02.114	AS8943G_BROADWAY_PRO1GBCFPssQ_3D4V3J	Ci7720QM	NLED18.4WUXGAGL	BROADWAY_PRO
AS8943G-728G1TBn	Latvia	LX.PUH02.113	AS8943G_BROADWAY_PRO1GBCFPssQ_3D4V3J	Ci7720QM	NLED18.4WUXGAGL	BROADWAY_PRO
AS8943G-728G1TBn	Luxembourg	LX.PUH02.118	AS8943G_BROADWAY_PRO1GBCFPssQ_3D4V3J	Ci7720QM	NLED18.4WUXGAGL	BROADWAY_PRO
AS8943G-728G1TBn	Middle East	LX.PUH02.135	AS8943G_BROADWAY_PRO1GBCFPssQ_3D4V3J	Ci7720QM	NLED18.4WUXGAGL	BROADWAY_PRO
AS8943G-728G1TBn	Middle East	LX.PUH02.134	AS8943G_BROADWAY_PRO1GBCFPssQ_3D4V3J	Ci7720QM	NLED18.4WUXGAGL	BROADWAY_PRO
AS8943G-728G1TBn	Middle East	LX.PUH02.131	AS8943G_BROADWAY_PRO1GBCFPssQ_3D4V3J	Ci7720QM	NLED18.4WUXGAGL	BROADWAY_PRO
AS8943G-728G1TBn	Middle East	LX.PUH02.130	AS8943G_BROADWAY_PRO1GBCFPssQ_3D4V3J	Ci7720QM	NLED18.4WUXGAGL	BROADWAY_PRO
AS8943G-728G1TBn	Middle East	LX.PUH02.129	AS8943G_BROADWAY_PRO1GBCFPssQ_3D4V3J	Ci7720QM	NLED18.4WUXGAGL	BROADWAY_PRO
AS8943G-728G1TBn	Middle East	LX.PUH02.126	AS8943G_BROADWAY_PRO1GBCFPssQ_3D4V3J	Ci7720QM	NLED18.4WUXGAGL	BROADWAY_PRO
AS8943G-728G1TBn	Middle East	LX.PUH02.125	AS8943G_BROADWAY_PRO1GBCFPssQ_3D4V3J	Ci7720QM	NLED18.4WUXGAGL	BROADWAY_PRO
AS8943G-728G1TBn	Middle East	LX.PUH02.124	AS8943G_BROADWAY_PRO1GBCFPssQ_3D4V3J	Ci7720QM	NLED18.4WUXGAGL	BROADWAY_PRO
AS8943G-728G1TBn	Middle East	LX.PUH02.123	AS8943G_BROADWAY_PRO1GBCFPssQ_3D4V3J	Ci7720QM	NLED18.4WUXGAGL	BROADWAY_PRO
AS8943G-728G1TBn	Poland	LX.PUH02.121	AS8943G_BROADWAY_PRO1GBCFPssQ_3D4V3J	Ci7720QM	NLED18.4WUXGAGL	BROADWAY_PRO
AS8943G-728G1TBn	Portugal	LX.PUH02.099	AS8943G_BROADWAY_PRO1GBCFPssQ_3D4V3J	Ci7720QM	NLED18.4WUXGAGL	BROADWAY_PRO

Model	Country	Acer P/N	BOM Name	CPU	LCD	VGA Chip
AS8943G-728G1TBn	Serbia/Macedonia	LX.PUH02.097	AS8943G_BROADWAY_PRO1GBCFPssQ_3D4V3J	Ci7720QM	NLED18.4WUXGAGL	BROADWAY_PRO
AS8943G-728G1TBn	South Africa	LX.PUH02.133	AS8943G_BROADWAY_PRO1GBCFPssQ_3D4V3J	Ci7720QM	NLED18.4WUXGAGL	BROADWAY_PRO
AS8943G-728G1TBn	South Africa	LX.PUH02.127	AS8943G_BROADWAY_PRO1GBCFPssQ_3D4V3J	Ci7720QM	NLED18.4WUXGAGL	BROADWAY_PRO
AS8943G-728G1TBn	South Africa	LX.PUH02.122	AS8943G_BROADWAY_PRO1GBCFPssQ_3D4V3J	Ci7720QM	NLED18.4WUXGAGL	BROADWAY_PRO
AS8943G-728G1TBn	Spain	LX.PUH02.108	AS8943G_BROADWAY_PRO1GBCFPssQ_3D4V3J	Ci7720QM	NLED18.4WUXGAGL	BROADWAY_PRO
AS8943G-728G1TBn	Spain	LX.PUG02.002	AS8943G_BROADWAY_PRO1GBT CFPssQ_3D4V3J	Ci7720QM	NLED18.4WUXGAGL	BROADWAY_PRO
AS8943G-728G1TBn	Switzerland	LX.PUH02.186	AS8943G_BROADWAY_PRO1GBCFPssQ_3D4V3J	Ci7720QM	NLED18.4WUXGAGL	BROADWAY_PRO
AS8943G-728G1TBn	Switzerland	LX.PUH02.115	AS8943G_BROADWAY_PRO1GBCFPssQ_3D4V3J	Ci7720QM	NLED18.4WUXGAGL	BROADWAY_PRO
AS8943G-728G1TBn	Turkey	LX.PUH02.132	AS8943G_BROADWAY_PRO1GBCFPssQ_3D4V3J	Ci7720QM	NLED18.4WUXGAGL	BROADWAY_PRO
AS8943G-728G1TBn	UK	LX.PUH02.106	AS8943G_BROADWAY_PRO1GBCFPssQ_3D4V3J	Ci7720QM	NLED18.4WUXGAGL	BROADWAY_PRO
AS8943G-728G1TBn	Ukraine	LX.PUH02.137	AS8943G_BROADWAY_PRO1GBCFPssQ_3D4V3J	Ci7720QM	NLED18.4WUXGAGL	BROADWAY_PRO
AS8943G-728G1TMn	GCTWN	S2.PUG02.001	AS8943G_BROADWAY_PRO1GBT CFPssQ_3D4V3J	Ci7720QM	NLED18.4WUXGAGL	BROADWAY_PRO
AS8943G-728G1TMn	GCTWN	S2.PUG02.001	AS8943G_BROADWAY_PRO1GBT CFPssQ_3D4V3J	Ci7720QM	NLED18.4WUXGAGL	BROADWAY_PRO
AS8943G-728G1TMn	WW	S2.PUH02.001	AS8943G_BROADWAY_PRO1GBCFPssQ_3D4V3J	Ci7720QM	NLED18.4WUXGAGL	BROADWAY_PRO
AS8943G-728G1TMn	WW	S2.PUH02.001	AS8943G_BROADWAY_PRO1GBCFPssQ_3D4V3J	Ci7720QM	NLED18.4WUXGAGL	BROADWAY_PRO
AS8943G-728G1TWi	Russia	LX.PUH02.187	AS8943G_BROADWAY_PRO1GBCFPssQ_3D4V3J	Ci7720QM	NLED18.4WUXGAGL	BROADWAY_PRO
AS8943G-728G1TWn	UK	LX.PUG02.013	AS8943G_BROADWAY_PRO1GBT CFPssQ_3D4V3J	Ci7720QM	NLED18.4WUXGAGL	BROADWAY_PRO

Model	Country	Acer P/N	BOM Name	CPU	LCD	VGA Chip
AS8943G-728G64Bi	Russia	LX.PUH02.090	AS8943G_BROADWAY_PRO1GBCFPssQ_3D4V3J	Ci7720QM	NLED18.4WUXGAGL	BROADWAY_PRO
AS8943G-728G64Bn	Algeria	LX.PUH02.082	AS8943G_BROADWAY_PRO1GBCFPssQ_3D4V3J	Ci7720QM	NLED18.4WUXGAGL	BROADWAY_PRO
AS8943G-728G64Bn	Austria	LX.PUH02.049	AS8943G_BROADWAY_PRO1GBCFPssQ_3D4V3J	Ci7720QM	NLED18.4WUXGAGL	BROADWAY_PRO
AS8943G-728G64Bn	Baltic	LX.PUH02.073	AS8943G_BROADWAY_PRO1GBCFPssQ_3D4V3J	Ci7720QM	NLED18.4WUXGAGL	BROADWAY_PRO
AS8943G-728G64Bn	Baltic	LX.PUH02.060	AS8943G_BROADWAY_PRO1GBCFPssQ_3D4V3J	Ci7720QM	NLED18.4WUXGAGL	BROADWAY_PRO
AS8943G-728G64Bn	Baltic	LX.PUH02.057	AS8943G_BROADWAY_PRO1GBCFPssQ_3D4V3J	Ci7720QM	NLED18.4WUXGAGL	BROADWAY_PRO
AS8943G-728G64Bn	Belgium	LX.PUH02.070	AS8943G_BROADWAY_PRO1GBCFPssQ_3D4V3J	Ci7720QM	NLED18.4WUXGAGL	BROADWAY_PRO
AS8943G-728G64Bn	Cyprus	LX.PUH02.059	AS8943G_BROADWAY_PRO1GBCFPssQ_3D4V3J	Ci7720QM	NLED18.4WUXGAGL	BROADWAY_PRO
AS8943G-728G64Bn	Czech	LX.PUH02.063	AS8943G_BROADWAY_PRO1GBCFPssQ_3D4V3J	Ci7720QM	NLED18.4WUXGAGL	BROADWAY_PRO
AS8943G-728G64Bn	Denmark	LX.PUH02.055	AS8943G_BROADWAY_PRO1GBCFPssQ_3D4V3J	Ci7720QM	NLED18.4WUXGAGL	BROADWAY_PRO
AS8943G-728G64Bn	Eastern Europe	LX.PUH02.066	AS8943G_BROADWAY_PRO1GBCFPssQ_3D4V3J	Ci7720QM	NLED18.4WUXGAGL	BROADWAY_PRO
AS8943G-728G64Bn	Eastern Europe	LX.PUH02.065	AS8943G_BROADWAY_PRO1GBCFPssQ_3D4V3J	Ci7720QM	NLED18.4WUXGAGL	BROADWAY_PRO
AS8943G-728G64Bn	Eastern Europe	LX.PUH02.054	AS8943G_BROADWAY_PRO1GBCFPssQ_3D4V3J	Ci7720QM	NLED18.4WUXGAGL	BROADWAY_PRO
AS8943G-728G64Bn	Eastern Europe	LX.PUH02.053	AS8943G_BROADWAY_PRO1GBCFPssQ_3D4V3J	Ci7720QM	NLED18.4WUXGAGL	BROADWAY_PRO
AS8943G-728G64Bn	Eastern Europe	LX.PUH02.048	AS8943G_BROADWAY_PRO1GBCFPssQ_3D4V3J	Ci7720QM	NLED18.4WUXGAGL	BROADWAY_PRO
AS8943G-728G64Bn	France	LX.PUH02.047	AS8943G_BROADWAY_PRO1GBCFPssQ_3D4V3J	Ci7720QM	NLED18.4WUXGAGL	BROADWAY_PRO
AS8943G-728G64Bn	Germany	LX.PUH02.074	AS8943G_BROADWAY_PRO1GBCFPssQ_3D4V3J	Ci7720QM	NLED18.4WUXGAGL	BROADWAY_PRO

Model	Country	Acer P/N	BOM Name	CPU	LCD	VGA Chip
AS8943G-728G64Bn	Greece	LX.PUH02.050	AS8943G_BROADWAY_PRO1GBCFPssQ_3D4V3J	Ci7720QM	NLED18.4WUXGAGL	BROADWAY_PRO
AS8943G-728G64Bn	Holland	LX.PUH02.071	AS8943G_BROADWAY_PRO1GBCFPssQ_3D4V3J	Ci7720QM	NLED18.4WUXGAGL	BROADWAY_PRO
AS8943G-728G64Bn	Hungary	LX.PUH02.062	AS8943G_BROADWAY_PRO1GBCFPssQ_3D4V3J	Ci7720QM	NLED18.4WUXGAGL	BROADWAY_PRO
AS8943G-728G64Bn	Israel	LX.PUH02.061	AS8943G_BROADWAY_PRO1GBCFPssQ_3D4V3J	Ci7720QM	NLED18.4WUXGAGL	BROADWAY_PRO
AS8943G-728G64Bn	Italy	LX.PUH02.052	AS8943G_BROADWAY_PRO1GBCFPssQ_3D4V3J	Ci7720QM	NLED18.4WUXGAGL	BROADWAY_PRO
AS8943G-728G64Bn	Latvia	LX.PUH02.068	AS8943G_BROADWAY_PRO1GBCFPssQ_3D4V3J	Ci7720QM	NLED18.4WUXGAGL	BROADWAY_PRO
AS8943G-728G64Bn	Latvia	LX.PUH02.067	AS8943G_BROADWAY_PRO1GBCFPssQ_3D4V3J	Ci7720QM	NLED18.4WUXGAGL	BROADWAY_PRO
AS8943G-728G64Bn	Luxembourg	LX.PUH02.072	AS8943G_BROADWAY_PRO1GBCFPssQ_3D4V3J	Ci7720QM	NLED18.4WUXGAGL	BROADWAY_PRO
AS8943G-728G64Bn	Middle East	LX.PUH02.089	AS8943G_BROADWAY_PRO1GBCFPssQ_3D4V3J	Ci7720QM	NLED18.4WUXGAGL	BROADWAY_PRO
AS8943G-728G64Bn	Middle East	LX.PUH02.088	AS8943G_BROADWAY_PRO1GBCFPssQ_3D4V3J	Ci7720QM	NLED18.4WUXGAGL	BROADWAY_PRO
AS8943G-728G64Bn	Middle East	LX.PUH02.085	AS8943G_BROADWAY_PRO1GBCFPssQ_3D4V3J	Ci7720QM	NLED18.4WUXGAGL	BROADWAY_PRO
AS8943G-728G64Bn	Middle East	LX.PUH02.084	AS8943G_BROADWAY_PRO1GBCFPssQ_3D4V3J	Ci7720QM	NLED18.4WUXGAGL	BROADWAY_PRO
AS8943G-728G64Bn	Middle East	LX.PUH02.083	AS8943G_BROADWAY_PRO1GBCFPssQ_3D4V3J	Ci7720QM	NLED18.4WUXGAGL	BROADWAY_PRO
AS8943G-728G64Bn	Middle East	LX.PUH02.080	AS8943G_BROADWAY_PRO1GBCFPssQ_3D4V3J	Ci7720QM	NLED18.4WUXGAGL	BROADWAY_PRO
AS8943G-728G64Bn	Middle East	LX.PUH02.079	AS8943G_BROADWAY_PRO1GBCFPssQ_3D4V3J	Ci7720QM	NLED18.4WUXGAGL	BROADWAY_PRO
AS8943G-728G64Bn	Middle East	LX.PUH02.078	AS8943G_BROADWAY_PRO1GBCFPssQ_3D4V3J	Ci7720QM	NLED18.4WUXGAGL	BROADWAY_PRO
AS8943G-728G64Bn	Middle East	LX.PUH02.077	AS8943G_BROADWAY_PRO1GBCFPssQ_3D4V3J	Ci7720QM	NLED18.4WUXGAGL	BROADWAY_PRO

Model	Country	Acer P/N	BOM Name	CPU	LCD	VGA Chip
AS8943G-728G64Bn	Poland	LX.PUH02.075	AS8943G_BROADWAY_PRO1GBCFPssQ_3D4V3J	Ci7720QM	NLED18.4WUXGAGL	BROADWAY_PRO
AS8943G-728G64Bn	Portugal	LX.PUH02.058	AS8943G_BROADWAY_PRO1GBCFPssQ_3D4V3J	Ci7720QM	NLED18.4WUXGAGL	BROADWAY_PRO
AS8943G-728G64Bn	Serbia/Macedonia	LX.PUH02.056	AS8943G_BROADWAY_PRO1GBCFPssQ_3D4V3J	Ci7720QM	NLED18.4WUXGAGL	BROADWAY_PRO
AS8943G-728G64Bn	South Africa	LX.PUH02.087	AS8943G_BROADWAY_PRO1GBCFPssQ_3D4V3J	Ci7720QM	NLED18.4WUXGAGL	BROADWAY_PRO
AS8943G-728G64Bn	South Africa	LX.PUH02.081	AS8943G_BROADWAY_PRO1GBCFPssQ_3D4V3J	Ci7720QM	NLED18.4WUXGAGL	BROADWAY_PRO
AS8943G-728G64Bn	South Africa	LX.PUH02.076	AS8943G_BROADWAY_PRO1GBCFPssQ_3D4V3J	Ci7720QM	NLED18.4WUXGAGL	BROADWAY_PRO
AS8943G-728G64Bn	Spain	LX.PUH02.051	AS8943G_BROADWAY_PRO1GBCFPssQ_3D4V3J	Ci7720QM	NLED18.4WUXGAGL	BROADWAY_PRO
AS8943G-728G64Bn	Switzerland	LX.PUH02.069	AS8943G_BROADWAY_PRO1GBCFPssQ_3D4V3J	Ci7720QM	NLED18.4WUXGAGL	BROADWAY_PRO
AS8943G-728G64Bn	Turkey	LX.PUH02.086	AS8943G_BROADWAY_PRO1GBCFPssQ_3D4V3J	Ci7720QM	NLED18.4WUXGAGL	BROADWAY_PRO
AS8943G-728G64Bn	UK	LX.PUH02.064	AS8943G_BROADWAY_PRO1GBCFPssQ_3D4V3J	Ci7720QM	NLED18.4WUXGAGL	BROADWAY_PRO
AS8943G-728G64Bn	Ukraine	LX.PUH02.091	AS8943G_BROADWAY_PRO1GBCFPssQ_3D4V3J	Ci7720QM	NLED18.4WUXGAGL	BROADWAY_PRO
AS8943G-82121.28TBn	WW	S2.PWC02.007	AS8943G_MADISON_PRO1GBCFPssQ_3D4V3J	Ci7820QM	NLED18.4WUXGAGL	MADISON_PRO
AS8943G-82121.28TBn	WW	S2.PWC02.007	AS8943G_MADISON_PRO1GBCFPssQ_3D4V3J	Ci7820QM	NLED18.4WUXGAGL	MADISON_PRO
AS8943G-82161.28TWn	UK	LX.PWC02.075	AS8943G_MADISON_PRO1GBCFPssQ_3D4V3J	Ci7820QM	NLED18.4WUXGAGL	MADISON_PRO
AS8943G-82161.28TWn	WW	S2.PU102.001	AS8943G_BROADWAY_PRO1GBCFPss_3V3J	Ci7820QM	NLED18.4WUXGAGL	BROADWAY_PRO
AS8943G-82161.28TWn	WW	S2.PU102.001	AS8943G_BROADWAY_PRO1GBCFPss_3V3J	Ci7820QM	NLED18.4WUXGAGL	BROADWAY_PRO
AS8943G-828G1.28TMn	Philippines	LX.PUH02.243	AS8943G_BROADWAY_PRO1GBCFPssQ_3D4V3J	Ci7820QM	NLED18.4WUXGAGL	BROADWAY_PRO

Model	Country	Acer P/N	VRAM 1	Memory 1	Memory 2	Memory 3
AS8943G-332G57Mn	WW	S2.PTL02.001	1G-DDR3 (64*16*8)	SO1GBIII10	SO1GBIII10	N
AS8943G-332G57Mn	WW	S2.PTL02.001	1G-DDR3 (64*16*8)	SO1GBIII10	SO1GBIII10	N
AS8943G-333G32Mn	Turkey	LX.PUJ02.058	1G-DDR3 (64*16*8)	SO2GBIII10	SO1GBIII10	N
AS8943G-334G50Mi	Russia	LX.PUJ02.006	1G-DDR3 (64*16*8)	SO2GBIII10	SO2GBIII10	N
AS8943G-334G50Mn	France	LX.PUJ02.004	1G-DDR3 (64*16*8)	SO2GBIII10	SO2GBIII10	N
AS8943G-334G64Mn	Belgium	LX.PU202.005	1G-DDR3 (64*16*8)	SO2GBIII10	SO2GBIII10	N
AS8943G-334G64Mn	Holland	LX.PU202.004	1G-DDR3 (64*16*8)	SO2GBIII10	SO2GBIII10	N
AS8943G-334G64Mn	Luxembourg	LX.PU202.003	1G-DDR3 (64*16*8)	SO2GBIII10	SO2GBIII10	N
AS8943G-354G50Mn	France	LX.PUJ02.059	1G-DDR3 (64*16*8)	SO2GBIII10	SO2GBIII10	N
AS8943G-432G82Mn	WW	S2.PTL02.003	1G-DDR3 (64*16*8)	SO1GBIII10	SO1GBIII10	N
AS8943G-432G82Mn	WW	S2.PTL02.003	1G-DDR3 (64*16*8)	SO1GBIII10	SO1GBIII10	N
AS8943G-434G1TBi	Russia	LX.PUJ02.051	1G-DDR3 (64*16*8)	SO2GBIII10	SO2GBIII10	N
AS8943G-434G1TBn	Algeria	LX.PUJ02.027	1G-DDR3 (64*16*8)	SO2GBIII10	SO2GBIII10	N
AS8943G-434G1TBn	Austria	LX.PUJ02.009	1G-DDR3 (64*16*8)	SO2GBIII10	SO2GBIII10	N
AS8943G-434G1TBn	Baltic	LX.PUJ02.047	1G-DDR3 (64*16*8)	SO2GBIII10	SO2GBIII10	N
AS8943G-434G1TBn	Baltic	LX.PUJ02.020	1G-DDR3 (64*16*8)	SO2GBIII10	SO2GBIII10	N
AS8943G-434G1TBn	Baltic	LX.PUJ02.017	1G-DDR3 (64*16*8)	SO2GBIII10	SO2GBIII10	N
AS8943G-434G1TBn	Belgium	LX.PUJ02.045	1G-DDR3 (64*16*8)	SO2GBIII10	SO2GBIII10	N
AS8943G-434G1TBn	Cyprus	LX.PUJ02.018	1G-DDR3 (64*16*8)	SO2GBIII10	SO2GBIII10	N
AS8943G-434G1TBn	Czech	LX.PUJ02.037	1G-DDR3 (64*16*8)	SO2GBIII10	SO2GBIII10	N
AS8943G-434G1TBn	Denmark	LX.PUJ02.013	1G-DDR3 (64*16*8)	SO2GBIII10	SO2GBIII10	N
AS8943G-434G1TBn	Eastern Europe	LX.PUJ02.039	1G-DDR3 (64*16*8)	SO2GBIII10	SO2GBIII10	N
AS8943G-434G1TBn	Eastern Europe	LX.PUJ02.038	1G-DDR3 (64*16*8)	SO2GBIII10	SO2GBIII10	N
AS8943G-434G1TBn	Eastern Europe	LX.PUJ02.012	1G-DDR3 (64*16*8)	SO2GBIII10	SO2GBIII10	N

Model	Country	Acer P/N	VRAM 1	Memory 1	Memory 2	Memory 3
AS8943G-434G1TBn	Eastern Europe	LX.PUJ02.011	1G-DDR3 (64*16*8)	SO2GBIII10	SO2GBIII10	N
AS8943G-434G1TBn	Eastern Europe	LX.PUJ02.007	1G-DDR3 (64*16*8)	SO2GBIII10	SO2GBIII10	N
AS8943G-434G1TBn	France	LX.PUJ02.008	1G-DDR3 (64*16*8)	SO2GBIII10	SO2GBIII10	N
AS8943G-434G1TBn	Germany	LX.PUJ02.049	1G-DDR3 (64*16*8)	SO2GBIII10	SO2GBIII10	N
AS8943G-434G1TBn	Greece	LX.PUJ02.010	1G-DDR3 (64*16*8)	SO2GBIII10	SO2GBIII10	N
AS8943G-434G1TBn	Holland	LX.PUJ02.046	1G-DDR3 (64*16*8)	SO2GBIII10	SO2GBIII10	N
AS8943G-434G1TBn	Hungary	LX.PUJ02.036	1G-DDR3 (64*16*8)	SO2GBIII10	SO2GBIII10	N
AS8943G-434G1TBn	Israel	LX.PUJ02.035	1G-DDR3 (64*16*8)	SO2GBIII10	SO2GBIII10	N
AS8943G-434G1TBn	Italy	LX.PUJ02.015	1G-DDR3 (64*16*8)	SO2GBIII10	SO2GBIII10	N
AS8943G-434G1TBn	Latvia	LX.PUJ02.042	1G-DDR3 (64*16*8)	SO2GBIII10	SO2GBIII10	N
AS8943G-434G1TBn	Latvia	LX.PUJ02.041	1G-DDR3 (64*16*8)	SO2GBIII10	SO2GBIII10	N
AS8943G-434G1TBn	Luxembourg	LX.PUJ02.043	1G-DDR3 (64*16*8)	SO2GBIII10	SO2GBIII10	N
AS8943G-434G1TBn	Middle East	LX.PUJ02.050	1G-DDR3 (64*16*8)	SO2GBIII10	SO2GBIII10	N
AS8943G-434G1TBn	Middle East	LX.PUJ02.034	1G-DDR3 (64*16*8)	SO2GBIII10	SO2GBIII10	N
AS8943G-434G1TBn	Middle East	LX.PUJ02.031	1G-DDR3 (64*16*8)	SO2GBIII10	SO2GBIII10	N
AS8943G-434G1TBn	Middle East	LX.PUJ02.030	1G-DDR3 (64*16*8)	SO2GBIII10	SO2GBIII10	N
AS8943G-434G1TBn	Middle East	LX.PUJ02.028	1G-DDR3 (64*16*8)	SO2GBIII10	SO2GBIII10	N
AS8943G-434G1TBn	Middle East	LX.PUJ02.025	1G-DDR3 (64*16*8)	SO2GBIII10	SO2GBIII10	N
AS8943G-434G1TBn	Middle East	LX.PUJ02.024	1G-DDR3 (64*16*8)	SO2GBIII10	SO2GBIII10	N
AS8943G-434G1TBn	Middle East	LX.PUJ02.023	1G-DDR3 (64*16*8)	SO2GBIII10	SO2GBIII10	N
AS8943G-434G1TBn	Middle East	LX.PUJ02.022	1G-DDR3 (64*16*8)	SO2GBIII10	SO2GBIII10	N
AS8943G-434G1TBn	Poland	LX.PUJ02.048	1G-DDR3 (64*16*8)	SO2GBIII10	SO2GBIII10	N
AS8943G-434G1TBn	Portugal	LX.PUJ02.019	1G-DDR3 (64*16*8)	SO2GBIII10	SO2GBIII10	N
AS8943G-434G1TBn	Serbia/ Macedonia	LX.PUJ02.016	1G-DDR3 (64*16*8)	SO2GBIII10	SO2GBIII10	N

Model	Country	Acer P/N	VRAM 1	Memory 1	Memory 2	Memory 3
AS8943G-434G1TBn	South Africa	LX.PUJ02.033	1G-DDR3 (64*16*8)	SO2GBIII10	SO2GBIII10	N
AS8943G-434G1TBn	South Africa	LX.PUJ02.029	1G-DDR3 (64*16*8)	SO2GBIII10	SO2GBIII10	N
AS8943G-434G1TBn	South Africa	LX.PUJ02.026	1G-DDR3 (64*16*8)	SO2GBIII10	SO2GBIII10	N
AS8943G-434G1TBn	South Africa	LX.PUJ02.021	1G-DDR3 (64*16*8)	SO2GBIII10	SO2GBIII10	N
AS8943G-434G1TBn	Spain	LX.PUJ02.014	1G-DDR3 (64*16*8)	SO2GBIII10	SO2GBIII10	N
AS8943G-434G1TBn	Switzerland	LX.PUJ02.044	1G-DDR3 (64*16*8)	SO2GBIII10	SO2GBIII10	N
AS8943G-434G1TBn	Turkey	LX.PUJ02.032	1G-DDR3 (64*16*8)	SO2GBIII10	SO2GBIII10	N
AS8943G-434G1TBn	UK	LX.PUJ02.040	1G-DDR3 (64*16*8)	SO2GBIII10	SO2GBIII10	N
AS8943G-434G1TBn	Ukraine	LX.PUJ02.052	1G-DDR3 (64*16*8)	SO2GBIII10	SO2GBIII10	N
AS8943G-434G1TMn	Belgium	LX.PUJ02.055	1G-DDR3 (64*16*8)	SO2GBIII10	SO2GBIII10	N
AS8943G-434G1TMn	France	LX.PUJ02.003	1G-DDR3 (64*16*8)	SO2GBIII10	SO2GBIII10	N
AS8943G-434G1TMn	Holland	LX.PUJ02.054	1G-DDR3 (64*16*8)	SO2GBIII10	SO2GBIII10	N
AS8943G-434G1TMn	Luxembourg	LX.PUJ02.053	1G-DDR3 (64*16*8)	SO2GBIII10	SO2GBIII10	N
AS8943G-434G32Mn	Austria	LX.PU202.006	1G-DDR3 (64*16*8)	SO2GBIII10	SO2GBIII10	N
AS8943G-434G32Mn	Germany	LX.PU202.002	1G-DDR3 (64*16*8)	SO2GBIII10	SO2GBIII10	N
AS8943G-434G50Bn	UK	LX.PU202.007	1G-DDR3 (64*16*8)	SO2GBIII10	SO2GBIII10	N
AS8943G-434G50Mn	Denmark	LX.PU102.092	1G-DDR3 (64*16*8)	SO2GBIII10	SO2GBIII10	N
AS8943G-434G50Mn	Spain	LX.PUJ02.001	1G-DDR3 (64*16*8)	SO2GBIII10	SO2GBIII10	N
AS8943G-434G50Mn	Turkey	LX.PUJ02.056	1G-DDR3 (64*16*8)	SO2GBIII10	SO2GBIII10	N
AS8943G-434G64Bi	Russia	LX.PU102.099	1G-DDR3 (64*16*8)	SO2GBIII10	SO2GBIII10	N
AS8943G-434G64Bn	Czech	LX.PU102.103	1G-DDR3 (64*16*8)	SO2GBIII10	SO2GBIII10	N
AS8943G-434G64Mi	Russia	LX.PUJ02.060	1G-DDR3 (64*16*8)	SO2GBIII10	SO2GBIII10	N
AS8943G-434G64Mi	Russia	LX.PU102.044	1G-DDR3 (64*16*8)	SO2GBIII10	SO2GBIII10	N
AS8943G-434G64Mn	Algeria	LX.PU102.036	1G-DDR3 (64*16*8)	SO2GBIII10	SO2GBIII10	N

Model	Country	Acer P/N	VRAM 1	Memory 1	Memory 2	Memory 3
AS8943G-434G64Mn	Austria	LX.PU102.003	1G-DDR3 (64*16*8)	SO2GBIII10	SO2GBIII10	N
AS8943G-434G64Mn	Baltic	LX.PU102.022	1G-DDR3 (64*16*8)	SO2GBIII10	SO2GBIII10	N
AS8943G-434G64Mn	Baltic	LX.PU102.014	1G-DDR3 (64*16*8)	SO2GBIII10	SO2GBIII10	N
AS8943G-434G64Mn	Baltic	LX.PU102.011	1G-DDR3 (64*16*8)	SO2GBIII10	SO2GBIII10	N
AS8943G-434G64Mn	Belgium	LX.PU102.033	1G-DDR3 (64*16*8)	SO2GBIII10	SO2GBIII10	N
AS8943G-434G64Mn	Cyprus	LX.PU102.013	1G-DDR3 (64*16*8)	SO2GBIII10	SO2GBIII10	N
AS8943G-434G64Mn	Czech	LX.PU102.017	1G-DDR3 (64*16*8)	SO2GBIII10	SO2GBIII10	N
AS8943G-434G64Mn	Denmark	LX.PU102.009	1G-DDR3 (64*16*8)	SO2GBIII10	SO2GBIII10	N
AS8943G-434G64Mn	Eastern Europe	LX.PU102.020	1G-DDR3 (64*16*8)	SO2GBIII10	SO2GBIII10	N
AS8943G-434G64Mn	Eastern Europe	LX.PU102.019	1G-DDR3 (64*16*8)	SO2GBIII10	SO2GBIII10	N
AS8943G-434G64Mn	Eastern Europe	LX.PU102.008	1G-DDR3 (64*16*8)	SO2GBIII10	SO2GBIII10	N
AS8943G-434G64Mn	Eastern Europe	LX.PU102.007	1G-DDR3 (64*16*8)	SO2GBIII10	SO2GBIII10	N
AS8943G-434G64Mn	Eastern Europe	LX.PU102.002	1G-DDR3 (64*16*8)	SO2GBIII10	SO2GBIII10	N
AS8943G-434G64Mn	France	LX.PU102.001	1G-DDR3 (64*16*8)	SO2GBIII10	SO2GBIII10	N
AS8943G-434G64Mn	Germany	LX.PU102.023	1G-DDR3 (64*16*8)	SO2GBIII10	SO2GBIII10	N
AS8943G-434G64Mn	Greece	LX.PU102.004	1G-DDR3 (64*16*8)	SO2GBIII10	SO2GBIII10	N
AS8943G-434G64Mn	Holland	LX.PU102.034	1G-DDR3 (64*16*8)	SO2GBIII10	SO2GBIII10	N
AS8943G-434G64Mn	Hungary	LX.PU102.016	1G-DDR3 (64*16*8)	SO2GBIII10	SO2GBIII10	N
AS8943G-434G64Mn	Israel	LX.PU102.015	1G-DDR3 (64*16*8)	SO2GBIII10	SO2GBIII10	N
AS8943G-434G64Mn	Italy	LX.PU102.006	1G-DDR3 (64*16*8)	SO2GBIII10	SO2GBIII10	N
AS8943G-434G64Mn	Latvia	LX.PU102.031	1G-DDR3 (64*16*8)	SO2GBIII10	SO2GBIII10	N
AS8943G-434G64Mn	Latvia	LX.PU102.021	1G-DDR3 (64*16*8)	SO2GBIII10	SO2GBIII10	N
AS8943G-434G64Mn	Luxembourg	LX.PU102.035	1G-DDR3 (64*16*8)	SO2GBIII10	SO2GBIII10	N
AS8943G-434G64Mn	Middle East	LX.PU102.043	1G-DDR3 (64*16*8)	SO2GBIII10	SO2GBIII10	N

Model	Country	Acer P/N	VRAM 1	Memory 1	Memory 2	Memory 3
AS8943G-434G64Mn	Middle East	LX.PU102.042	1G-DDR3 (64*16*8)	SO2GBIII10	SO2GBIII10	N
AS8943G-434G64Mn	Middle East	LX.PU102.039	1G-DDR3 (64*16*8)	SO2GBIII10	SO2GBIII10	N
AS8943G-434G64Mn	Middle East	LX.PU102.038	1G-DDR3 (64*16*8)	SO2GBIII10	SO2GBIII10	N
AS8943G-434G64Mn	Middle East	LX.PU102.037	1G-DDR3 (64*16*8)	SO2GBIII10	SO2GBIII10	N
AS8943G-434G64Mn	Middle East	LX.PU102.029	1G-DDR3 (64*16*8)	SO2GBIII10	SO2GBIII10	N
AS8943G-434G64Mn	Middle East	LX.PU102.028	1G-DDR3 (64*16*8)	SO2GBIII10	SO2GBIII10	N
AS8943G-434G64Mn	Middle East	LX.PU102.027	1G-DDR3 (64*16*8)	SO2GBIII10	SO2GBIII10	N
AS8943G-434G64Mn	Middle East	LX.PU102.026	1G-DDR3 (64*16*8)	SO2GBIII10	SO2GBIII10	N
AS8943G-434G64Mn	Poland	LX.PU102.024	1G-DDR3 (64*16*8)	SO2GBIII10	SO2GBIII10	N
AS8943G-434G64Mn	Portugal	LX.PU102.012	1G-DDR3 (64*16*8)	SO2GBIII10	SO2GBIII10	N
AS8943G-434G64Mn	Serbia/ Macedonia	LX.PU102.010	1G-DDR3 (64*16*8)	SO2GBIII10	SO2GBIII10	N
AS8943G-434G64Mn	South Africa	LX.PU102.041	1G-DDR3 (64*16*8)	SO2GBIII10	SO2GBIII10	N
AS8943G-434G64Mn	South Africa	LX.PU102.030	1G-DDR3 (64*16*8)	SO2GBIII10	SO2GBIII10	N
AS8943G-434G64Mn	South Africa	LX.PU102.025	1G-DDR3 (64*16*8)	SO2GBIII10	SO2GBIII10	N
AS8943G-434G64Mn	Spain	LX.PUJ02.002	1G-DDR3 (64*16*8)	SO2GBIII10	SO2GBIII10	N
AS8943G-434G64Mn	Spain	LX.PU102.005	1G-DDR3 (64*16*8)	SO2GBIII10	SO2GBIII10	N
AS8943G-434G64Mn	Switzerland	LX.PU102.032	1G-DDR3 (64*16*8)	SO2GBIII10	SO2GBIII10	N
AS8943G-434G64Mn	Turkey	LX.PU102.097	1G-DDR3 (64*16*8)	SO2GBIII10	SO2GBIII10	N
AS8943G-434G64Mn	Turkey	LX.PU102.040	1G-DDR3 (64*16*8)	SO2GBIII10	SO2GBIII10	N
AS8943G-434G64Mn	UK	LX.PU102.018	1G-DDR3 (64*16*8)	SO2GBIII10	SO2GBIII10	N
AS8943G-434G64Mn	Ukraine	LX.PU102.045	1G-DDR3 (64*16*8)	SO2GBIII10	SO2GBIII10	N
AS8943G-436G1TBi	Russia	LX.PU102.089	1G-DDR3 (64*16*8)	SO4GBIII10	SO2GBIII10	N
AS8943G-436G1TBn	Algeria	LX.PU102.081	1G-DDR3 (64*16*8)	SO4GBIII10	SO2GBIII10	N
AS8943G-436G1TBn	Austria	LX.PU102.048	1G-DDR3 (64*16*8)	SO4GBIII10	SO2GBIII10	N

Model	Country	Acer P/N	VRAM 1	Memory 1	Memory 2	Memory 3
AS8943G-436G1TBn	Baltic	LX.PU102.072	1G-DDR3 (64*16*8)	SO4GBIII10	SO2GBIII10	N
AS8943G-436G1TBn	Baltic	LX.PU102.059	1G-DDR3 (64*16*8)	SO4GBIII10	SO2GBIII10	N
AS8943G-436G1TBn	Baltic	LX.PU102.056	1G-DDR3 (64*16*8)	SO4GBIII10	SO2GBIII10	N
AS8943G-436G1TBn	Belgium	LX.PU102.069	1G-DDR3 (64*16*8)	SO4GBIII10	SO2GBIII10	N
AS8943G-436G1TBn	Cyprus	LX.PU102.058	1G-DDR3 (64*16*8)	SO4GBIII10	SO2GBIII10	N
AS8943G-436G1TBn	Czech	LX.PU102.062	1G-DDR3 (64*16*8)	SO4GBIII10	SO2GBIII10	N
AS8943G-436G1TBn	Denmark	LX.PU102.054	1G-DDR3 (64*16*8)	SO4GBIII10	SO2GBIII10	N
AS8943G-436G1TBn	Eastern Europe	LX.PU102.065	1G-DDR3 (64*16*8)	SO4GBIII10	SO2GBIII10	N
AS8943G-436G1TBn	Eastern Europe	LX.PU102.064	1G-DDR3 (64*16*8)	SO4GBIII10	SO2GBIII10	N
AS8943G-436G1TBn	Eastern Europe	LX.PU102.053	1G-DDR3 (64*16*8)	SO4GBIII10	SO2GBIII10	N
AS8943G-436G1TBn	Eastern Europe	LX.PU102.052	1G-DDR3 (64*16*8)	SO4GBIII10	SO2GBIII10	N
AS8943G-436G1TBn	Eastern Europe	LX.PU102.047	1G-DDR3 (64*16*8)	SO4GBIII10	SO2GBIII10	N
AS8943G-436G1TBn	France	LX.PU102.046	1G-DDR3 (64*16*8)	SO4GBIII10	SO2GBIII10	N
AS8943G-436G1TBn	Germany	LX.PU102.073	1G-DDR3 (64*16*8)	SO4GBIII10	SO2GBIII10	N
AS8943G-436G1TBn	Greece	LX.PU102.049	1G-DDR3 (64*16*8)	SO4GBIII10	SO2GBIII10	N
AS8943G-436G1TBn	Holland	LX.PU102.070	1G-DDR3 (64*16*8)	SO4GBIII10	SO2GBIII10	N
AS8943G-436G1TBn	Hungary	LX.PU102.061	1G-DDR3 (64*16*8)	SO4GBIII10	SO2GBIII10	N
AS8943G-436G1TBn	Israel	LX.PU102.060	1G-DDR3 (64*16*8)	SO4GBIII10	SO2GBIII10	N
AS8943G-436G1TBn	Italy	LX.PU102.051	1G-DDR3 (64*16*8)	SO4GBIII10	SO2GBIII10	N
AS8943G-436G1TBn	Latvia	LX.PU102.067	1G-DDR3 (64*16*8)	SO4GBIII10	SO2GBIII10	N
AS8943G-436G1TBn	Latvia	LX.PU102.066	1G-DDR3 (64*16*8)	SO4GBIII10	SO2GBIII10	N
AS8943G-436G1TBn	Luxembourg	LX.PU102.071	1G-DDR3 (64*16*8)	SO4GBIII10	SO2GBIII10	N
AS8943G-436G1TBn	Middle East	LX.PU102.088	1G-DDR3 (64*16*8)	SO4GBIII10	SO2GBIII10	N
AS8943G-436G1TBn	Middle East	LX.PU102.087	1G-DDR3 (64*16*8)	SO4GBIII10	SO2GBIII10	N

Model	Country	Acer P/N	VRAM 1	Memory 1	Memory 2	Memory 3
AS8943G-436G1TBn	Middle East	LX.PU102.084	1G-DDR3 (64*16*8)	SO4GBIII10	SO2GBIII10	N
AS8943G-436G1TBn	Middle East	LX.PU102.083	1G-DDR3 (64*16*8)	SO4GBIII10	SO2GBIII10	N
AS8943G-436G1TBn	Middle East	LX.PU102.082	1G-DDR3 (64*16*8)	SO4GBIII10	SO2GBIII10	N
AS8943G-436G1TBn	Middle East	LX.PU102.079	1G-DDR3 (64*16*8)	SO4GBIII10	SO2GBIII10	N
AS8943G-436G1TBn	Middle East	LX.PU102.078	1G-DDR3 (64*16*8)	SO4GBIII10	SO2GBIII10	N
AS8943G-436G1TBn	Middle East	LX.PU102.077	1G-DDR3 (64*16*8)	SO4GBIII10	SO2GBIII10	N
AS8943G-436G1TBn	Middle East	LX.PU102.076	1G-DDR3 (64*16*8)	SO4GBIII10	SO2GBIII10	N
AS8943G-436G1TBn	Poland	LX.PU102.074	1G-DDR3 (64*16*8)	SO4GBIII10	SO2GBIII10	N
AS8943G-436G1TBn	Portugal	LX.PU102.057	1G-DDR3 (64*16*8)	SO4GBIII10	SO2GBIII10	N
AS8943G-436G1TBn	Serbia/ Macedonia	LX.PU102.055	1G-DDR3 (64*16*8)	SO4GBIII10	SO2GBIII10	N
AS8943G-436G1TBn	South Africa	LX.PU102.086	1G-DDR3 (64*16*8)	SO4GBIII10	SO2GBIII10	N
AS8943G-436G1TBn	South Africa	LX.PU102.080	1G-DDR3 (64*16*8)	SO4GBIII10	SO2GBIII10	N
AS8943G-436G1TBn	South Africa	LX.PU102.075	1G-DDR3 (64*16*8)	SO4GBIII10	SO2GBIII10	N
AS8943G-436G1TBn	Spain	LX.PU102.050	1G-DDR3 (64*16*8)	SO4GBIII10	SO2GBIII10	N
AS8943G-436G1TBn	Switzerland	LX.PU102.068	1G-DDR3 (64*16*8)	SO4GBIII10	SO2GBIII10	N
AS8943G-436G1TBn	Turkey	LX.PU102.085	1G-DDR3 (64*16*8)	SO4GBIII10	SO2GBIII10	N
AS8943G-436G1TBn	UK	LX.PU102.063	1G-DDR3 (64*16*8)	SO4GBIII10	SO2GBIII10	N
AS8943G-436G1TBn	Ukraine	LX.PU102.090	1G-DDR3 (64*16*8)	SO4GBIII10	SO2GBIII10	N
AS8943G-436G1TWn	Turkey	LX.PU102.098	1G-DDR3 (64*16*8)	SO4GBIII10	SO2GBIII10	N
AS8943G-438G1TBn	Switzerland	LX.PU102.096	1G-DDR3 (64*16*8)	SO4GBIII10	SO4GBIII10	N
AS8943G-438G64Bn	Switzerland	LX.PU102.095	1G-DDR3 (64*16*8)	SO4GBIII10	SO4GBIII10	N
AS8943G-524G64Mn	WW	S2.PTL02.002	1G-DDR3 (64*16*8)	SO2GBIII10	SO2GBIII10	N
AS8943G-524G64Mn	WW	S2.PTL02.002	1G-DDR3 (64*16*8)	SO2GBIII10	SO2GBIII10	N
AS8943G-524G64Mn	WW	S2.PTJ02.002	1G-DDR3 (64*16*8)	SO2GBIII10	SO2GBIII10	N

Model	Country	Acer P/N	VRAM 1	Memory 1	Memory 2	Memory 3
AS8943G-524G64Mn	WW	S2.PTJ02.002	1G-DDR3 (64*16*8)	SO2GBIII10	SO2GBIII10	N
AS8943G-526G1TWn	Turkey	LX.PU102.102	1G-DDR3 (64*16*8)	SO4GBIII10	SO2GBIII10	N
AS8943G-526G64Mn	Turkey	LX.PUJ02.057	1G-DDR3 (64*16*8)	SO4GBIII10	SO2GBIII10	N
AS8943G-544G1TMn	WW	S2.PUJ02.001	1G-DDR3 (64*16*8)	SO2GBIII10	SO2GBIII10	N
AS8943G-544G1TMn	WW	S2.PUJ02.001	1G-DDR3 (64*16*8)	SO2GBIII10	SO2GBIII10	N
AS8943G-544G64Bn	WW	S2.PTJ02.001	1G-DDR3 (64*16*8)	SO2GBIII10	SO2GBIII10	N
AS8943G-544G64Bn	WW	S2.PTJ02.001	1G-DDR3 (64*16*8)	SO2GBIII10	SO2GBIII10	N
AS8943G-624G1.28T Bn	France	LX.PU102.093	1G-DDR3 (64*16*8)	SO2GBIII10	SO2GBIII10	N
AS8943G-624G1TMn	France	LX.PU102.094	1G-DDR3 (64*16*8)	SO2GBIII10	SO2GBIII10	N
AS8943G-624G64Mn	China	LX.PU202.001	1G-DDR3 (64*16*8)	SO2GBIII10	SO2GBIII10	N
AS8943G-624G64Mn	Hong Kong	LX.PU102.091	1G-DDR3 (64*16*8)	SO2GBIII10	SO2GBIII10	N
AS8943G-626G1TWn	Turkey	LX.PUJ02.005	1G-DDR3 (64*16*8)	SO4GBIII10	SO2GBIII10	N
AS8943G-626G1TWn	Turkey	LX.PU102.101	1G-DDR3 (64*16*8)	SO4GBIII10	SO2GBIII10	N
AS8943G-628G1TMn	WW	S2.PU202.001	1G-DDR3 (64*16*8)	SO4GBIII10	SO4GBIII10	N
AS8943G-628G1TMn	WW	S2.PU202.001	1G-DDR3 (64*16*8)	SO4GBIII10	SO4GBIII10	N
AS8943G-72101.28T Wn	Singapore	LX.PUH02.236	1G-DDR3 (64*16*8)	SO4GBIII10	SO4GBIII10	SO2GBII110
AS8943G-72101.28T Wn	Singapore	LX.PUG02.010	1G-DDR3 (64*16*8)	SO4GBIII10	SO4GBIII10	SO2GBII110
AS8943G-72161.28T Wn	Belgium	LX.PUH02.246	1G-DDR3 (64*16*8)	SO4GBIII10	SO4GBIII10	SO4GBII110
AS8943G-72161.28T Wn	Germany	LX.PUH02.188	1G-DDR3 (64*16*8)	SO4GBIII10	SO4GBIII10	SO4GBII110
AS8943G-72161.28T Wn	Holland	LX.PUH02.245	1G-DDR3 (64*16*8)	SO4GBIII10	SO4GBIII10	SO4GBII110
AS8943G-72161.28T Wn	Luxembourg	LX.PUH02.244	1G-DDR3 (64*16*8)	SO4GBIII10	SO4GBIII10	SO4GBII110

Model	Country	Acer P/N	VRAM 1	Memory 1	Memory 2	Memory 3
AS8943G-72161.28T Wn	Singapore	LX.PUH02.190	1G-DDR3 (64*16*8)	SO4GBIII10	SO4GBIII10	SO4GBII110
AS8943G-72161.28T Wn	Singapore	LX.PUG02.009	1G-DDR3 (64*16*8)	SO4GBIII10	SO4GBIII10	SO4GBII110
AS8943G-72161.28T Wn	Spain	LX.PUG02.003	1G-DDR3 (64*16*8)	SO4GBIII10	SO4GBIII10	SO4GBII110
AS8943G-72161.28T Wn	UK	LX.PUG02.014	1G-DDR3 (64*16*8)	SO4GBIII10	SO4GBIII10	SO4GBII110
AS8943G-721632Wn	Poland	LX.PUH02.255	1G-DDR3 (64*16*8)	SO4GBIII10	SO4GBIII10	SO4GBII110
AS8943G-721682Bn	WW	S2.PUG02.002	1G-DDR3 (64*16*8)	SO4GBIII10	SO4GBIII10	SO4GBII110
AS8943G-721682Bn	WW	S2.PUG02.002	1G-DDR3 (64*16*8)	SO4GBIII10	SO4GBIII10	SO4GBII110
AS8943G-724G1TBn	Belgium	LX.PUH02.249	1G-DDR3 (64*16*8)	SO2GBIII10	SO2GBIII10	N
AS8943G-724G1TBn	GCTWN	LX.PUH02.183	1G-DDR3 (64*16*8)	SO4GBIII10	N	N
AS8943G-724G1TBn	GCTWN	LX.PUH02.182	1G-DDR3 (64*16*8)	SO2GBIII10	SO2GBIII10	N
AS8943G-724G1TBn	Germany	LX.PUH02.239	1G-DDR3 (64*16*8)	SO2GBIII10	SO2GBIII10	N
AS8943G-724G1TBn	Holland	LX.PUH02.248	1G-DDR3 (64*16*8)	SO2GBIII10	SO2GBIII10	N
AS8943G-724G1TBn	Hong Kong	LX.PUH02.181	1G-DDR3 (64*16*8)	SO2GBIII10	SO2GBIII10	N
AS8943G-724G1TBn	Luxembourg	LX.PUH02.247	1G-DDR3 (64*16*8)	SO2GBIII10	SO2GBIII10	N
AS8943G-724G1TMn	Algeria	LX.PUH02.226	1G-DDR3 (64*16*8)	SO2GBIII10	SO2GBIII10	N
AS8943G-724G1TMn	Austria	LX.PUH02.193	1G-DDR3 (64*16*8)	SO2GBIII10	SO2GBIII10	N
AS8943G-724G1TMn	Baltic	LX.PUH02.218	1G-DDR3 (64*16*8)	SO2GBIII10	SO2GBIII10	N
AS8943G-724G1TMn	Baltic	LX.PUH02.205	1G-DDR3 (64*16*8)	SO2GBIII10	SO2GBIII10	N
AS8943G-724G1TMn	Baltic	LX.PUH02.202	1G-DDR3 (64*16*8)	SO2GBIII10	SO2GBIII10	N
AS8943G-724G1TMn	Belgium	LX.PUH02.216	1G-DDR3 (64*16*8)	SO2GBIII10	SO2GBIII10	N
AS8943G-724G1TMn	Cyprus	LX.PUH02.203	1G-DDR3 (64*16*8)	SO2GBIII10	SO2GBIII10	N
AS8943G-724G1TMn	Czech	LX.PUH02.208	1G-DDR3 (64*16*8)	SO2GBIII10	SO2GBIII10	N
AS8943G-724G1TMn	Denmark	LX.PUH02.197	1G-DDR3 (64*16*8)	SO2GBIII10	SO2GBIII10	N

Model	Country	Acer P/N	VRAM 1	Memory 1	Memory 2	Memory 3
AS8943G-724G1TMn	Eastern Europe	LX.PUH02.210	1G-DDR3 (64*16*8)	SO2GBIII10	SO2GBIII10	N
AS8943G-724G1TMn	Eastern Europe	LX.PUH02.209	1G-DDR3 (64*16*8)	SO2GBIII10	SO2GBIII10	N
AS8943G-724G1TMn	Eastern Europe	LX.PUH02.196	1G-DDR3 (64*16*8)	SO2GBIII10	SO2GBIII10	N
AS8943G-724G1TMn	Eastern Europe	LX.PUH02.195	1G-DDR3 (64*16*8)	SO2GBIII10	SO2GBIII10	N
AS8943G-724G1TMn	Eastern Europe	LX.PUH02.191	1G-DDR3 (64*16*8)	SO2GBIII10	SO2GBIII10	N
AS8943G-724G1TMn	France	LX.PUH02.192	1G-DDR3 (64*16*8)	SO2GBIII10	SO2GBIII10	N
AS8943G-724G1TMn	Germany	LX.PUH02.220	1G-DDR3 (64*16*8)	SO2GBIII10	SO2GBIII10	N
AS8943G-724G1TMn	Greece	LX.PUH02.194	1G-DDR3 (64*16*8)	SO2GBIII10	SO2GBIII10	N
AS8943G-724G1TMn	Holland	LX.PUH02.217	1G-DDR3 (64*16*8)	SO2GBIII10	SO2GBIII10	N
AS8943G-724G1TMn	Hungary	LX.PUH02.207	1G-DDR3 (64*16*8)	SO2GBIII10	SO2GBIII10	N
AS8943G-724G1TMn	Israel	LX.PUH02.206	1G-DDR3 (64*16*8)	SO2GBIII10	SO2GBIII10	N
AS8943G-724G1TMn	Italy	LX.PUH02.199	1G-DDR3 (64*16*8)	SO2GBIII10	SO2GBIII10	N
AS8943G-724G1TMn	Latvia	LX.PUH02.213	1G-DDR3 (64*16*8)	SO2GBIII10	SO2GBIII10	N
AS8943G-724G1TMn	Latvia	LX.PUH02.212	1G-DDR3 (64*16*8)	SO2GBIII10	SO2GBIII10	N
AS8943G-724G1TMn	Luxembourg	LX.PUH02.214	1G-DDR3 (64*16*8)	SO2GBIII10	SO2GBIII10	N
AS8943G-724G1TMn	Middle East	LX.PUH02.235	1G-DDR3 (64*16*8)	SO2GBIII10	SO2GBIII10	N
AS8943G-724G1TMn	Middle East	LX.PUH02.234	1G-DDR3 (64*16*8)	SO2GBIII10	SO2GBIII10	N
AS8943G-724G1TMn	Middle East	LX.PUH02.231	1G-DDR3 (64*16*8)	SO2GBIII10	SO2GBIII10	N
AS8943G-724G1TMn	Middle East	LX.PUH02.230	1G-DDR3 (64*16*8)	SO2GBIII10	SO2GBIII10	N
AS8943G-724G1TMn	Middle East	LX.PUH02.228	1G-DDR3 (64*16*8)	SO2GBIII10	SO2GBIII10	N
AS8943G-724G1TMn	Middle East	LX.PUH02.227	1G-DDR3 (64*16*8)	SO2GBIII10	SO2GBIII10	N
AS8943G-724G1TMn	Middle East	LX.PUH02.224	1G-DDR3 (64*16*8)	SO2GBIII10	SO2GBIII10	N
AS8943G-724G1TMn	Middle East	LX.PUH02.223	1G-DDR3 (64*16*8)	SO2GBIII10	SO2GBIII10	N
AS8943G-724G1TMn	Middle East	LX.PUH02.222	1G-DDR3 (64*16*8)	SO2GBIII10	SO2GBIII10	N

Model	Country	Acer P/N	VRAM 1	Memory 1	Memory 2	Memory 3
AS8943G-724G1TMn	Poland	LX.PUH02.219	1G-DDR3 (64*16*8)	SO2GBIII10	SO2GBIII10	N
AS8943G-724G1TMn	Portugal	LX.PUH02.204	1G-DDR3 (64*16*8)	SO2GBIII10	SO2GBIII10	N
AS8943G-724G1TMn	Serbia/Macedonia	LX.PUH02.201	1G-DDR3 (64*16*8)	SO2GBIII10	SO2GBIII10	N
AS8943G-724G1TMn	South Africa	LX.PUH02.233	1G-DDR3 (64*16*8)	SO2GBIII10	SO2GBIII10	N
AS8943G-724G1TMn	South Africa	LX.PUH02.229	1G-DDR3 (64*16*8)	SO2GBIII10	SO2GBIII10	N
AS8943G-724G1TMn	South Africa	LX.PUH02.225	1G-DDR3 (64*16*8)	SO2GBIII10	SO2GBIII10	N
AS8943G-724G1TMn	South Africa	LX.PUH02.221	1G-DDR3 (64*16*8)	SO2GBIII10	SO2GBIII10	N
AS8943G-724G1TMn	Spain	LX.PUH02.198	1G-DDR3 (64*16*8)	SO2GBIII10	SO2GBIII10	N
AS8943G-724G1TMn	Switzerland	LX.PUH02.215	1G-DDR3 (64*16*8)	SO2GBIII10	SO2GBIII10	N
AS8943G-724G1TMn	Turkey	LX.PUH02.232	1G-DDR3 (64*16*8)	SO2GBIII10	SO2GBIII10	N
AS8943G-724G1TMn	UK	LX.PUH02.211	1G-DDR3 (64*16*8)	SO2GBIII10	SO2GBIII10	N
AS8943G-724G1TWn	Hong Kong	LX.PUH02.238	1G-DDR3 (64*16*8)	SO2GBIII10	SO2GBIII10	N
AS8943G-724G50Bn	USA	LX.PWC02.074	1G-DDR3 (64*16*8)	SO2GBIII10	SO2GBIII10	N
AS8943G-724G50Mn	USA	LX.PWC02.070	1G-DDR3 (64*16*8)	SO2GBIII10	SO2GBIII10	N
AS8943G-724G64Bn	Middle East	LX.PWC02.069	1G-DDR3 (64*16*8)	SO2GBIII10	SO2GBIII10	N
AS8943G-724G64Bn	UK	LX.PWC02.076	1G-DDR3 (64*16*8)	SO2GBIII10	SO2GBIII10	N
AS8943G-724G64Mi	Russia	LX.PWC02.066	1G-DDR3 (64*16*8)	SO2GBIII10	SO2GBIII10	N
AS8943G-724G64Mi	Russia	LX.PUH02.045	1G-DDR3 (64*16*8)	SO2GBIII10	SO2GBIII10	N
AS8943G-724G64Mn	Algeria	LX.PWC02.047	1G-DDR3 (64*16*8)	SO2GBIII10	SO2GBIII10	N
AS8943G-724G64Mn	Algeria	LX.PUH02.037	1G-DDR3 (64*16*8)	SO2GBIII10	SO2GBIII10	N
AS8943G-724G64Mn	Austria	LX.PWC02.005	1G-DDR3 (64*16*8)	SO2GBIII10	SO2GBIII10	N
AS8943G-724G64Mn	Austria	LX.PUH02.009	1G-DDR3 (64*16*8)	SO2GBIII10	SO2GBIII10	N
AS8943G-724G64Mn	Baltic	LX.PWC02.058	1G-DDR3 (64*16*8)	SO2GBIII10	SO2GBIII10	N
AS8943G-724G64Mn	Baltic	LX.PWC02.027	1G-DDR3 (64*16*8)	SO2GBIII10	SO2GBIII10	N

Model	Country	Acer P/N	VRAM 1	Memory 1	Memory 2	Memory 3
AS8943G-724G64Mn	Baltic	LX.PWC02.024	1G-DDR3 (64*16*8)	SO2GBIII10	SO2GBIII10	N
AS8943G-724G64Mn	Baltic	LX.PUH02.028	1G-DDR3 (64*16*8)	SO2GBIII10	SO2GBIII10	N
AS8943G-724G64Mn	Baltic	LX.PUH02.020	1G-DDR3 (64*16*8)	SO2GBIII10	SO2GBIII10	N
AS8943G-724G64Mn	Baltic	LX.PUH02.017	1G-DDR3 (64*16*8)	SO2GBIII10	SO2GBIII10	N
AS8943G-724G64Mn	Belgium	LX.PWC02.055	1G-DDR3 (64*16*8)	SO2GBIII10	SO2GBIII10	N
AS8943G-724G64Mn	Belgium	LX.PUH02.025	1G-DDR3 (64*16*8)	SO2GBIII10	SO2GBIII10	N
AS8943G-724G64Mn	China	LX.PUH02.001	1G-DDR3 (64*16*8)	SO2GBIII10	SO2GBIII10	N
AS8943G-724G64Mn	Cyprus	LX.PWC02.025	1G-DDR3 (64*16*8)	SO2GBIII10	SO2GBIII10	N
AS8943G-724G64Mn	Cyprus	LX.PUH02.019	1G-DDR3 (64*16*8)	SO2GBIII10	SO2GBIII10	N
AS8943G-724G64Mn	Czech	LX.PWC02.030	1G-DDR3 (64*16*8)	SO2GBIII10	SO2GBIII10	N
AS8943G-724G64Mn	Czech	LX.PUH02.004	1G-DDR3 (64*16*8)	SO2GBIII10	SO2GBIII10	N
AS8943G-724G64Mn	Denmark	LX.PWC02.012	1G-DDR3 (64*16*8)	SO2GBIII10	SO2GBIII10	N
AS8943G-724G64Mn	Denmark	LX.PUH02.015	1G-DDR3 (64*16*8)	SO2GBIII10	SO2GBIII10	N
AS8943G-724G64Mn	Eastern Europe	LX.PWC02.040	1G-DDR3 (64*16*8)	SO2GBIII10	SO2GBIII10	N
AS8943G-724G64Mn	Eastern Europe	LX.PWC02.037	1G-DDR3 (64*16*8)	SO2GBIII10	SO2GBIII10	N
AS8943G-724G64Mn	Eastern Europe	LX.PWC02.011	1G-DDR3 (64*16*8)	SO2GBIII10	SO2GBIII10	N
AS8943G-724G64Mn	Eastern Europe	LX.PWC02.008	1G-DDR3 (64*16*8)	SO2GBIII10	SO2GBIII10	N
AS8943G-724G64Mn	Eastern Europe	LX.PWC02.001	1G-DDR3 (64*16*8)	SO2GBIII10	SO2GBIII10	N
AS8943G-724G64Mn	Eastern Europe	LX.PUH02.021	1G-DDR3 (64*16*8)	SO2GBIII10	SO2GBIII10	N
AS8943G-724G64Mn	Eastern Europe	LX.PUH02.014	1G-DDR3 (64*16*8)	SO2GBIII10	SO2GBIII10	N
AS8943G-724G64Mn	Eastern Europe	LX.PUH02.013	1G-DDR3 (64*16*8)	SO2GBIII10	SO2GBIII10	N
AS8943G-724G64Mn	Eastern Europe	LX.PUH02.008	1G-DDR3 (64*16*8)	SO2GBIII10	SO2GBIII10	N
AS8943G-724G64Mn	Eastern Europe	LX.PUH02.006	1G-DDR3 (64*16*8)	SO2GBIII10	SO2GBIII10	N
AS8943G-724G64Mn	France	LX.PWC02.004	1G-DDR3 (64*16*8)	SO2GBIII10	SO2GBIII10	N

Model	Country	Acer P/N	VRAM 1	Memory 1	Memory 2	Memory 3
AS8943G-724G64Mn	France	LX.PUH02.007	1G-DDR3 (64*16*8)	SO2GBIII10	SO2GBIII10	N
AS8943G-724G64Mn	Germany	LX.PWC02.061	1G-DDR3 (64*16*8)	SO2GBIII10	SO2GBIII10	N
AS8943G-724G64Mn	Germany	LX.PUH02.029	1G-DDR3 (64*16*8)	SO2GBIII10	SO2GBIII10	N
AS8943G-724G64Mn	Greece	LX.PWC02.007	1G-DDR3 (64*16*8)	SO2GBIII10	SO2GBIII10	N
AS8943G-724G64Mn	Greece	LX.PUH02.010	1G-DDR3 (64*16*8)	SO2GBIII10	SO2GBIII10	N
AS8943G-724G64Mn	Holland	LX.PWC02.056	1G-DDR3 (64*16*8)	SO2GBIII10	SO2GBIII10	N
AS8943G-724G64Mn	Holland	LX.PUH02.026	1G-DDR3 (64*16*8)	SO2GBIII10	SO2GBIII10	N
AS8943G-724G64Mn	Hungary	LX.PWC02.029	1G-DDR3 (64*16*8)	SO2GBIII10	SO2GBIII10	N
AS8943G-724G64Mn	Hungary	LX.PUH02.003	1G-DDR3 (64*16*8)	SO2GBIII10	SO2GBIII10	N
AS8943G-724G64Mn	Israel	LX.PWC02.028	1G-DDR3 (64*16*8)	SO2GBIII10	SO2GBIII10	N
AS8943G-724G64Mn	Israel	LX.PUH02.002	1G-DDR3 (64*16*8)	SO2GBIII10	SO2GBIII10	N
AS8943G-724G64Mn	Italy	LX.PWC02.018	1G-DDR3 (64*16*8)	SO2GBIII10	SO2GBIII10	N
AS8943G-724G64Mn	Italy	LX.PUH02.012	1G-DDR3 (64*16*8)	SO2GBIII10	SO2GBIII10	N
AS8943G-724G64Mn	Latvia	LX.PWC02.043	1G-DDR3 (64*16*8)	SO2GBIII10	SO2GBIII10	N
AS8943G-724G64Mn	Latvia	LX.PWC02.042	1G-DDR3 (64*16*8)	SO2GBIII10	SO2GBIII10	N
AS8943G-724G64Mn	Latvia	LX.PUH02.023	1G-DDR3 (64*16*8)	SO2GBIII10	SO2GBIII10	N
AS8943G-724G64Mn	Latvia	LX.PUH02.022	1G-DDR3 (64*16*8)	SO2GBIII10	SO2GBIII10	N
AS8943G-724G64Mn	Luxembourg	LX.PWC02.044	1G-DDR3 (64*16*8)	SO2GBIII10	SO2GBIII10	N
AS8943G-724G64Mn	Luxembourg	LX.PUH02.027	1G-DDR3 (64*16*8)	SO2GBIII10	SO2GBIII10	N
AS8943G-724G64Mn	Middle East	LX.PWC02.065	1G-DDR3 (64*16*8)	SO2GBIII10	SO2GBIII10	N
AS8943G-724G64Mn	Middle East	LX.PWC02.064	1G-DDR3 (64*16*8)	SO2GBIII10	SO2GBIII10	N
AS8943G-724G64Mn	Middle East	LX.PWC02.051	1G-DDR3 (64*16*8)	SO2GBIII10	SO2GBIII10	N
AS8943G-724G64Mn	Middle East	LX.PWC02.050	1G-DDR3 (64*16*8)	SO2GBIII10	SO2GBIII10	N
AS8943G-724G64Mn	Middle East	LX.PWC02.048	1G-DDR3 (64*16*8)	SO2GBIII10	SO2GBIII10	N

Model	Country	Acer P/N	VRAM 1	Memory 1	Memory 2	Memory 3
AS8943G-724G64Mn	Middle East	LX.PWC02.035	1G-DDR3 (64*16*8)	SO2GBIII10	SO2GBIII10	N
AS8943G-724G64Mn	Middle East	LX.PWC02.034	1G-DDR3 (64*16*8)	SO2GBIII10	SO2GBIII10	N
AS8943G-724G64Mn	Middle East	LX.PWC02.033	1G-DDR3 (64*16*8)	SO2GBIII10	SO2GBIII10	N
AS8943G-724G64Mn	Middle East	LX.PWC02.032	1G-DDR3 (64*16*8)	SO2GBIII10	SO2GBIII10	N
AS8943G-724G64Mn	Middle East	LX.PUH02.044	1G-DDR3 (64*16*8)	SO2GBIII10	SO2GBIII10	N
AS8943G-724G64Mn	Middle East	LX.PUH02.043	1G-DDR3 (64*16*8)	SO2GBIII10	SO2GBIII10	N
AS8943G-724G64Mn	Middle East	LX.PUH02.040	1G-DDR3 (64*16*8)	SO2GBIII10	SO2GBIII10	N
AS8943G-724G64Mn	Middle East	LX.PUH02.039	1G-DDR3 (64*16*8)	SO2GBIII10	SO2GBIII10	N
AS8943G-724G64Mn	Middle East	LX.PUH02.038	1G-DDR3 (64*16*8)	SO2GBIII10	SO2GBIII10	N
AS8943G-724G64Mn	Middle East	LX.PUH02.035	1G-DDR3 (64*16*8)	SO2GBIII10	SO2GBIII10	N
AS8943G-724G64Mn	Middle East	LX.PUH02.034	1G-DDR3 (64*16*8)	SO2GBIII10	SO2GBIII10	N
AS8943G-724G64Mn	Middle East	LX.PUH02.033	1G-DDR3 (64*16*8)	SO2GBIII10	SO2GBIII10	N
AS8943G-724G64Mn	Middle East	LX.PUH02.032	1G-DDR3 (64*16*8)	SO2GBIII10	SO2GBIII10	N
AS8943G-724G64Mn	Poland	LX.PWC02.059	1G-DDR3 (64*16*8)	SO2GBIII10	SO2GBIII10	N
AS8943G-724G64Mn	Poland	LX.PUH02.030	1G-DDR3 (64*16*8)	SO2GBIII10	SO2GBIII10	N
AS8943G-724G64Mn	Portugal	LX.PWC02.026	1G-DDR3 (64*16*8)	SO2GBIII10	SO2GBIII10	N
AS8943G-724G64Mn	Portugal	LX.PUH02.018	1G-DDR3 (64*16*8)	SO2GBIII10	SO2GBIII10	N
AS8943G-724G64Mn	Serbia/ Macedonia	LX.PWC02.019	1G-DDR3 (64*16*8)	SO2GBIII10	SO2GBIII10	N
AS8943G-724G64Mn	Serbia/ Macedonia	LX.PUH02.016	1G-DDR3 (64*16*8)	SO2GBIII10	SO2GBIII10	N
AS8943G-724G64Mn	South Africa	LX.PWC02.063	1G-DDR3 (64*16*8)	SO2GBIII10	SO2GBIII10	N
AS8943G-724G64Mn	South Africa	LX.PWC02.049	1G-DDR3 (64*16*8)	SO2GBIII10	SO2GBIII10	N
AS8943G-724G64Mn	South Africa	LX.PWC02.046	1G-DDR3 (64*16*8)	SO2GBIII10	SO2GBIII10	N
AS8943G-724G64Mn	South Africa	LX.PWC02.031	1G-DDR3 (64*16*8)	SO2GBIII10	SO2GBIII10	N
AS8943G-724G64Mn	South Africa	LX.PUH02.042	1G-DDR3 (64*16*8)	SO2GBIII10	SO2GBIII10	N

Model	Country	Acer P/N	VRAM 1	Memory 1	Memory 2	Memory 3
AS8943G-724G64Mn	South Africa	LX.PUH02.036	1G-DDR3 (64*16*8)	SO2GBIII10	SO2GBIII10	N
AS8943G-724G64Mn	South Africa	LX.PUH02.031	1G-DDR3 (64*16*8)	SO2GBIII10	SO2GBIII10	N
AS8943G-724G64Mn	Spain	LX.PWC02.015	1G-DDR3 (64*16*8)	SO2GBIII10	SO2GBIII10	N
AS8943G-724G64Mn	Spain	LX.PUH02.011	1G-DDR3 (64*16*8)	SO2GBIII10	SO2GBIII10	N
AS8943G-724G64Mn	Switzerland	LX.PWC02.045	1G-DDR3 (64*16*8)	SO2GBIII10	SO2GBIII10	N
AS8943G-724G64Mn	Switzerland	LX.PUH02.024	1G-DDR3 (64*16*8)	SO2GBIII10	SO2GBIII10	N
AS8943G-724G64Mn	Turkey	LX.PWC02.062	1G-DDR3 (64*16*8)	SO2GBIII10	SO2GBIII10	N
AS8943G-724G64Mn	Turkey	LX.PUH02.041	1G-DDR3 (64*16*8)	SO2GBIII10	SO2GBIII10	N
AS8943G-724G64Mn	UK	LX.PWC02.041	1G-DDR3 (64*16*8)	SO2GBIII10	SO2GBIII10	N
AS8943G-724G64Mn	UK	LX.PUH02.005	1G-DDR3 (64*16*8)	SO2GBIII10	SO2GBIII10	N
AS8943G-724G64Mn	Ukraine	LX.PWC02.067	1G-DDR3 (64*16*8)	SO2GBIII10	SO2GBIII10	N
AS8943G-724G64Mn	Ukraine	LX.PUH02.046	1G-DDR3 (64*16*8)	SO2GBIII10	SO2GBIII10	N
AS8943G-724G64Wn	China	LX.PUH02.237	1G-DDR3 (64*16*8)	SO2GBIII10	SO2GBIII10	N
AS8943G-724G64Wn	Middle East	LX.PWC02.068	1G-DDR3 (64*16*8)	SO2GBIII10	SO2GBIII10	N
AS8943G-726G1.28T Bn	Belgium	LX.PWC02.071	1G-DDR3 (64*16*8)	SO2GBIII10	SO2GBIII10	SO2GBII110
AS8943G-726G1.28T Bn	Belgium	LX.PUH02.241	1G-DDR3 (64*16*8)	SO2GBIII10	SO2GBIII10	SO2GBII110
AS8943G-726G1.28T Bn	Holland	LX.PWC02.073	1G-DDR3 (64*16*8)	SO2GBIII10	SO2GBIII10	SO2GBII110
AS8943G-726G1.28T Bn	Holland	LX.PUH02.240	1G-DDR3 (64*16*8)	SO2GBIII10	SO2GBIII10	SO2GBII110
AS8943G-726G1.28T Bn	Luxembourg	LX.PWC02.072	1G-DDR3 (64*16*8)	SO2GBIII10	SO2GBIII10	SO2GBII110
AS8943G-726G1.28T Bn	Luxembourg	LX.PUH02.242	1G-DDR3 (64*16*8)	SO2GBIII10	SO2GBIII10	SO2GBII110
AS8943G-726G64Wn	Australia/ New Zealand	LX.PUG02.006	1G-DDR3 (64*16*8)	SO2GBIII10	SO2GBIII10	SO2GBII110

Model	Country	Acer P/N	VRAM 1	Memory 1	Memory 2	Memory 3
AS8943G-728G1.14T Bn	Spain	LX.PUG02.001	1G-DDR3 (64*16*8)	SO2GBIII10	SO2GBIII10	SO2GBII110
AS8943G-728G1.28T Bn	Algeria	LX.PUH02.173	1G-DDR3 (64*16*8)	SO2GBIII10	SO2GBIII10	SO2GBII110
AS8943G-728G1.28T Bn	Austria	LX.PUH02.140	1G-DDR3 (64*16*8)	SO2GBIII10	SO2GBIII10	SO2GBII110
AS8943G-728G1.28T Bn	Baltic	LX.PUH02.164	1G-DDR3 (64*16*8)	SO2GBIII10	SO2GBIII10	SO2GBII110
AS8943G-728G1.28T Bn	Baltic	LX.PUH02.151	1G-DDR3 (64*16*8)	SO2GBIII10	SO2GBIII10	SO2GBII110
AS8943G-728G1.28T Bn	Baltic	LX.PUH02.148	1G-DDR3 (64*16*8)	SO2GBIII10	SO2GBIII10	SO2GBII110
AS8943G-728G1.28T Bn	Belgium	LX.PUH02.161	1G-DDR3 (64*16*8)	SO2GBIII10	SO2GBIII10	SO2GBII110
AS8943G-728G1.28T Bn	Cyprus	LX.PUH02.150	1G-DDR3 (64*16*8)	SO2GBIII10	SO2GBIII10	SO2GBII110
AS8943G-728G1.28T Bn	Czech	LX.PUH02.154	1G-DDR3 (64*16*8)	SO2GBIII10	SO2GBIII10	SO2GBII110
AS8943G-728G1.28T Bn	Denmark	LX.PUH02.146	1G-DDR3 (64*16*8)	SO2GBIII10	SO2GBIII10	SO2GBII110
AS8943G-728G1.28T Bn	Eastern Europe	LX.PUH02.157	1G-DDR3 (64*16*8)	SO2GBIII10	SO2GBIII10	SO2GBII110
AS8943G-728G1.28T Bn	Eastern Europe	LX.PUH02.156	1G-DDR3 (64*16*8)	SO2GBIII10	SO2GBIII10	SO2GBII110
AS8943G-728G1.28T Bn	Eastern Europe	LX.PUH02.145	1G-DDR3 (64*16*8)	SO2GBIII10	SO2GBIII10	SO2GBII110
AS8943G-728G1.28T Bn	Eastern Europe	LX.PUH02.144	1G-DDR3 (64*16*8)	SO2GBIII10	SO2GBIII10	SO2GBII110
AS8943G-728G1.28T Bn	Eastern Europe	LX.PUH02.139	1G-DDR3 (64*16*8)	SO2GBIII10	SO2GBIII10	SO2GBII110
AS8943G-728G1.28T Bn	France	LX.PUH02.138	1G-DDR3 (64*16*8)	SO2GBIII10	SO2GBIII10	SO2GBII110
AS8943G-728G1.28T Bn	Germany	LX.PUH02.165	1G-DDR3 (64*16*8)	SO2GBIII10	SO2GBIII10	SO2GBII110

Model	Country	Acer P/N	VRAM 1	Memory 1	Memory 2	Memory 3
AS8943G-728G1.28T Bn	Greece	LX.PUH02.141	1G-DDR3 (64*16*8)	SO2GBIII10	SO2GBIII10	SO2GBII110
AS8943G-728G1.28T Bn	Holland	LX.PUH02.162	1G-DDR3 (64*16*8)	SO2GBIII10	SO2GBIII10	SO2GBII110
AS8943G-728G1.28T Bn	Hungary	LX.PUH02.153	1G-DDR3 (64*16*8)	SO2GBIII10	SO2GBIII10	SO2GBII110
AS8943G-728G1.28T Bn	Israel	LX.PUH02.152	1G-DDR3 (64*16*8)	SO2GBIII10	SO2GBIII10	SO2GBII110
AS8943G-728G1.28T Bn	Italy	LX.PUH02.143	1G-DDR3 (64*16*8)	SO2GBIII10	SO2GBIII10	SO2GBII110
AS8943G-728G1.28T Bn	Latvia	LX.PUH02.159	1G-DDR3 (64*16*8)	SO2GBIII10	SO2GBIII10	SO2GBII110
AS8943G-728G1.28T Bn	Latvia	LX.PUH02.158	1G-DDR3 (64*16*8)	SO2GBIII10	SO2GBIII10	SO2GBII110
AS8943G-728G1.28T Bn	Luxembourg	LX.PUH02.163	1G-DDR3 (64*16*8)	SO2GBIII10	SO2GBIII10	SO2GBII110
AS8943G-728G1.28T Bn	Middle East	LX.PUH02.180	1G-DDR3 (64*16*8)	SO2GBIII10	SO2GBIII10	SO2GBII110
AS8943G-728G1.28T Bn	Middle East	LX.PUH02.179	1G-DDR3 (64*16*8)	SO2GBIII10	SO2GBIII10	SO2GBII110
AS8943G-728G1.28T Bn	Middle East	LX.PUH02.176	1G-DDR3 (64*16*8)	SO2GBIII10	SO2GBIII10	SO2GBII110
AS8943G-728G1.28T Bn	Middle East	LX.PUH02.175	1G-DDR3 (64*16*8)	SO2GBIII10	SO2GBIII10	SO2GBII110
AS8943G-728G1.28T Bn	Middle East	LX.PUH02.174	1G-DDR3 (64*16*8)	SO2GBIII10	SO2GBIII10	SO2GBII110
AS8943G-728G1.28T Bn	Middle East	LX.PUH02.171	1G-DDR3 (64*16*8)	SO2GBIII10	SO2GBIII10	SO2GBII110
AS8943G-728G1.28T Bn	Middle East	LX.PUH02.170	1G-DDR3 (64*16*8)	SO2GBIII10	SO2GBIII10	SO2GBII110
AS8943G-728G1.28T Bn	Middle East	LX.PUH02.169	1G-DDR3 (64*16*8)	SO2GBIII10	SO2GBIII10	SO2GBII110
AS8943G-728G1.28T Bn	Middle East	LX.PUH02.168	1G-DDR3 (64*16*8)	SO2GBIII10	SO2GBIII10	SO2GBII110

Model	Country	Acer P/N	VRAM 1	Memory 1	Memory 2	Memory 3
AS8943G-728G1.28T Bn	Poland	LX.PUH02.166	1G-DDR3 (64*16*8)	SO2GBIII10	SO2GBIII10	SO2GBII110
AS8943G-728G1.28T Bn	Portugal	LX.PUH02.149	1G-DDR3 (64*16*8)	SO2GBIII10	SO2GBIII10	SO2GBII110
AS8943G-728G1.28T Bn	Serbia/ Macedonia	LX.PUH02.147	1G-DDR3 (64*16*8)	SO2GBIII10	SO2GBIII10	SO2GBII110
AS8943G-728G1.28T Bn	South Africa	LX.PUH02.178	1G-DDR3 (64*16*8)	SO2GBIII10	SO2GBIII10	SO2GBII110
AS8943G-728G1.28T Bn	South Africa	LX.PUH02.172	1G-DDR3 (64*16*8)	SO2GBIII10	SO2GBIII10	SO2GBII110
AS8943G-728G1.28T Bn	South Africa	LX.PUH02.167	1G-DDR3 (64*16*8)	SO2GBIII10	SO2GBIII10	SO2GBII110
AS8943G-728G1.28T Bn	Spain	LX.PUH02.142	1G-DDR3 (64*16*8)	SO2GBIII10	SO2GBIII10	SO2GBII110
AS8943G-728G1.28T Bn	Switzerland	LX.PUH02.160	1G-DDR3 (64*16*8)	SO2GBIII10	SO2GBIII10	SO2GBII110
AS8943G-728G1.28T Bn	Turkey	LX.PUH02.177	1G-DDR3 (64*16*8)	SO2GBIII10	SO2GBIII10	SO2GBII110
AS8943G-728G1.28T Bn	UK	LX.PUH02.155	1G-DDR3 (64*16*8)	SO2GBIII10	SO2GBIII10	SO2GBII110
AS8943G-728G1.28T Wi	Russia	LX.PUH02.254	1G-DDR3 (64*16*8)	SO2GBIII10	SO2GBIII10	SO2GBII110
AS8943G-728G1.28T Wn	Australia/ New Zealand	LX.PUG02.007	1G-DDR3 (64*16*8)	SO2GBIII10	SO2GBIII10	SO2GBII110
AS8943G-728G1.28T Wn	Czech	LX.PUG02.011	1G-DDR3 (64*16*8)	SO2GBIII10	SO2GBIII10	SO2GBII110
AS8943G-728G1.28T Wn	France	LX.PUG02.004	1G-DDR3 (64*16*8)	SO2GBIII10	SO2GBIII10	SO2GBII110
AS8943G-728G1.28T Wn	Germany	LX.PUH02.251	1G-DDR3 (64*16*8)	SO2GBIII10	SO2GBIII10	SO2GBII110
AS8943G-728G1.28T Wn	Philippines	LX.PUH02.250	1G-DDR3 (64*16*8)	SO4GBIII10	SO4GBIII10	N
AS8943G-728G1.28T Wn	Singapore	LX.PUH02.189	1G-DDR3 (64*16*8)	SO4GBIII10	SO4GBIII10	N

Model	Country	Acer P/N	VRAM 1	Memory 1	Memory 2	Memory 3
AS8943G-728G1.28T Wn	Singapore	LX.PUG02.008	1G-DDR3 (64*16*8)	SO4GBIII10	SO4GBIII10	N
AS8943G-728G1.28T Wn	Switzerland	LX.PUH02.185	1G-DDR3 (64*16*8)	SO2GBIII10	SO2GBIII10	SO2GBII110
AS8943G-728G1.28T Wn	Switzerland	LX.PUH02.184	1G-DDR3 (64*16*8)	SO2GBIII10	SO2GBIII10	SO2GBII110
AS8943G-728G1.28T Wn	Switzerland	LX.PUG02.005	1G-DDR3 (64*16*8)	SO2GBIII10	SO2GBIII10	SO2GBII110
AS8943G-728G1.28T Wn	Thailand	LX.PUH02.253	1G-DDR3 (64*16*8)	SO2GBIII10	SO2GBIII10	SO2GBII110
AS8943G-728G1.28T Wn	Thailand	LX.PUH02.252	1G-DDR3 (64*16*8)	SO4GBIII10	SO4GBIII10	N
AS8943G-728G1TBi	Russia	LX.PUH02.136	1G-DDR3 (64*16*8)	SO2GBIII10	SO2GBIII10	SO2GBII110
AS8943G-728G1TBn	Algeria	LX.PUH02.128	1G-DDR3 (64*16*8)	SO2GBIII10	SO2GBIII10	SO2GBII110
AS8943G-728G1TBn	Austria	LX.PUH02.094	1G-DDR3 (64*16*8)	SO2GBIII10	SO2GBIII10	SO2GBII110
AS8943G-728G1TBn	Baltic	LX.PUH02.119	1G-DDR3 (64*16*8)	SO2GBIII10	SO2GBIII10	SO2GBII110
AS8943G-728G1TBn	Baltic	LX.PUH02.102	1G-DDR3 (64*16*8)	SO2GBIII10	SO2GBIII10	SO2GBII110
AS8943G-728G1TBn	Baltic	LX.PUH02.098	1G-DDR3 (64*16*8)	SO2GBIII10	SO2GBIII10	SO2GBII110
AS8943G-728G1TBn	Belgium	LX.PUH02.116	1G-DDR3 (64*16*8)	SO2GBIII10	SO2GBIII10	SO2GBII110
AS8943G-728G1TBn	Cyprus	LX.PUH02.101	1G-DDR3 (64*16*8)	SO2GBIII10	SO2GBIII10	SO2GBII110
AS8943G-728G1TBn	Czech	LX.PUH02.105	1G-DDR3 (64*16*8)	SO2GBIII10	SO2GBIII10	SO2GBII110
AS8943G-728G1TBn	Denmark	LX.PUH02.096	1G-DDR3 (64*16*8)	SO2GBIII10	SO2GBIII10	SO2GBII110
AS8943G-728G1TBn	Eastern Europe	LX.PUH02.112	1G-DDR3 (64*16*8)	SO2GBIII10	SO2GBIII10	SO2GBII110
AS8943G-728G1TBn	Eastern Europe	LX.PUH02.111	1G-DDR3 (64*16*8)	SO2GBIII10	SO2GBIII10	SO2GBII110
AS8943G-728G1TBn	Eastern Europe	LX.PUH02.110	1G-DDR3 (64*16*8)	SO2GBIII10	SO2GBIII10	SO2GBII110
AS8943G-728G1TBn	Eastern Europe	LX.PUH02.107	1G-DDR3 (64*16*8)	SO2GBIII10	SO2GBIII10	SO2GBII110
AS8943G-728G1TBn	Eastern Europe	LX.PUH02.093	1G-DDR3 (64*16*8)	SO2GBIII10	SO2GBIII10	SO2GBII110
AS8943G-728G1TBn	France	LX.PUH02.092	1G-DDR3 (64*16*8)	SO2GBIII10	SO2GBIII10	SO2GBII110

Model	Country	Acer P/N	VRAM 1	Memory 1	Memory 2	Memory 3
AS8943G-728G1TBn	Germany	LX.PUH02.120	1G-DDR3 (64*16*8)	SO2GBIII10	SO2GBIII10	SO2GBII110
AS8943G-728G1TBn	Greece	LX.PUH02.095	1G-DDR3 (64*16*8)	SO2GBIII10	SO2GBIII10	SO2GBII110
AS8943G-728G1TBn	Holland	LX.PUH02.117	1G-DDR3 (64*16*8)	SO2GBIII10	SO2GBIII10	SO2GBII110
AS8943G-728G1TBn	Hungary	LX.PUH02.104	1G-DDR3 (64*16*8)	SO2GBIII10	SO2GBIII10	SO2GBII110
AS8943G-728G1TBn	Israel	LX.PUH02.103	1G-DDR3 (64*16*8)	SO2GBIII10	SO2GBIII10	SO2GBII110
AS8943G-728G1TBn	Italy	LX.PUH02.109	1G-DDR3 (64*16*8)	SO2GBIII10	SO2GBIII10	SO2GBII110
AS8943G-728G1TBn	Latvia	LX.PUH02.114	1G-DDR3 (64*16*8)	SO2GBIII10	SO2GBIII10	SO2GBII110
AS8943G-728G1TBn	Latvia	LX.PUH02.113	1G-DDR3 (64*16*8)	SO2GBIII10	SO2GBIII10	SO2GBII110
AS8943G-728G1TBn	Luxembourg	LX.PUH02.118	1G-DDR3 (64*16*8)	SO2GBIII10	SO2GBIII10	SO2GBII110
AS8943G-728G1TBn	Middle East	LX.PUH02.135	1G-DDR3 (64*16*8)	SO2GBIII10	SO2GBIII10	SO2GBII110
AS8943G-728G1TBn	Middle East	LX.PUH02.134	1G-DDR3 (64*16*8)	SO2GBIII10	SO2GBIII10	SO2GBII110
AS8943G-728G1TBn	Middle East	LX.PUH02.131	1G-DDR3 (64*16*8)	SO2GBIII10	SO2GBIII10	SO2GBII110
AS8943G-728G1TBn	Middle East	LX.PUH02.130	1G-DDR3 (64*16*8)	SO2GBIII10	SO2GBIII10	SO2GBII110
AS8943G-728G1TBn	Middle East	LX.PUH02.129	1G-DDR3 (64*16*8)	SO2GBIII10	SO2GBIII10	SO2GBII110
AS8943G-728G1TBn	Middle East	LX.PUH02.126	1G-DDR3 (64*16*8)	SO2GBIII10	SO2GBIII10	SO2GBII110
AS8943G-728G1TBn	Middle East	LX.PUH02.125	1G-DDR3 (64*16*8)	SO2GBIII10	SO2GBIII10	SO2GBII110
AS8943G-728G1TBn	Middle East	LX.PUH02.124	1G-DDR3 (64*16*8)	SO2GBIII10	SO2GBIII10	SO2GBII110
AS8943G-728G1TBn	Middle East	LX.PUH02.123	1G-DDR3 (64*16*8)	SO2GBIII10	SO2GBIII10	SO2GBII110
AS8943G-728G1TBn	Poland	LX.PUH02.121	1G-DDR3 (64*16*8)	SO2GBIII10	SO2GBIII10	SO2GBII110
AS8943G-728G1TBn	Portugal	LX.PUH02.099	1G-DDR3 (64*16*8)	SO2GBIII10	SO2GBIII10	SO2GBII110
AS8943G-728G1TBn	Serbia/ Macedonia	LX.PUH02.097	1G-DDR3 (64*16*8)	SO2GBIII10	SO2GBIII10	SO2GBII110
AS8943G-728G1TBn	South Africa	LX.PUH02.133	1G-DDR3 (64*16*8)	SO2GBIII10	SO2GBIII10	SO2GBII110
AS8943G-728G1TBn	South Africa	LX.PUH02.127	1G-DDR3 (64*16*8)	SO2GBIII10	SO2GBIII10	SO2GBII110
AS8943G-728G1TBn	South Africa	LX.PUH02.122	1G-DDR3 (64*16*8)	SO2GBIII10	SO2GBIII10	SO2GBII110

Model	Country	Acer P/N	VRAM 1	Memory 1	Memory 2	Memory 3
AS8943G-728G1TBn	Spain	LX.PUH02.108	1G-DDR3 (64*16*8)	SO2GBIII10	SO2GBIII10	SO2GBII110
AS8943G-728G1TBn	Spain	LX.PUG02.002	1G-DDR3 (64*16*8)	SO2GBIII10	SO2GBIII10	SO2GBII110
AS8943G-728G1TBn	Switzerland	LX.PUH02.186	1G-DDR3 (64*16*8)	SO2GBIII10	SO2GBIII10	SO2GBII110
AS8943G-728G1TBn	Switzerland	LX.PUH02.115	1G-DDR3 (64*16*8)	SO2GBIII10	SO2GBIII10	SO2GBII110
AS8943G-728G1TBn	Turkey	LX.PUH02.132	1G-DDR3 (64*16*8)	SO2GBIII10	SO2GBIII10	SO2GBII110
AS8943G-728G1TBn	UK	LX.PUH02.106	1G-DDR3 (64*16*8)	SO2GBIII10	SO2GBIII10	SO2GBII110
AS8943G-728G1TBn	Ukraine	LX.PUH02.137	1G-DDR3 (64*16*8)	SO2GBIII10	SO2GBIII10	SO2GBII110
AS8943G-728G1TMn	GCTWN	S2.PUG02.001	1G-DDR3 (64*16*8)	SO2GBIII10	SO2GBIII10	SO2GBII110
AS8943G-728G1TMn	GCTWN	S2.PUG02.001	1G-DDR3 (64*16*8)	SO2GBIII10	SO2GBIII10	SO2GBII110
AS8943G-728G1TMn	WW	S2.PUH02.001	1G-DDR3 (64*16*8)	SO2GBIII10	SO2GBIII10	SO2GBII110
AS8943G-728G1TMn	WW	S2.PUH02.001	1G-DDR3 (64*16*8)	SO2GBIII10	SO2GBIII10	SO2GBII110
AS8943G-728G1TWi	Russia	LX.PUH02.187	1G-DDR3 (64*16*8)	SO2GBIII10	SO2GBIII10	SO2GBII110
AS8943G-728G1TWn	UK	LX.PUG02.013	1G-DDR3 (64*16*8)	SO2GBIII10	SO2GBIII10	SO2GBII110
AS8943G-728G64Bi	Russia	LX.PUH02.090	1G-DDR3 (64*16*8)	SO2GBIII10	SO2GBIII10	SO2GBII110
AS8943G-728G64Bn	Algeria	LX.PUH02.082	1G-DDR3 (64*16*8)	SO2GBIII10	SO2GBIII10	SO2GBII110
AS8943G-728G64Bn	Austria	LX.PUH02.049	1G-DDR3 (64*16*8)	SO2GBIII10	SO2GBIII10	SO2GBII110
AS8943G-728G64Bn	Baltic	LX.PUH02.073	1G-DDR3 (64*16*8)	SO2GBIII10	SO2GBIII10	SO2GBII110
AS8943G-728G64Bn	Baltic	LX.PUH02.060	1G-DDR3 (64*16*8)	SO2GBIII10	SO2GBIII10	SO2GBII110
AS8943G-728G64Bn	Baltic	LX.PUH02.057	1G-DDR3 (64*16*8)	SO2GBIII10	SO2GBIII10	SO2GBII110
AS8943G-728G64Bn	Belgium	LX.PUH02.070	1G-DDR3 (64*16*8)	SO2GBIII10	SO2GBIII10	SO2GBII110
AS8943G-728G64Bn	Cyprus	LX.PUH02.059	1G-DDR3 (64*16*8)	SO2GBIII10	SO2GBIII10	SO2GBII110
AS8943G-728G64Bn	Czech	LX.PUH02.063	1G-DDR3 (64*16*8)	SO2GBIII10	SO2GBIII10	SO2GBII110
AS8943G-728G64Bn	Denmark	LX.PUH02.055	1G-DDR3 (64*16*8)	SO2GBIII10	SO2GBIII10	SO2GBII110
AS8943G-728G64Bn	Eastern Europe	LX.PUH02.066	1G-DDR3 (64*16*8)	SO2GBIII10	SO2GBIII10	SO2GBII110

Model	Country	Acer P/N	VRAM 1	Memory 1	Memory 2	Memory 3
AS8943G-728G64Bn	Eastern Europe	LX.PUH02.065	1G-DDR3 (64*16*8)	SO2GBIII10	SO2GBIII10	SO2GBII110
AS8943G-728G64Bn	Eastern Europe	LX.PUH02.054	1G-DDR3 (64*16*8)	SO2GBIII10	SO2GBIII10	SO2GBII110
AS8943G-728G64Bn	Eastern Europe	LX.PUH02.053	1G-DDR3 (64*16*8)	SO2GBIII10	SO2GBIII10	SO2GBII110
AS8943G-728G64Bn	Eastern Europe	LX.PUH02.048	1G-DDR3 (64*16*8)	SO2GBIII10	SO2GBIII10	SO2GBII110
AS8943G-728G64Bn	France	LX.PUH02.047	1G-DDR3 (64*16*8)	SO2GBIII10	SO2GBIII10	SO2GBII110
AS8943G-728G64Bn	Germany	LX.PUH02.074	1G-DDR3 (64*16*8)	SO2GBIII10	SO2GBIII10	SO2GBII110
AS8943G-728G64Bn	Greece	LX.PUH02.050	1G-DDR3 (64*16*8)	SO2GBIII10	SO2GBIII10	SO2GBII110
AS8943G-728G64Bn	Holland	LX.PUH02.071	1G-DDR3 (64*16*8)	SO2GBIII10	SO2GBIII10	SO2GBII110
AS8943G-728G64Bn	Hungary	LX.PUH02.062	1G-DDR3 (64*16*8)	SO2GBIII10	SO2GBIII10	SO2GBII110
AS8943G-728G64Bn	Israel	LX.PUH02.061	1G-DDR3 (64*16*8)	SO2GBIII10	SO2GBIII10	SO2GBII110
AS8943G-728G64Bn	Italy	LX.PUH02.052	1G-DDR3 (64*16*8)	SO2GBIII10	SO2GBIII10	SO2GBII110
AS8943G-728G64Bn	Latvia	LX.PUH02.068	1G-DDR3 (64*16*8)	SO2GBIII10	SO2GBIII10	SO2GBII110
AS8943G-728G64Bn	Latvia	LX.PUH02.067	1G-DDR3 (64*16*8)	SO2GBIII10	SO2GBIII10	SO2GBII110
AS8943G-728G64Bn	Luxembourg	LX.PUH02.072	1G-DDR3 (64*16*8)	SO2GBIII10	SO2GBIII10	SO2GBII110
AS8943G-728G64Bn	Middle East	LX.PUH02.089	1G-DDR3 (64*16*8)	SO2GBIII10	SO2GBIII10	SO2GBII110
AS8943G-728G64Bn	Middle East	LX.PUH02.088	1G-DDR3 (64*16*8)	SO2GBIII10	SO2GBIII10	SO2GBII110
AS8943G-728G64Bn	Middle East	LX.PUH02.085	1G-DDR3 (64*16*8)	SO2GBIII10	SO2GBIII10	SO2GBII110
AS8943G-728G64Bn	Middle East	LX.PUH02.084	1G-DDR3 (64*16*8)	SO2GBIII10	SO2GBIII10	SO2GBII110
AS8943G-728G64Bn	Middle East	LX.PUH02.083	1G-DDR3 (64*16*8)	SO2GBIII10	SO2GBIII10	SO2GBII110
AS8943G-728G64Bn	Middle East	LX.PUH02.080	1G-DDR3 (64*16*8)	SO2GBIII10	SO2GBIII10	SO2GBII110
AS8943G-728G64Bn	Middle East	LX.PUH02.079	1G-DDR3 (64*16*8)	SO2GBIII10	SO2GBIII10	SO2GBII110
AS8943G-728G64Bn	Middle East	LX.PUH02.078	1G-DDR3 (64*16*8)	SO2GBIII10	SO2GBIII10	SO2GBII110
AS8943G-728G64Bn	Middle East	LX.PUH02.077	1G-DDR3 (64*16*8)	SO2GBIII10	SO2GBIII10	SO2GBII110
AS8943G-728G64Bn	Poland	LX.PUH02.075	1G-DDR3 (64*16*8)	SO2GBIII10	SO2GBIII10	SO2GBII110

Model	Country	Acer P/N	VRAM 1	Memory 1	Memory 2	Memory 3
AS8943G-728G64Bn	Portugal	LX.PUH02.058	1G-DDR3 (64*16*8)	SO2GBIII10	SO2GBIII10	SO2GBII110
AS8943G-728G64Bn	Serbia/Macedonia	LX.PUH02.056	1G-DDR3 (64*16*8)	SO2GBIII10	SO2GBIII10	SO2GBII110
AS8943G-728G64Bn	South Africa	LX.PUH02.087	1G-DDR3 (64*16*8)	SO2GBIII10	SO2GBIII10	SO2GBII110
AS8943G-728G64Bn	South Africa	LX.PUH02.081	1G-DDR3 (64*16*8)	SO2GBIII10	SO2GBIII10	SO2GBII110
AS8943G-728G64Bn	South Africa	LX.PUH02.076	1G-DDR3 (64*16*8)	SO2GBIII10	SO2GBIII10	SO2GBII110
AS8943G-728G64Bn	Spain	LX.PUH02.051	1G-DDR3 (64*16*8)	SO2GBIII10	SO2GBIII10	SO2GBII110
AS8943G-728G64Bn	Switzerland	LX.PUH02.069	1G-DDR3 (64*16*8)	SO2GBIII10	SO2GBIII10	SO2GBII110
AS8943G-728G64Bn	Turkey	LX.PUH02.086	1G-DDR3 (64*16*8)	SO2GBIII10	SO2GBIII10	SO2GBII110
AS8943G-728G64Bn	UK	LX.PUH02.064	1G-DDR3 (64*16*8)	SO2GBIII10	SO2GBIII10	SO2GBII110
AS8943G-728G64Bn	Ukraine	LX.PUH02.091	1G-DDR3 (64*16*8)	SO2GBIII10	SO2GBIII10	SO2GBII110
AS8943G-82121.28T Bn	WW	S2.PWC02.007	1G-DDR3 (64*16*8)	SO2GBIII10	SO2GBIII10	SO4GBII110
AS8943G-82121.28T Bn	WW	S2.PWC02.007	1G-DDR3 (64*16*8)	SO2GBIII10	SO2GBIII10	SO4GBII110
AS8943G-82161.28T Wn	UK	LX.PWC02.075	1G-DDR3 (64*16*8)	SO4GBIII10	SO4GBIII10	SO4GBII110
AS8943G-82161.28T Wn	WW	S2.PU102.001	1G-DDR3 (64*16*8)	SO4GBIII10	SO4GBIII10	SO4GBII110
AS8943G-82161.28T Wn	WW	S2.PU102.001	1G-DDR3 (64*16*8)	SO4GBIII10	SO4GBIII10	SO4GBII110
AS8943G-828G1.28T Mn	Philippines	LX.PUH02.243	1G-DDR3 (64*16*8)	SO4GBIII10	SO4GBIII10	N

Model	Country	Acer P/N	Memory 4	HDD 1(GB)	HDD 2(GB)	ODD
AS8943G-332G57Mn	WW	S2.PTL02.001	N	N320GB5.4KS	N250GB5.4KS	NSM8XS
AS8943G-332G57Mn	WW	S2.PTL02.001	N	N320GB5.4KS	N250GB5.4KS	NSM8XS
AS8943G-333G32Mn	Turkey	LX.PUJ02.058	N	N320GB5.4KS	N	NSM8XS
AS8943G-334G50Mi	Russia	LX.PUJ02.006	N	N500GB5.4KS	N	NSM8XS

Model	Country	Acer P/N	Memory 4	HDD 1(GB)	HDD 2(GB)	ODD
AS8943G-334G50Mn	France	LX.PUJ0 2.004	N	N500GB5.4KS	N	NSM8XS
AS8943G-334G64Mn	Belgium	LX.PU20 2.005	N	N640GB5.4KS	N	NSM8XS
AS8943G-334G64Mn	Holland	LX.PU20 2.004	N	N640GB5.4KS	N	NSM8XS
AS8943G-334G64Mn	Luxembourg	LX.PU20 2.003	N	N640GB5.4KS	N	NSM8XS
AS8943G-354G50Mn	France	LX.PUJ0 2.059	N	N500GB5.4KS	N	NSM8XS
AS8943G-432G82Mn	WW	S2.PTL0 2.003	N	N500GB5.4KS	N320GB5.4KS	NSM8XS
AS8943G-432G82Mn	WW	S2.PTL0 2.003	N	N500GB5.4KS	N320GB5.4KS	NSM8XS
AS8943G-434G1TBi	Russia	LX.PUJ0 2.051	N	N500GB5.4KS	N500GB5.4KS	NBDCB4 XS
AS8943G-434G1TBn	Algeria	LX.PUJ0 2.027	N	N500GB5.4KS	N500GB5.4KS	NBDCB4 XS
AS8943G-434G1TBn	Austria	LX.PUJ0 2.009	N	N500GB5.4KS	N500GB5.4KS	NBDCB4 XS
AS8943G-434G1TBn	Baltic	LX.PUJ0 2.047	N	N500GB5.4KS	N500GB5.4KS	NBDCB4 XS
AS8943G-434G1TBn	Baltic	LX.PUJ0 2.020	N	N500GB5.4KS	N500GB5.4KS	NBDCB4 XS
AS8943G-434G1TBn	Baltic	LX.PUJ0 2.017	N	N500GB5.4KS	N500GB5.4KS	NBDCB4 XS
AS8943G-434G1TBn	Belgium	LX.PUJ0 2.045	N	N500GB5.4KS	N500GB5.4KS	NBDCB4 XS
AS8943G-434G1TBn	Cyprus	LX.PUJ0 2.018	N	N500GB5.4KS	N500GB5.4KS	NBDCB4 XS
AS8943G-434G1TBn	Czech	LX.PUJ0 2.037	N	N500GB5.4KS	N500GB5.4KS	NBDCB4 XS
AS8943G-434G1TBn	Denmark	LX.PUJ0 2.013	N	N500GB5.4KS	N500GB5.4KS	NBDCB4 XS
AS8943G-434G1TBn	Eastern Europe	LX.PUJ0 2.039	N	N500GB5.4KS	N500GB5.4KS	NBDCB4 XS
AS8943G-434G1TBn	Eastern Europe	LX.PUJ0 2.038	N	N500GB5.4KS	N500GB5.4KS	NBDCB4 XS
AS8943G-434G1TBn	Eastern Europe	LX.PUJ0 2.012	N	N500GB5.4KS	N500GB5.4KS	NBDCB4 XS
AS8943G-434G1TBn	Eastern Europe	LX.PUJ0 2.011	N	N500GB5.4KS	N500GB5.4KS	NBDCB4 XS
AS8943G-434G1TBn	Eastern Europe	LX.PUJ0 2.007	N	N500GB5.4KS	N500GB5.4KS	NBDCB4 XS
AS8943G-434G1TBn	France	LX.PUJ0 2.008	N	N500GB5.4KS	N500GB5.4KS	NBDCB4 XS
AS8943G-434G1TBn	Germany	LX.PUJ0 2.049	N	N500GB5.4KS	N500GB5.4KS	NBDCB4 XS

Model	Country	Acer P/N	Memory 4	HDD 1(GB)	HDD 2(GB)	ODD
AS8943G-434G1TBn	Greece	LX.PUJ0 2.010	N	N500GB5.4KS	N500GB5.4KS	NBDCB4 XS
AS8943G-434G1TBn	Holland	LX.PUJ0 2.046	N	N500GB5.4KS	N500GB5.4KS	NBDCB4 XS
AS8943G-434G1TBn	Hungary	LX.PUJ0 2.036	N	N500GB5.4KS	N500GB5.4KS	NBDCB4 XS
AS8943G-434G1TBn	Israel	LX.PUJ0 2.035	N	N500GB5.4KS	N500GB5.4KS	NBDCB4 XS
AS8943G-434G1TBn	Italy	LX.PUJ0 2.015	N	N500GB5.4KS	N500GB5.4KS	NBDCB4 XS
AS8943G-434G1TBn	Latvia	LX.PUJ0 2.042	N	N500GB5.4KS	N500GB5.4KS	NBDCB4 XS
AS8943G-434G1TBn	Latvia	LX.PUJ0 2.041	N	N500GB5.4KS	N500GB5.4KS	NBDCB4 XS
AS8943G-434G1TBn	Luxembourg	LX.PUJ0 2.043	N	N500GB5.4KS	N500GB5.4KS	NBDCB4 XS
AS8943G-434G1TBn	Middle East	LX.PUJ0 2.050	N	N500GB5.4KS	N500GB5.4KS	NBDCB4 XS
AS8943G-434G1TBn	Middle East	LX.PUJ0 2.034	N	N500GB5.4KS	N500GB5.4KS	NBDCB4 XS
AS8943G-434G1TBn	Middle East	LX.PUJ0 2.031	N	N500GB5.4KS	N500GB5.4KS	NBDCB4 XS
AS8943G-434G1TBn	Middle East	LX.PUJ0 2.030	N	N500GB5.4KS	N500GB5.4KS	NBDCB4 XS
AS8943G-434G1TBn	Middle East	LX.PUJ0 2.028	N	N500GB5.4KS	N500GB5.4KS	NBDCB4 XS
AS8943G-434G1TBn	Middle East	LX.PUJ0 2.025	N	N500GB5.4KS	N500GB5.4KS	NBDCB4 XS
AS8943G-434G1TBn	Middle East	LX.PUJ0 2.024	N	N500GB5.4KS	N500GB5.4KS	NBDCB4 XS
AS8943G-434G1TBn	Middle East	LX.PUJ0 2.023	N	N500GB5.4KS	N500GB5.4KS	NBDCB4 XS
AS8943G-434G1TBn	Middle East	LX.PUJ0 2.022	N	N500GB5.4KS	N500GB5.4KS	NBDCB4 XS
AS8943G-434G1TBn	Poland	LX.PUJ0 2.048	N	N500GB5.4KS	N500GB5.4KS	NBDCB4 XS
AS8943G-434G1TBn	Portugal	LX.PUJ0 2.019	N	N500GB5.4KS	N500GB5.4KS	NBDCB4 XS
AS8943G-434G1TBn	Serbia/Macedonia	LX.PUJ0 2.016	N	N500GB5.4KS	N500GB5.4KS	NBDCB4 XS
AS8943G-434G1TBn	South Africa	LX.PUJ0 2.033	N	N500GB5.4KS	N500GB5.4KS	NBDCB4 XS
AS8943G-434G1TBn	South Africa	LX.PUJ0 2.029	N	N500GB5.4KS	N500GB5.4KS	NBDCB4 XS
AS8943G-434G1TBn	South Africa	LX.PUJ0 2.026	N	N500GB5.4KS	N500GB5.4KS	NBDCB4 XS
AS8943G-434G1TBn	South Africa	LX.PUJ0 2.021	N	N500GB5.4KS	N500GB5.4KS	NBDCB4 XS

Model	Country	Acer P/N	Memory 4	HDD 1(GB)	HDD 2(GB)	ODD
AS8943G-434G1TBn	Spain	LX.PUJ0 2.014	N	N500GB5.4KS	N500GB5.4KS	NBDCB4 XS
AS8943G-434G1TBn	Switzerland	LX.PUJ0 2.044	N	N500GB5.4KS	N500GB5.4KS	NBDCB4 XS
AS8943G-434G1TBn	Turkey	LX.PUJ0 2.032	N	N500GB5.4KS	N500GB5.4KS	NBDCB4 XS
AS8943G-434G1TBn	UK	LX.PUJ0 2.040	N	N500GB5.4KS	N500GB5.4KS	NBDCB4 XS
AS8943G-434G1TBn	Ukraine	LX.PUJ0 2.052	N	N500GB5.4KS	N500GB5.4KS	NBDCB4 XS
AS8943G-434G1TMn	Belgium	LX.PUJ0 2.055	N	N500GB5.4KS	N500GB5.4KS	NSM8XS
AS8943G-434G1TMn	France	LX.PUJ0 2.003	N	N500GB5.4KS	N500GB5.4KS	NSM8XS
AS8943G-434G1TMn	Holland	LX.PUJ0 2.054	N	N500GB5.4KS	N500GB5.4KS	NSM8XS
AS8943G-434G1TMn	Luxembourg	LX.PUJ0 2.053	N	N500GB5.4KS	N500GB5.4KS	NSM8XS
AS8943G-434G32Mn	Austria	LX.PU20 2.006	N	N320GB5.4KS	N	NSM8XS
AS8943G-434G32Mn	Germany	LX.PU20 2.002	N	N320GB5.4KS	N	NSM8XS
AS8943G-434G50Bn	UK	LX.PU20 2.007	N	N500GB5.4KS	N	NBDCB4 XS
AS8943G-434G50Mn	Denmark	LX.PU10 2.092	N	N500GB5.4KS	N	NSM8XS
AS8943G-434G50Mn	Spain	LX.PUJ0 2.001	N	N500GB5.4KS	N	NSM8XS
AS8943G-434G50Mn	Turkey	LX.PUJ0 2.056	N	N500GB5.4KS	N	NSM8XS
AS8943G-434G64Bi	Russia	LX.PU10 2.099	N	N640GB5.4KS	N	NBDCB4 XS
AS8943G-434G64Bn	Czech	LX.PU10 2.103	N	N640GB5.4KS	N	NBDCB4 XS
AS8943G-434G64Mi	Russia	LX.PUJ0 2.060	N	N640GB5.4KS	N	NSM8XS
AS8943G-434G64Mi	Russia	LX.PU10 2.044	N	N640GB5.4KS	N	NSM8XS
AS8943G-434G64Mn	Algeria	LX.PU10 2.036	N	N640GB5.4KS	N	NSM8XS
AS8943G-434G64Mn	Austria	LX.PU10 2.003	N	N640GB5.4KS	N	NSM8XS
AS8943G-434G64Mn	Baltic	LX.PU10 2.022	N	N640GB5.4KS	N	NSM8XS
AS8943G-434G64Mn	Baltic	LX.PU10 2.014	N	N640GB5.4KS	N	NSM8XS
AS8943G-434G64Mn	Baltic	LX.PU10 2.011	N	N640GB5.4KS	N	NSM8XS

Model	Country	Acer P/N	Memory 4	HDD 1(GB)	HDD 2(GB)	ODD
AS8943G-434G64Mn	Belgium	LX.PU10 2.033	N	N640GB5.4KS	N	NSM8XS
AS8943G-434G64Mn	Cyprus	LX.PU10 2.013	N	N640GB5.4KS	N	NSM8XS
AS8943G-434G64Mn	Czech	LX.PU10 2.017	N	N640GB5.4KS	N	NSM8XS
AS8943G-434G64Mn	Denmark	LX.PU10 2.009	N	N640GB5.4KS	N	NSM8XS
AS8943G-434G64Mn	Eastern Europe	LX.PU10 2.020	N	N640GB5.4KS	N	NSM8XS
AS8943G-434G64Mn	Eastern Europe	LX.PU10 2.019	N	N640GB5.4KS	N	NSM8XS
AS8943G-434G64Mn	Eastern Europe	LX.PU10 2.008	N	N640GB5.4KS	N	NSM8XS
AS8943G-434G64Mn	Eastern Europe	LX.PU10 2.007	N	N640GB5.4KS	N	NSM8XS
AS8943G-434G64Mn	Eastern Europe	LX.PU10 2.002	N	N640GB5.4KS	N	NSM8XS
AS8943G-434G64Mn	France	LX.PU10 2.001	N	N640GB5.4KS	N	NSM8XS
AS8943G-434G64Mn	Germany	LX.PU10 2.023	N	N640GB5.4KS	N	NSM8XS
AS8943G-434G64Mn	Greece	LX.PU10 2.004	N	N640GB5.4KS	N	NSM8XS
AS8943G-434G64Mn	Holland	LX.PU10 2.034	N	N640GB5.4KS	N	NSM8XS
AS8943G-434G64Mn	Hungary	LX.PU10 2.016	N	N640GB5.4KS	N	NSM8XS
AS8943G-434G64Mn	Israel	LX.PU10 2.015	N	N640GB5.4KS	N	NSM8XS
AS8943G-434G64Mn	Italy	LX.PU10 2.006	N	N640GB5.4KS	N	NSM8XS
AS8943G-434G64Mn	Latvia	LX.PU10 2.031	N	N640GB5.4KS	N	NSM8XS
AS8943G-434G64Mn	Latvia	LX.PU10 2.021	N	N640GB5.4KS	N	NSM8XS
AS8943G-434G64Mn	Luxembourg	LX.PU10 2.035	N	N640GB5.4KS	N	NSM8XS
AS8943G-434G64Mn	Middle East	LX.PU10 2.043	N	N640GB5.4KS	N	NSM8XS
AS8943G-434G64Mn	Middle East	LX.PU10 2.042	N	N640GB5.4KS	N	NSM8XS
AS8943G-434G64Mn	Middle East	LX.PU10 2.039	N	N640GB5.4KS	N	NSM8XS
AS8943G-434G64Mn	Middle East	LX.PU10 2.038	N	N640GB5.4KS	N	NSM8XS
AS8943G-434G64Mn	Middle East	LX.PU10 2.037	N	N640GB5.4KS	N	NSM8XS

Model	Country	Acer P/N	Memory 4	HDD 1(GB)	HDD 2(GB)	ODD
AS8943G-434G64Mn	Middle East	LX.PU10 2.029	N	N640GB5.4KS	N	NSM8XS
AS8943G-434G64Mn	Middle East	LX.PU10 2.028	N	N640GB5.4KS	N	NSM8XS
AS8943G-434G64Mn	Middle East	LX.PU10 2.027	N	N640GB5.4KS	N	NSM8XS
AS8943G-434G64Mn	Middle East	LX.PU10 2.026	N	N640GB5.4KS	N	NSM8XS
AS8943G-434G64Mn	Poland	LX.PU10 2.024	N	N640GB5.4KS	N	NSM8XS
AS8943G-434G64Mn	Portugal	LX.PU10 2.012	N	N640GB5.4KS	N	NSM8XS
AS8943G-434G64Mn	Serbia/ Macedonia	LX.PU10 2.010	N	N640GB5.4KS	N	NSM8XS
AS8943G-434G64Mn	South Africa	LX.PU10 2.041	N	N640GB5.4KS	N	NSM8XS
AS8943G-434G64Mn	South Africa	LX.PU10 2.030	N	N640GB5.4KS	N	NSM8XS
AS8943G-434G64Mn	South Africa	LX.PU10 2.025	N	N640GB5.4KS	N	NSM8XS
AS8943G-434G64Mn	Spain	LX.PUJ0 2.002	N	N640GB5.4KS	N	NSM8XS
AS8943G-434G64Mn	Spain	LX.PU10 2.005	N	N640GB5.4KS	N	NSM8XS
AS8943G-434G64Mn	Switzerland	LX.PU10 2.032	N	N640GB5.4KS	N	NSM8XS
AS8943G-434G64Mn	Turkey	LX.PU10 2.097	N	N640GB5.4KS	N	NSM8XS
AS8943G-434G64Mn	Turkey	LX.PU10 2.040	N	N640GB5.4KS	N	NSM8XS
AS8943G-434G64Mn	UK	LX.PU10 2.018	N	N640GB5.4KS	N	NSM8XS
AS8943G-434G64Mn	Ukraine	LX.PU10 2.045	N	N640GB5.4KS	N	NSM8XS
AS8943G-436G1TBi	Russia	LX.PU10 2.089	N	N500GB5.4KS	N500GB5.4KS	NBDCB4 XS
AS8943G-436G1TBn	Algeria	LX.PU10 2.081	N	N500GB5.4KS	N500GB5.4KS	NBDCB4 XS
AS8943G-436G1TBn	Austria	LX.PU10 2.048	N	N500GB5.4KS	N500GB5.4KS	NBDCB4 XS
AS8943G-436G1TBn	Baltic	LX.PU10 2.072	N	N500GB5.4KS	N500GB5.4KS	NBDCB4 XS
AS8943G-436G1TBn	Baltic	LX.PU10 2.059	N	N500GB5.4KS	N500GB5.4KS	NBDCB4 XS
AS8943G-436G1TBn	Baltic	LX.PU10 2.056	N	N500GB5.4KS	N500GB5.4KS	NBDCB4 XS
AS8943G-436G1TBn	Belgium	LX.PU10 2.069	N	N500GB5.4KS	N500GB5.4KS	NBDCB4 XS

Model	Country	Acer P/N	Memory 4	HDD 1(GB)	HDD 2(GB)	ODD
AS8943G-436G1TBn	Cyprus	LX.PU10 2.058	N	N500GB5.4KS	N500GB5.4KS	NBDCB4 XS
AS8943G-436G1TBn	Czech	LX.PU10 2.062	N	N500GB5.4KS	N500GB5.4KS	NBDCB4 XS
AS8943G-436G1TBn	Denmark	LX.PU10 2.054	N	N500GB5.4KS	N500GB5.4KS	NBDCB4 XS
AS8943G-436G1TBn	Eastern Europe	LX.PU10 2.065	N	N500GB5.4KS	N500GB5.4KS	NBDCB4 XS
AS8943G-436G1TBn	Eastern Europe	LX.PU10 2.064	N	N500GB5.4KS	N500GB5.4KS	NBDCB4 XS
AS8943G-436G1TBn	Eastern Europe	LX.PU10 2.053	N	N500GB5.4KS	N500GB5.4KS	NBDCB4 XS
AS8943G-436G1TBn	Eastern Europe	LX.PU10 2.052	N	N500GB5.4KS	N500GB5.4KS	NBDCB4 XS
AS8943G-436G1TBn	Eastern Europe	LX.PU10 2.047	N	N500GB5.4KS	N500GB5.4KS	NBDCB4 XS
AS8943G-436G1TBn	France	LX.PU10 2.046	N	N500GB5.4KS	N500GB5.4KS	NBDCB4 XS
AS8943G-436G1TBn	Germany	LX.PU10 2.073	N	N500GB5.4KS	N500GB5.4KS	NBDCB4 XS
AS8943G-436G1TBn	Greece	LX.PU10 2.049	N	N500GB5.4KS	N500GB5.4KS	NBDCB4 XS
AS8943G-436G1TBn	Holland	LX.PU10 2.070	N	N500GB5.4KS	N500GB5.4KS	NBDCB4 XS
AS8943G-436G1TBn	Hungary	LX.PU10 2.061	N	N500GB5.4KS	N500GB5.4KS	NBDCB4 XS
AS8943G-436G1TBn	Israel	LX.PU10 2.060	N	N500GB5.4KS	N500GB5.4KS	NBDCB4 XS
AS8943G-436G1TBn	Italy	LX.PU10 2.051	N	N500GB5.4KS	N500GB5.4KS	NBDCB4 XS
AS8943G-436G1TBn	Latvia	LX.PU10 2.067	N	N500GB5.4KS	N500GB5.4KS	NBDCB4 XS
AS8943G-436G1TBn	Latvia	LX.PU10 2.066	N	N500GB5.4KS	N500GB5.4KS	NBDCB4 XS
AS8943G-436G1TBn	Luxembourg	LX.PU10 2.071	N	N500GB5.4KS	N500GB5.4KS	NBDCB4 XS
AS8943G-436G1TBn	Middle East	LX.PU10 2.088	N	N500GB5.4KS	N500GB5.4KS	NBDCB4 XS
AS8943G-436G1TBn	Middle East	LX.PU10 2.087	N	N500GB5.4KS	N500GB5.4KS	NBDCB4 XS
AS8943G-436G1TBn	Middle East	LX.PU10 2.084	N	N500GB5.4KS	N500GB5.4KS	NBDCB4 XS
AS8943G-436G1TBn	Middle East	LX.PU10 2.083	N	N500GB5.4KS	N500GB5.4KS	NBDCB4 XS
AS8943G-436G1TBn	Middle East	LX.PU10 2.082	N	N500GB5.4KS	N500GB5.4KS	NBDCB4 XS
AS8943G-436G1TBn	Middle East	LX.PU10 2.079	N	N500GB5.4KS	N500GB5.4KS	NBDCB4 XS

Model	Country	Acer P/N	Memory 4	HDD 1(GB)	HDD 2(GB)	ODD
AS8943G-436G1TBn	Middle East	LX.PU10 2.078	N	N500GB5.4KS	N500GB5.4KS	NBDCB4 XS
AS8943G-436G1TBn	Middle East	LX.PU10 2.077	N	N500GB5.4KS	N500GB5.4KS	NBDCB4 XS
AS8943G-436G1TBn	Middle East	LX.PU10 2.076	N	N500GB5.4KS	N500GB5.4KS	NBDCB4 XS
AS8943G-436G1TBn	Poland	LX.PU10 2.074	N	N500GB5.4KS	N500GB5.4KS	NBDCB4 XS
AS8943G-436G1TBn	Portugal	LX.PU10 2.057	N	N500GB5.4KS	N500GB5.4KS	NBDCB4 XS
AS8943G-436G1TBn	Serbia/Macedonia	LX.PU10 2.055	N	N500GB5.4KS	N500GB5.4KS	NBDCB4 XS
AS8943G-436G1TBn	South Africa	LX.PU10 2.086	N	N500GB5.4KS	N500GB5.4KS	NBDCB4 XS
AS8943G-436G1TBn	South Africa	LX.PU10 2.080	N	N500GB5.4KS	N500GB5.4KS	NBDCB4 XS
AS8943G-436G1TBn	South Africa	LX.PU10 2.075	N	N500GB5.4KS	N500GB5.4KS	NBDCB4 XS
AS8943G-436G1TBn	Spain	LX.PU10 2.050	N	N500GB5.4KS	N500GB5.4KS	NBDCB4 XS
AS8943G-436G1TBn	Switzerland	LX.PU10 2.068	N	N500GB5.4KS	N500GB5.4KS	NBDCB4 XS
AS8943G-436G1TBn	Turkey	LX.PU10 2.085	N	N500GB5.4KS	N500GB5.4KS	NBDCB4 XS
AS8943G-436G1TBn	UK	LX.PU10 2.063	N	N500GB5.4KS	N500GB5.4KS	NBDCB4 XS
AS8943G-436G1TBn	Ukraine	LX.PU10 2.090	N	N500GB5.4KS	N500GB5.4KS	NBDCB4 XS
AS8943G-436G1TWn	Turkey	LX.PU10 2.098	N	N500GB5.4KS	N500GB5.4KS	NBDRW4 XS
AS8943G-438G1TBn	Switzerland	LX.PU10 2.096	N	N500GB5.4KS	N500GB5.4KS	NBDCB4 XS
AS8943G-438G64Bn	Switzerland	LX.PU10 2.095	N	N640GB5.4KS	N	NBDCB4 XS
AS8943G-524G64Mn	WW	S2.PTL0 2.002	N	N320GB5.4KS	N320GB5.4KS	NSM8XS
AS8943G-524G64Mn	WW	S2.PTL0 2.002	N	N320GB5.4KS	N320GB5.4KS	NSM8XS
AS8943G-524G64Mn	WW	S2.PTJ0 2.002	N	N320GB5.4KS	N320GB5.4KS	NSM8XS
AS8943G-524G64Mn	WW	S2.PTJ0 2.002	N	N320GB5.4KS	N320GB5.4KS	NSM8XS
AS8943G-526G1TWn	Turkey	LX.PU10 2.102	N	N500GB5.4KS	N500GB5.4KS	NBDRW4 XS
AS8943G-526G64Mn	Turkey	LX.PUJ0 2.057	N	N320GB5.4KS	N320GB5.4KS	NSM8XS
AS8943G-544G1TMn	WW	S2.PUJ0 2.001	N	N500GB5.4KS	N500GB5.4KS	NSM8XS

Model	Country	Acer P/N	Memory 4	HDD 1(GB)	HDD 2(GB)	ODD
AS8943G-544G1TMn	WW	S2.PUJ0 2.001	N	N500GB5.4KS	N500GB5.4KS	NSM8XS
AS8943G-544G64Bn	WW	S2.PTJ0 2.001	N	N320GB5.4KS	N320GB5.4KS	NBDCB4 XS
AS8943G-544G64Bn	WW	S2.PTJ0 2.001	N	N320GB5.4KS	N320GB5.4KS	NBDCB4 XS
AS8943G-624G1.28T Bn	France	LX.PU10 2.093	N	N640GB5.4KS	N640GB5.4KS	NBDCB4 XS
AS8943G-624G1TMn	France	LX.PU10 2.094	N	N500GB5.4KS	N500GB5.4KS	NSM8XS
AS8943G-624G64Mn	China	LX.PU20 2.001	N	N640GB5.4KS	N	NSM8XS
AS8943G-624G64Mn	Hong Kong	LX.PU10 2.091	N	N640GB5.4KS	N	NSM8XS
AS8943G-626G1TWn	Turkey	LX.PUJ0 2.005	N	N500GB5.4KS	N500GB5.4KS	NBDRW4 XS
AS8943G-626G1TWn	Turkey	LX.PU10 2.101	N	N500GB5.4KS	N500GB5.4KS	NBDRW4 XS
AS8943G-628G1TMn	WW	S2.PU20 2.001	N	N500GB5.4KS	N500GB5.4KS	NSM8XS
AS8943G-628G1TMn	WW	S2.PU20 2.001	N	N500GB5.4KS	N500GB5.4KS	NSM8XS
AS8943G-72101.28T Wn	Singapore	LX.PUH0 2.236	N	N640GB5.4KS	N640GB5.4KS	NBDRW4 XS
AS8943G-72101.28T Wn	Singapore	LX.PUG0 2.010	N	N640GB5.4KS	N640GB5.4KS	NBDRW4 XS
AS8943G-72161.28T Wn	Belgium	LX.PUH0 2.246	SO4GBII I10	N640GB5.4KS	N640GB5.4KS	NBDRW4 XS
AS8943G-72161.28T Wn	Germany	LX.PUH0 2.188	SO4GBII I10	N640GB5.4KS	N640GB5.4KS	NBDRW4 XS
AS8943G-72161.28T Wn	Holland	LX.PUH0 2.245	SO4GBII I10	N640GB5.4KS	N640GB5.4KS	NBDRW4 XS
AS8943G-72161.28T Wn	Luxembourg	LX.PUH0 2.244	SO4GBII I10	N640GB5.4KS	N640GB5.4KS	NBDRW4 XS
AS8943G-72161.28T Wn	Singapore	LX.PUH0 2.190	SO4GBII I10	N640GB5.4KS	N640GB5.4KS	NBDRW4 XS
AS8943G-72161.28T Wn	Singapore	LX.PUG0 2.009	SO4GBII I10	N640GB5.4KS	N640GB5.4KS	NBDRW4 XS
AS8943G-72161.28T Wn	Spain	LX.PUG0 2.003	SO4GBII I10	N640GB5.4KS	N640GB5.4KS	NBDRW4 XS

Model	Country	Acer P/N	Memory 4	HDD 1(GB)	HDD 2(GB)	ODD
AS8943G-72161.28T Wn	UK	LX.PUG0 2.014	SO4GBII I10	N640GB5.4KS	N640GB5.4KS	NBDRW4 XS
AS8943G-721632Wn	Poland	LX.PUH0 2.255	SO4GBII I10	N320GB5.4KS	N	NBDRW4 XS
AS8943G-721682Bn	WW	S2.PUG0 2.002	SO4GBII I10	N500GB5.4KS	N320GB5.4KS	NBDCB4 XS
AS8943G-721682Bn	WW	S2.PUG0 2.002	SO4GBII I10	N500GB5.4KS	N320GB5.4KS	NBDCB4 XS
AS8943G-724G1TBn	Belgium	LX.PUH0 2.249	N	N500GB5.4KS	N500GB5.4KS	NBDCB4 XS
AS8943G-724G1TBn	GCTWN	LX.PUH0 2.183	N	N500GB5.4KS	N500GB5.4KS	NBDCB4 XS
AS8943G-724G1TBn	GCTWN	LX.PUH0 2.182	N	N500GB5.4KS	N500GB5.4KS	NBDCB4 XS
AS8943G-724G1TBn	Germany	LX.PUH0 2.239	N	N500GB5.4KS	N500GB5.4KS	NBDCB4 XS
AS8943G-724G1TBn	Holland	LX.PUH0 2.248	N	N500GB5.4KS	N500GB5.4KS	NBDCB4 XS
AS8943G-724G1TBn	Hong Kong	LX.PUH0 2.181	N	N500GB5.4KS	N500GB5.4KS	NBDCB4 XS
AS8943G-724G1TBn	Luxembourg	LX.PUH0 2.247	N	N500GB5.4KS	N500GB5.4KS	NBDCB4 XS
AS8943G-724G1TMn	Algeria	LX.PUH0 2.226	N	N500GB5.4KS	N500GB5.4KS	NSM8XS
AS8943G-724G1TMn	Austria	LX.PUH0 2.193	N	N500GB5.4KS	N500GB5.4KS	NSM8XS
AS8943G-724G1TMn	Baltic	LX.PUH0 2.218	N	N500GB5.4KS	N500GB5.4KS	NSM8XS
AS8943G-724G1TMn	Baltic	LX.PUH0 2.205	N	N500GB5.4KS	N500GB5.4KS	NSM8XS
AS8943G-724G1TMn	Baltic	LX.PUH0 2.202	N	N500GB5.4KS	N500GB5.4KS	NSM8XS
AS8943G-724G1TMn	Belgium	LX.PUH0 2.216	N	N500GB5.4KS	N500GB5.4KS	NSM8XS
AS8943G-724G1TMn	Cyprus	LX.PUH0 2.203	N	N500GB5.4KS	N500GB5.4KS	NSM8XS
AS8943G-724G1TMn	Czech	LX.PUH0 2.208	N	N500GB5.4KS	N500GB5.4KS	NSM8XS
AS8943G-724G1TMn	Denmark	LX.PUH0 2.197	N	N500GB5.4KS	N500GB5.4KS	NSM8XS
AS8943G-724G1TMn	Eastern Europe	LX.PUH0 2.210	N	N500GB5.4KS	N500GB5.4KS	NSM8XS
AS8943G-724G1TMn	Eastern Europe	LX.PUH0 2.209	N	N500GB5.4KS	N500GB5.4KS	NSM8XS
AS8943G-724G1TMn	Eastern Europe	LX.PUH0 2.196	N	N500GB5.4KS	N500GB5.4KS	NSM8XS
AS8943G-724G1TMn	Eastern Europe	LX.PUH0 2.195	N	N500GB5.4KS	N500GB5.4KS	NSM8XS

Model	Country	Acer P/N	Memory 4	HDD 1(GB)	HDD 2(GB)	ODD
AS8943G-724G1TMn	Eastern Europe	LX.PUH0 2.191	N	N500GB5.4KS	N500GB5.4KS	NSM8XS
AS8943G-724G1TMn	France	LX.PUH0 2.192	N	N500GB5.4KS	N500GB5.4KS	NSM8XS
AS8943G-724G1TMn	Germany	LX.PUH0 2.220	N	N500GB5.4KS	N500GB5.4KS	NSM8XS
AS8943G-724G1TMn	Greece	LX.PUH0 2.194	N	N500GB5.4KS	N500GB5.4KS	NSM8XS
AS8943G-724G1TMn	Holland	LX.PUH0 2.217	N	N500GB5.4KS	N500GB5.4KS	NSM8XS
AS8943G-724G1TMn	Hungary	LX.PUH0 2.207	N	N500GB5.4KS	N500GB5.4KS	NSM8XS
AS8943G-724G1TMn	Israel	LX.PUH0 2.206	N	N500GB5.4KS	N500GB5.4KS	NSM8XS
AS8943G-724G1TMn	Italy	LX.PUH0 2.199	N	N500GB5.4KS	N500GB5.4KS	NSM8XS
AS8943G-724G1TMn	Latvia	LX.PUH0 2.213	N	N500GB5.4KS	N500GB5.4KS	NSM8XS
AS8943G-724G1TMn	Latvia	LX.PUH0 2.212	N	N500GB5.4KS	N500GB5.4KS	NSM8XS
AS8943G-724G1TMn	Luxembourg	LX.PUH0 2.214	N	N500GB5.4KS	N500GB5.4KS	NSM8XS
AS8943G-724G1TMn	Middle East	LX.PUH0 2.235	N	N500GB5.4KS	N500GB5.4KS	NSM8XS
AS8943G-724G1TMn	Middle East	LX.PUH0 2.234	N	N500GB5.4KS	N500GB5.4KS	NSM8XS
AS8943G-724G1TMn	Middle East	LX.PUH0 2.231	N	N500GB5.4KS	N500GB5.4KS	NSM8XS
AS8943G-724G1TMn	Middle East	LX.PUH0 2.230	N	N500GB5.4KS	N500GB5.4KS	NSM8XS
AS8943G-724G1TMn	Middle East	LX.PUH0 2.228	N	N500GB5.4KS	N500GB5.4KS	NSM8XS
AS8943G-724G1TMn	Middle East	LX.PUH0 2.227	N	N500GB5.4KS	N500GB5.4KS	NSM8XS
AS8943G-724G1TMn	Middle East	LX.PUH0 2.224	N	N500GB5.4KS	N500GB5.4KS	NSM8XS
AS8943G-724G1TMn	Middle East	LX.PUH0 2.223	N	N500GB5.4KS	N500GB5.4KS	NSM8XS
AS8943G-724G1TMn	Middle East	LX.PUH0 2.222	N	N500GB5.4KS	N500GB5.4KS	NSM8XS
AS8943G-724G1TMn	Poland	LX.PUH0 2.219	N	N500GB5.4KS	N500GB5.4KS	NSM8XS
AS8943G-724G1TMn	Portugal	LX.PUH0 2.204	N	N500GB5.4KS	N500GB5.4KS	NSM8XS
AS8943G-724G1TMn	Serbia/Macedonia	LX.PUH0 2.201	N	N500GB5.4KS	N500GB5.4KS	NSM8XS
AS8943G-724G1TMn	South Africa	LX.PUH0 2.233	N	N500GB5.4KS	N500GB5.4KS	NSM8XS

Model	Country	Acer P/N	Memory 4	HDD 1(GB)	HDD 2(GB)	ODD
AS8943G-724G1TMn	South Africa	LX.PUH0 2.229	N	N500GB5.4KS	N500GB5.4KS	NSM8XS
AS8943G-724G1TMn	South Africa	LX.PUH0 2.225	N	N500GB5.4KS	N500GB5.4KS	NSM8XS
AS8943G-724G1TMn	South Africa	LX.PUH0 2.221	N	N500GB5.4KS	N500GB5.4KS	NSM8XS
AS8943G-724G1TMn	Spain	LX.PUH0 2.198	N	N500GB5.4KS	N500GB5.4KS	NSM8XS
AS8943G-724G1TMn	Switzerland	LX.PUH0 2.215	N	N500GB5.4KS	N500GB5.4KS	NSM8XS
AS8943G-724G1TMn	Turkey	LX.PUH0 2.232	N	N500GB5.4KS	N500GB5.4KS	NSM8XS
AS8943G-724G1TMn	UK	LX.PUH0 2.211	N	N500GB5.4KS	N500GB5.4KS	NSM8XS
AS8943G-724G1TWn	Hong Kong	LX.PUH0 2.238	N	N500GB5.4KS	N500GB5.4KS	NBDRW4 XS
AS8943G-724G50Bn	USA	LX.PWC 02.074	N	N500GB5.4KS	N	NBDCB4 XS
AS8943G-724G50Mn	USA	LX.PWC 02.070	N	N500GB5.4KS	N	NSM8XS
AS8943G-724G64Bn	Middle East	LX.PWC 02.069	N	N640GB5.4KS	N	NBDCB4 XS
AS8943G-724G64Bn	UK	LX.PWC 02.076	N	N640GB5.4KS	N	NBDCB4 XS
AS8943G-724G64Mi	Russia	LX.PWC 02.066	N	N640GB5.4KS	N	NSM8XS
AS8943G-724G64Mi	Russia	LX.PUH0 2.045	N	N640GB5.4KS	N	NSM8XS
AS8943G-724G64Mn	Algeria	LX.PWC 02.047	N	N640GB5.4KS	N	NSM8XS
AS8943G-724G64Mn	Algeria	LX.PUH0 2.037	N	N640GB5.4KS	N	NSM8XS
AS8943G-724G64Mn	Austria	LX.PWC 02.005	N	N640GB5.4KS	N	NSM8XS
AS8943G-724G64Mn	Austria	LX.PUH0 2.009	N	N640GB5.4KS	N	NSM8XS
AS8943G-724G64Mn	Baltic	LX.PWC 02.058	N	N640GB5.4KS	N	NSM8XS
AS8943G-724G64Mn	Baltic	LX.PWC 02.027	N	N640GB5.4KS	N	NSM8XS
AS8943G-724G64Mn	Baltic	LX.PWC 02.024	N	N640GB5.4KS	N	NSM8XS
AS8943G-724G64Mn	Baltic	LX.PUH0 2.028	N	N640GB5.4KS	N	NSM8XS
AS8943G-724G64Mn	Baltic	LX.PUH0 2.020	N	N640GB5.4KS	N	NSM8XS
AS8943G-724G64Mn	Baltic	LX.PUH0 2.017	N	N640GB5.4KS	N	NSM8XS

Model	Country	Acer P/N	Memory 4	HDD 1(GB)	HDD 2(GB)	ODD
AS8943G-724G64Mn	Belgium	LX.PWC 02.055	N	N640GB5.4KS	N	NSM8XS
AS8943G-724G64Mn	Belgium	LX.PUH0 2.025	N	N640GB5.4KS	N	NSM8XS
AS8943G-724G64Mn	China	LX.PUH0 2.001	N	N640GB5.4KS	N	NSM8XS
AS8943G-724G64Mn	Cyprus	LX.PWC 02.025	N	N640GB5.4KS	N	NSM8XS
AS8943G-724G64Mn	Cyprus	LX.PUH0 2.019	N	N640GB5.4KS	N	NSM8XS
AS8943G-724G64Mn	Czech	LX.PWC 02.030	N	N640GB5.4KS	N	NSM8XS
AS8943G-724G64Mn	Czech	LX.PUH0 2.004	N	N640GB5.4KS	N	NSM8XS
AS8943G-724G64Mn	Denmark	LX.PWC 02.012	N	N640GB5.4KS	N	NSM8XS
AS8943G-724G64Mn	Denmark	LX.PUH0 2.015	N	N640GB5.4KS	N	NSM8XS
AS8943G-724G64Mn	Eastern Europe	LX.PWC 02.040	N	N640GB5.4KS	N	NSM8XS
AS8943G-724G64Mn	Eastern Europe	LX.PWC 02.037	N	N640GB5.4KS	N	NSM8XS
AS8943G-724G64Mn	Eastern Europe	LX.PWC 02.011	N	N640GB5.4KS	N	NSM8XS
AS8943G-724G64Mn	Eastern Europe	LX.PWC 02.008	N	N640GB5.4KS	N	NSM8XS
AS8943G-724G64Mn	Eastern Europe	LX.PWC 02.001	N	N640GB5.4KS	N	NSM8XS
AS8943G-724G64Mn	Eastern Europe	LX.PUH0 2.021	N	N640GB5.4KS	N	NSM8XS
AS8943G-724G64Mn	Eastern Europe	LX.PUH0 2.014	N	N640GB5.4KS	N	NSM8XS
AS8943G-724G64Mn	Eastern Europe	LX.PUH0 2.013	N	N640GB5.4KS	N	NSM8XS
AS8943G-724G64Mn	Eastern Europe	LX.PUH0 2.008	N	N640GB5.4KS	N	NSM8XS
AS8943G-724G64Mn	Eastern Europe	LX.PUH0 2.006	N	N640GB5.4KS	N	NSM8XS
AS8943G-724G64Mn	France	LX.PWC 02.004	N	N640GB5.4KS	N	NSM8XS
AS8943G-724G64Mn	France	LX.PUH0 2.007	N	N640GB5.4KS	N	NSM8XS
AS8943G-724G64Mn	Germany	LX.PWC 02.061	N	N640GB5.4KS	N	NSM8XS
AS8943G-724G64Mn	Germany	LX.PUH0 2.029	N	N640GB5.4KS	N	NSM8XS
AS8943G-724G64Mn	Greece	LX.PWC 02.007	N	N640GB5.4KS	N	NSM8XS

Model	Country	Acer P/N	Memory 4	HDD 1(GB)	HDD 2(GB)	ODD
AS8943G-724G64Mn	Greece	LX.PUH0 2.010	N	N640GB5.4KS	N	NSM8XS
AS8943G-724G64Mn	Holland	LX.PWC 02.056	N	N640GB5.4KS	N	NSM8XS
AS8943G-724G64Mn	Holland	LX.PUH0 2.026	N	N640GB5.4KS	N	NSM8XS
AS8943G-724G64Mn	Hungary	LX.PWC 02.029	N	N640GB5.4KS	N	NSM8XS
AS8943G-724G64Mn	Hungary	LX.PUH0 2.003	N	N640GB5.4KS	N	NSM8XS
AS8943G-724G64Mn	Israel	LX.PWC 02.028	N	N640GB5.4KS	N	NSM8XS
AS8943G-724G64Mn	Israel	LX.PUH0 2.002	N	N640GB5.4KS	N	NSM8XS
AS8943G-724G64Mn	Italy	LX.PWC 02.018	N	N640GB5.4KS	N	NSM8XS
AS8943G-724G64Mn	Italy	LX.PUH0 2.012	N	N640GB5.4KS	N	NSM8XS
AS8943G-724G64Mn	Latvia	LX.PWC 02.043	N	N640GB5.4KS	N	NSM8XS
AS8943G-724G64Mn	Latvia	LX.PWC 02.042	N	N640GB5.4KS	N	NSM8XS
AS8943G-724G64Mn	Latvia	LX.PUH0 2.023	N	N640GB5.4KS	N	NSM8XS
AS8943G-724G64Mn	Latvia	LX.PUH0 2.022	N	N640GB5.4KS	N	NSM8XS
AS8943G-724G64Mn	Luxembourg	LX.PWC 02.044	N	N640GB5.4KS	N	NSM8XS
AS8943G-724G64Mn	Luxembourg	LX.PUH0 2.027	N	N640GB5.4KS	N	NSM8XS
AS8943G-724G64Mn	Middle East	LX.PWC 02.065	N	N640GB5.4KS	N	NSM8XS
AS8943G-724G64Mn	Middle East	LX.PWC 02.064	N	N640GB5.4KS	N	NSM8XS
AS8943G-724G64Mn	Middle East	LX.PWC 02.051	N	N640GB5.4KS	N	NSM8XS
AS8943G-724G64Mn	Middle East	LX.PWC 02.050	N	N640GB5.4KS	N	NSM8XS
AS8943G-724G64Mn	Middle East	LX.PWC 02.048	N	N640GB5.4KS	N	NSM8XS
AS8943G-724G64Mn	Middle East	LX.PWC 02.035	N	N640GB5.4KS	N	NSM8XS
AS8943G-724G64Mn	Middle East	LX.PWC 02.034	N	N640GB5.4KS	N	NSM8XS
AS8943G-724G64Mn	Middle East	LX.PWC 02.033	N	N640GB5.4KS	N	NSM8XS
AS8943G-724G64Mn	Middle East	LX.PWC 02.032	N	N640GB5.4KS	N	NSM8XS

Model	Country	Acer P/N	Memory 4	HDD 1(GB)	HDD 2(GB)	ODD
AS8943G-724G64Mn	Middle East	LX.PUH0 2.044	N	N640GB5.4KS	N	NSM8XS
AS8943G-724G64Mn	Middle East	LX.PUH0 2.043	N	N640GB5.4KS	N	NSM8XS
AS8943G-724G64Mn	Middle East	LX.PUH0 2.040	N	N640GB5.4KS	N	NSM8XS
AS8943G-724G64Mn	Middle East	LX.PUH0 2.039	N	N640GB5.4KS	N	NSM8XS
AS8943G-724G64Mn	Middle East	LX.PUH0 2.038	N	N640GB5.4KS	N	NSM8XS
AS8943G-724G64Mn	Middle East	LX.PUH0 2.035	N	N640GB5.4KS	N	NSM8XS
AS8943G-724G64Mn	Middle East	LX.PUH0 2.034	N	N640GB5.4KS	N	NSM8XS
AS8943G-724G64Mn	Middle East	LX.PUH0 2.033	N	N640GB5.4KS	N	NSM8XS
AS8943G-724G64Mn	Middle East	LX.PUH0 2.032	N	N640GB5.4KS	N	NSM8XS
AS8943G-724G64Mn	Poland	LX.PWC 02.059	N	N640GB5.4KS	N	NSM8XS
AS8943G-724G64Mn	Poland	LX.PUH0 2.030	N	N640GB5.4KS	N	NSM8XS
AS8943G-724G64Mn	Portugal	LX.PWC 02.026	N	N640GB5.4KS	N	NSM8XS
AS8943G-724G64Mn	Portugal	LX.PUH0 2.018	N	N640GB5.4KS	N	NSM8XS
AS8943G-724G64Mn	Serbia/ Macedonia	LX.PWC 02.019	N	N640GB5.4KS	N	NSM8XS
AS8943G-724G64Mn	Serbia/ Macedonia	LX.PUH0 2.016	N	N640GB5.4KS	N	NSM8XS
AS8943G-724G64Mn	South Africa	LX.PWC 02.063	N	N640GB5.4KS	N	NSM8XS
AS8943G-724G64Mn	South Africa	LX.PWC 02.049	N	N640GB5.4KS	N	NSM8XS
AS8943G-724G64Mn	South Africa	LX.PWC 02.046	N	N640GB5.4KS	N	NSM8XS
AS8943G-724G64Mn	South Africa	LX.PWC 02.031	N	N640GB5.4KS	N	NSM8XS
AS8943G-724G64Mn	South Africa	LX.PUH0 2.042	N	N640GB5.4KS	N	NSM8XS
AS8943G-724G64Mn	South Africa	LX.PUH0 2.036	N	N640GB5.4KS	N	NSM8XS
AS8943G-724G64Mn	South Africa	LX.PUH0 2.031	N	N640GB5.4KS	N	NSM8XS
AS8943G-724G64Mn	Spain	LX.PWC 02.015	N	N640GB5.4KS	N	NSM8XS
AS8943G-724G64Mn	Spain	LX.PUH0 2.011	N	N640GB5.4KS	N	NSM8XS

Model	Country	Acer P/N	Memory 4	HDD 1(GB)	HDD 2(GB)	ODD
AS8943G-724G64Mn	Switzerland	LX.PWC 02.045	N	N640GB5.4KS	N	NSM8XS
AS8943G-724G64Mn	Switzerland	LX.PUH0 2.024	N	N640GB5.4KS	N	NSM8XS
AS8943G-724G64Mn	Turkey	LX.PWC 02.062	N	N640GB5.4KS	N	NSM8XS
AS8943G-724G64Mn	Turkey	LX.PUH0 2.041	N	N640GB5.4KS	N	NSM8XS
AS8943G-724G64Mn	UK	LX.PWC 02.041	N	N640GB5.4KS	N	NSM8XS
AS8943G-724G64Mn	UK	LX.PUH0 2.005	N	N640GB5.4KS	N	NSM8XS
AS8943G-724G64Mn	Ukraine	LX.PWC 02.067	N	N640GB5.4KS	N	NSM8XS
AS8943G-724G64Mn	Ukraine	LX.PUH0 2.046	N	N640GB5.4KS	N	NSM8XS
AS8943G-724G64Wn	China	LX.PUH0 2.237	N	N640GB5.4KS	N	NBDRW4 XS
AS8943G-724G64Wn	Middle East	LX.PWC 02.068	N	N640GB5.4KS	N	NBDRW4 XS
AS8943G-726G1.28T Bn	Belgium	LX.PWC 02.071	N	N640GB5.4KS	N640GB5.4KS	NBDCB4 XS
AS8943G-726G1.28T Bn	Belgium	LX.PUH0 2.241	N	N640GB5.4KS	N640GB5.4KS	NBDCB4 XS
AS8943G-726G1.28T Bn	Holland	LX.PWC 02.073	N	N640GB5.4KS	N640GB5.4KS	NBDCB4 XS
AS8943G-726G1.28T Bn	Holland	LX.PUH0 2.240	N	N640GB5.4KS	N640GB5.4KS	NBDCB4 XS
AS8943G-726G1.28T Bn	Luxembourg	LX.PWC 02.072	N	N640GB5.4KS	N640GB5.4KS	NBDCB4 XS
AS8943G-726G1.28T Bn	Luxembourg	LX.PUH0 2.242	N	N640GB5.4KS	N640GB5.4KS	NBDCB4 XS
AS8943G-726G64Wn	Australia/ New Zealand	LX.PUG0 2.006	N	N640GB5.4KS	N	NBDRW4 XS
AS8943G-728G1.14T Bn	Spain	LX.PUG0 2.001	SO2GBII I10	N500GB5.4KS	N640GB5.4KS	NBDCB4 XS
AS8943G-728G1.28T Bn	Algeria	LX.PUH0 2.173	SO2GBII I10	N640GB5.4KS	N640GB5.4KS	NBDCB4 XS
AS8943G-728G1.28T Bn	Austria	LX.PUH0 2.140	SO2GBII I10	N640GB5.4KS	N640GB5.4KS	NBDCB4 XS

Model	Country	Acer P/N	Memory 4	HDD 1(GB)	HDD 2(GB)	ODD
AS8943G-728G1.28T Bn	Baltic	LX.PUH0 2.164	SO2GBII I10	N640GB5.4KS	N640GB5.4KS	NBDCB4 XS
AS8943G-728G1.28T Bn	Baltic	LX.PUH0 2.151	SO2GBII I10	N640GB5.4KS	N640GB5.4KS	NBDCB4 XS
AS8943G-728G1.28T Bn	Baltic	LX.PUH0 2.148	SO2GBII I10	N640GB5.4KS	N640GB5.4KS	NBDCB4 XS
AS8943G-728G1.28T Bn	Belgium	LX.PUH0 2.161	SO2GBII I10	N640GB5.4KS	N640GB5.4KS	NBDCB4 XS
AS8943G-728G1.28T Bn	Cyprus	LX.PUH0 2.150	SO2GBII I10	N640GB5.4KS	N640GB5.4KS	NBDCB4 XS
AS8943G-728G1.28T Bn	Czech	LX.PUH0 2.154	SO2GBII I10	N640GB5.4KS	N640GB5.4KS	NBDCB4 XS
AS8943G-728G1.28T Bn	Denmark	LX.PUH0 2.146	SO2GBII I10	N640GB5.4KS	N640GB5.4KS	NBDCB4 XS
AS8943G-728G1.28T Bn	Eastern Europe	LX.PUH0 2.157	SO2GBII I10	N640GB5.4KS	N640GB5.4KS	NBDCB4 XS
AS8943G-728G1.28T Bn	Eastern Europe	LX.PUH0 2.156	SO2GBII I10	N640GB5.4KS	N640GB5.4KS	NBDCB4 XS
AS8943G-728G1.28T Bn	Eastern Europe	LX.PUH0 2.145	SO2GBII I10	N640GB5.4KS	N640GB5.4KS	NBDCB4 XS
AS8943G-728G1.28T Bn	Eastern Europe	LX.PUH0 2.144	SO2GBII I10	N640GB5.4KS	N640GB5.4KS	NBDCB4 XS
AS8943G-728G1.28T Bn	Eastern Europe	LX.PUH0 2.139	SO2GBII I10	N640GB5.4KS	N640GB5.4KS	NBDCB4 XS
AS8943G-728G1.28T Bn	France	LX.PUH0 2.138	SO2GBII I10	N640GB5.4KS	N640GB5.4KS	NBDCB4 XS
AS8943G-728G1.28T Bn	Germany	LX.PUH0 2.165	SO2GBII I10	N640GB5.4KS	N640GB5.4KS	NBDCB4 XS
AS8943G-728G1.28T Bn	Greece	LX.PUH0 2.141	SO2GBII I10	N640GB5.4KS	N640GB5.4KS	NBDCB4 XS
AS8943G-728G1.28T Bn	Holland	LX.PUH0 2.162	SO2GBII I10	N640GB5.4KS	N640GB5.4KS	NBDCB4 XS
AS8943G-728G1.28T Bn	Hungary	LX.PUH0 2.153	SO2GBII I10	N640GB5.4KS	N640GB5.4KS	NBDCB4 XS

Model	Country	Acer P/N	Memory 4	HDD 1(GB)	HDD 2(GB)	ODD
AS8943G-728G1.28T Bn	Israel	LX.PUH0 2.152	SO2GBII I10	N640GB5.4KS	N640GB5.4KS	NBDCB4 XS
AS8943G-728G1.28T Bn	Italy	LX.PUH0 2.143	SO2GBII I10	N640GB5.4KS	N640GB5.4KS	NBDCB4 XS
AS8943G-728G1.28T Bn	Latvia	LX.PUH0 2.159	SO2GBII I10	N640GB5.4KS	N640GB5.4KS	NBDCB4 XS
AS8943G-728G1.28T Bn	Latvia	LX.PUH0 2.158	SO2GBII I10	N640GB5.4KS	N640GB5.4KS	NBDCB4 XS
AS8943G-728G1.28T Bn	Luxembourg	LX.PUH0 2.163	SO2GBII I10	N640GB5.4KS	N640GB5.4KS	NBDCB4 XS
AS8943G-728G1.28T Bn	Middle East	LX.PUH0 2.180	SO2GBII I10	N640GB5.4KS	N640GB5.4KS	NBDCB4 XS
AS8943G-728G1.28T Bn	Middle East	LX.PUH0 2.179	SO2GBII I10	N640GB5.4KS	N640GB5.4KS	NBDCB4 XS
AS8943G-728G1.28T Bn	Middle East	LX.PUH0 2.176	SO2GBII I10	N640GB5.4KS	N640GB5.4KS	NBDCB4 XS
AS8943G-728G1.28T Bn	Middle East	LX.PUH0 2.175	SO2GBII I10	N640GB5.4KS	N640GB5.4KS	NBDCB4 XS
AS8943G-728G1.28T Bn	Middle East	LX.PUH0 2.174	SO2GBII I10	N640GB5.4KS	N640GB5.4KS	NBDCB4 XS
AS8943G-728G1.28T Bn	Middle East	LX.PUH0 2.171	SO2GBII I10	N640GB5.4KS	N640GB5.4KS	NBDCB4 XS
AS8943G-728G1.28T Bn	Middle East	LX.PUH0 2.170	SO2GBII I10	N640GB5.4KS	N640GB5.4KS	NBDCB4 XS
AS8943G-728G1.28T Bn	Middle East	LX.PUH0 2.169	SO2GBII I10	N640GB5.4KS	N640GB5.4KS	NBDCB4 XS
AS8943G-728G1.28T Bn	Middle East	LX.PUH0 2.168	SO2GBII I10	N640GB5.4KS	N640GB5.4KS	NBDCB4 XS
AS8943G-728G1.28T Bn	Poland	LX.PUH0 2.166	SO2GBII I10	N640GB5.4KS	N640GB5.4KS	NBDCB4 XS
AS8943G-728G1.28T Bn	Portugal	LX.PUH0 2.149	SO2GBII I10	N640GB5.4KS	N640GB5.4KS	NBDCB4 XS
AS8943G-728G1.28T Bn	Serbia/Macedonia	LX.PUH0 2.147	SO2GBII I10	N640GB5.4KS	N640GB5.4KS	NBDCB4 XS

Model	Country	Acer P/N	Memory 4	HDD 1(GB)	HDD 2(GB)	ODD
AS8943G-728G1.28T Bn	South Africa	LX.PUH0 2.178	SO2GBII I10	N640GB5.4KS	N640GB5.4KS	NBDCB4 XS
AS8943G-728G1.28T Bn	South Africa	LX.PUH0 2.172	SO2GBII I10	N640GB5.4KS	N640GB5.4KS	NBDCB4 XS
AS8943G-728G1.28T Bn	South Africa	LX.PUH0 2.167	SO2GBII I10	N640GB5.4KS	N640GB5.4KS	NBDCB4 XS
AS8943G-728G1.28T Bn	Spain	LX.PUH0 2.142	SO2GBII I10	N640GB5.4KS	N640GB5.4KS	NBDCB4 XS
AS8943G-728G1.28T Bn	Switzerland	LX.PUH0 2.160	SO2GBII I10	N640GB5.4KS	N640GB5.4KS	NBDCB4 XS
AS8943G-728G1.28T Bn	Turkey	LX.PUH0 2.177	SO2GBII I10	N640GB5.4KS	N640GB5.4KS	NBDCB4 XS
AS8943G-728G1.28T Bn	UK	LX.PUH0 2.155	SO2GBII I10	N640GB5.4KS	N640GB5.4KS	NBDCB4 XS
AS8943G-728G1.28T Wi	Russia	LX.PUH0 2.254	SO2GBII I10	N640GB5.4KS	N640GB5.4KS	NBDRW4 XS
AS8943G-728G1.28T Wn	Australia/ New Zealand	LX.PUG0 2.007	SO2GBII I10	N640GB5.4KS	N640GB5.4KS	NBDRW4 XS
AS8943G-728G1.28T Wn	Czech	LX.PUG0 2.011	SO2GBII I10	N640GB5.4KS	N640GB5.4KS	NBDRW4 XS
AS8943G-728G1.28T Wn	France	LX.PUG0 2.004	SO2GBII I10	N640GB5.4KS	N640GB5.4KS	NBDRW4 XS
AS8943G-728G1.28T Wn	Germany	LX.PUH0 2.251	SO2GBII I10	N640GB5.4KS	N640GB5.4KS	NBDRW4 XS
AS8943G-728G1.28T Wn	Philippines	LX.PUH0 2.250	N	N640GB5.4KS	N640GB5.4KS	NBDRW4 XS
AS8943G-728G1.28T Wn	Singapore	LX.PUH0 2.189	N	N640GB5.4KS	N640GB5.4KS	NBDRW4 XS
AS8943G-728G1.28T Wn	Singapore	LX.PUG0 2.008	N	N640GB5.4KS	N640GB5.4KS	NBDRW4 XS
AS8943G-728G1.28T Wn	Switzerland	LX.PUH0 2.185	SO2GBII I10	N640GB5.4KS	N640GB5.4KS	NBDRW4 XS
AS8943G-728G1.28T Wn	Switzerland	LX.PUH0 2.184	SO2GBII I10	N640GB5.4KS	N640GB5.4KS	NBDRW4 XS

Model	Country	Acer P/N	Memory 4	HDD 1(GB)	HDD 2(GB)	ODD
AS8943G-728G1.28T Wn	Switzerland	LX.PUG0 2.005	SO2GBII I10	N640GB5.4KS	N640GB5.4KS	NBDRW4 XS
AS8943G-728G1.28T Wn	Thailand	LX.PUH0 2.253	SO2GBII I10	N640GB5.4KS	N640GB5.4KS	NBDRW4 XS
AS8943G-728G1.28T Wn	Thailand	LX.PUH0 2.252	N	N640GB5.4KS	N640GB5.4KS	NBDRW4 XS
AS8943G-728G1TBi	Russia	LX.PUH0 2.136	SO2GBII I10	N500GB5.4KS	N500GB5.4KS	NBDCB4 XS
AS8943G-728G1TBn	Algeria	LX.PUH0 2.128	SO2GBII I10	N500GB5.4KS	N500GB5.4KS	NBDCB4 XS
AS8943G-728G1TBn	Austria	LX.PUH0 2.094	SO2GBII I10	N500GB5.4KS	N500GB5.4KS	NBDCB4 XS
AS8943G-728G1TBn	Baltic	LX.PUH0 2.119	SO2GBII I10	N500GB5.4KS	N500GB5.4KS	NBDCB4 XS
AS8943G-728G1TBn	Baltic	LX.PUH0 2.102	SO2GBII I10	N500GB5.4KS	N500GB5.4KS	NBDCB4 XS
AS8943G-728G1TBn	Baltic	LX.PUH0 2.098	SO2GBII I10	N500GB5.4KS	N500GB5.4KS	NBDCB4 XS
AS8943G-728G1TBn	Belgium	LX.PUH0 2.116	SO2GBII I10	N500GB5.4KS	N500GB5.4KS	NBDCB4 XS
AS8943G-728G1TBn	Cyprus	LX.PUH0 2.101	SO2GBII I10	N500GB5.4KS	N500GB5.4KS	NBDCB4 XS
AS8943G-728G1TBn	Czech	LX.PUH0 2.105	SO2GBII I10	N500GB5.4KS	N500GB5.4KS	NBDCB4 XS
AS8943G-728G1TBn	Denmark	LX.PUH0 2.096	SO2GBII I10	N500GB5.4KS	N500GB5.4KS	NBDCB4 XS
AS8943G-728G1TBn	Eastern Europe	LX.PUH0 2.112	SO2GBII I10	N500GB5.4KS	N500GB5.4KS	NBDCB4 XS
AS8943G-728G1TBn	Eastern Europe	LX.PUH0 2.111	SO2GBII I10	N500GB5.4KS	N500GB5.4KS	NBDCB4 XS
AS8943G-728G1TBn	Eastern Europe	LX.PUH0 2.110	SO2GBII I10	N500GB5.4KS	N500GB5.4KS	NBDCB4 XS
AS8943G-728G1TBn	Eastern Europe	LX.PUH0 2.107	SO2GBII I10	N500GB5.4KS	N500GB5.4KS	NBDCB4 XS
AS8943G-728G1TBn	Eastern Europe	LX.PUH0 2.093	SO2GBII I10	N500GB5.4KS	N500GB5.4KS	NBDCB4 XS
AS8943G-728G1TBn	France	LX.PUH0 2.092	SO2GBII I10	N500GB5.4KS	N500GB5.4KS	NBDCB4 XS
AS8943G-728G1TBn	Germany	LX.PUH0 2.120	SO2GBII I10	N500GB5.4KS	N500GB5.4KS	NBDCB4 XS
AS8943G-728G1TBn	Greece	LX.PUH0 2.095	SO2GBII I10	N500GB5.4KS	N500GB5.4KS	NBDCB4 XS
AS8943G-728G1TBn	Holland	LX.PUH0 2.117	SO2GBII I10	N500GB5.4KS	N500GB5.4KS	NBDCB4 XS
AS8943G-728G1TBn	Hungary	LX.PUH0 2.104	SO2GBII I10	N500GB5.4KS	N500GB5.4KS	NBDCB4 XS

Model	Country	Acer P/N	Memory 4	HDD 1(GB)	HDD 2(GB)	ODD
AS8943G-728G1TBn	Israel	LX.PUH0 2.103	SO2GBII I10	N500GB5.4KS	N500GB5.4KS	NBDCB4 XS
AS8943G-728G1TBn	Italy	LX.PUH0 2.109	SO2GBII I10	N500GB5.4KS	N500GB5.4KS	NBDCB4 XS
AS8943G-728G1TBn	Latvia	LX.PUH0 2.114	SO2GBII I10	N500GB5.4KS	N500GB5.4KS	NBDCB4 XS
AS8943G-728G1TBn	Latvia	LX.PUH0 2.113	SO2GBII I10	N500GB5.4KS	N500GB5.4KS	NBDCB4 XS
AS8943G-728G1TBn	Luxembourg	LX.PUH0 2.118	SO2GBII I10	N500GB5.4KS	N500GB5.4KS	NBDCB4 XS
AS8943G-728G1TBn	Middle East	LX.PUH0 2.135	SO2GBII I10	N500GB5.4KS	N500GB5.4KS	NBDCB4 XS
AS8943G-728G1TBn	Middle East	LX.PUH0 2.134	SO2GBII I10	N500GB5.4KS	N500GB5.4KS	NBDCB4 XS
AS8943G-728G1TBn	Middle East	LX.PUH0 2.131	SO2GBII I10	N500GB5.4KS	N500GB5.4KS	NBDCB4 XS
AS8943G-728G1TBn	Middle East	LX.PUH0 2.130	SO2GBII I10	N500GB5.4KS	N500GB5.4KS	NBDCB4 XS
AS8943G-728G1TBn	Middle East	LX.PUH0 2.129	SO2GBII I10	N500GB5.4KS	N500GB5.4KS	NBDCB4 XS
AS8943G-728G1TBn	Middle East	LX.PUH0 2.126	SO2GBII I10	N500GB5.4KS	N500GB5.4KS	NBDCB4 XS
AS8943G-728G1TBn	Middle East	LX.PUH0 2.125	SO2GBII I10	N500GB5.4KS	N500GB5.4KS	NBDCB4 XS
AS8943G-728G1TBn	Middle East	LX.PUH0 2.124	SO2GBII I10	N500GB5.4KS	N500GB5.4KS	NBDCB4 XS
AS8943G-728G1TBn	Middle East	LX.PUH0 2.123	SO2GBII I10	N500GB5.4KS	N500GB5.4KS	NBDCB4 XS
AS8943G-728G1TBn	Poland	LX.PUH0 2.121	SO2GBII I10	N500GB5.4KS	N500GB5.4KS	NBDCB4 XS
AS8943G-728G1TBn	Portugal	LX.PUH0 2.099	SO2GBII I10	N500GB5.4KS	N500GB5.4KS	NBDCB4 XS
AS8943G-728G1TBn	Serbia/Macedonia	LX.PUH0 2.097	SO2GBII I10	N500GB5.4KS	N500GB5.4KS	NBDCB4 XS
AS8943G-728G1TBn	South Africa	LX.PUH0 2.133	SO2GBII I10	N500GB5.4KS	N500GB5.4KS	NBDCB4 XS
AS8943G-728G1TBn	South Africa	LX.PUH0 2.127	SO2GBII I10	N500GB5.4KS	N500GB5.4KS	NBDCB4 XS
AS8943G-728G1TBn	South Africa	LX.PUH0 2.122	SO2GBII I10	N500GB5.4KS	N500GB5.4KS	NBDCB4 XS
AS8943G-728G1TBn	Spain	LX.PUH0 2.108	SO2GBII I10	N500GB5.4KS	N500GB5.4KS	NBDCB4 XS
AS8943G-728G1TBn	Spain	LX.PUG0 2.002	SO2GBII I10	N500GB5.4KS	N500GB5.4KS	NBDCB4 XS
AS8943G-728G1TBn	Switzerland	LX.PUH0 2.186	SO2GBII I10	N500GB5.4KS	N500GB5.4KS	NBDCB4 XS
AS8943G-728G1TBn	Switzerland	LX.PUH0 2.115	SO2GBII I10	N500GB5.4KS	N500GB5.4KS	NBDCB4 XS

Model	Country	Acer P/N	Memory 4	HDD 1(GB)	HDD 2(GB)	ODD
AS8943G-728G1TBn	Turkey	LX.PUH0 2.132	SO2GBII I10	N500GB5.4KS	N500GB5.4KS	NBDCB4 XS
AS8943G-728G1TBn	UK	LX.PUH0 2.106	SO2GBII I10	N500GB5.4KS	N500GB5.4KS	NBDCB4 XS
AS8943G-728G1TBn	Ukraine	LX.PUH0 2.137	SO2GBII I10	N500GB5.4KS	N500GB5.4KS	NBDCB4 XS
AS8943G-728G1TMn	GCTWN	S2.PUG0 2.001	SO2GBII I10	N500GB5.4KS	N500GB5.4KS	NSM8XS
AS8943G-728G1TMn	GCTWN	S2.PUG0 2.001	SO2GBII I10	N500GB5.4KS	N500GB5.4KS	NSM8XS
AS8943G-728G1TMn	WW	S2.PUH0 2.001	SO2GBII I10	N500GB5.4KS	N500GB5.4KS	NSM8XS
AS8943G-728G1TMn	WW	S2.PUH0 2.001	SO2GBII I10	N500GB5.4KS	N500GB5.4KS	NSM8XS
AS8943G-728G1TWi	Russia	LX.PUH0 2.187	SO2GBII I10	N500GB5.4KS	N500GB5.4KS	NBDRW4 XS
AS8943G-728G1TWn	UK	LX.PUG0 2.013	SO2GBII I10	N500GB5.4KS	N500GB5.4KS	NBDRW4 XS
AS8943G-728G64Bi	Russia	LX.PUH0 2.090	SO2GBII I10	N640GB5.4KS	N	NBDCB4 XS
AS8943G-728G64Bn	Algeria	LX.PUH0 2.082	SO2GBII I10	N640GB5.4KS	N	NBDCB4 XS
AS8943G-728G64Bn	Austria	LX.PUH0 2.049	SO2GBII I10	N640GB5.4KS	N	NBDCB4 XS
AS8943G-728G64Bn	Baltic	LX.PUH0 2.073	SO2GBII I10	N640GB5.4KS	N	NBDCB4 XS
AS8943G-728G64Bn	Baltic	LX.PUH0 2.060	SO2GBII I10	N640GB5.4KS	N	NBDCB4 XS
AS8943G-728G64Bn	Baltic	LX.PUH0 2.057	SO2GBII I10	N640GB5.4KS	N	NBDCB4 XS
AS8943G-728G64Bn	Belgium	LX.PUH0 2.070	SO2GBII I10	N640GB5.4KS	N	NBDCB4 XS
AS8943G-728G64Bn	Cyprus	LX.PUH0 2.059	SO2GBII I10	N640GB5.4KS	N	NBDCB4 XS
AS8943G-728G64Bn	Czech	LX.PUH0 2.063	SO2GBII I10	N640GB5.4KS	N	NBDCB4 XS
AS8943G-728G64Bn	Denmark	LX.PUH0 2.055	SO2GBII I10	N640GB5.4KS	N	NBDCB4 XS
AS8943G-728G64Bn	Eastern Europe	LX.PUH0 2.066	SO2GBII I10	N640GB5.4KS	N	NBDCB4 XS
AS8943G-728G64Bn	Eastern Europe	LX.PUH0 2.065	SO2GBII I10	N640GB5.4KS	N	NBDCB4 XS
AS8943G-728G64Bn	Eastern Europe	LX.PUH0 2.054	SO2GBII I10	N640GB5.4KS	N	NBDCB4 XS
AS8943G-728G64Bn	Eastern Europe	LX.PUH0 2.053	SO2GBII I10	N640GB5.4KS	N	NBDCB4 XS
AS8943G-728G64Bn	Eastern Europe	LX.PUH0 2.048	SO2GBII I10	N640GB5.4KS	N	NBDCB4 XS

Model	Country	Acer P/N	Memory 4	HDD 1(GB)	HDD 2(GB)	ODD
AS8943G-728G64Bn	France	LX.PUH0 2.047	SO2GBII I10	N640GB5.4KS	N	NBDCB4 XS
AS8943G-728G64Bn	Germany	LX.PUH0 2.074	SO2GBII I10	N640GB5.4KS	N	NBDCB4 XS
AS8943G-728G64Bn	Greece	LX.PUH0 2.050	SO2GBII I10	N640GB5.4KS	N	NBDCB4 XS
AS8943G-728G64Bn	Holland	LX.PUH0 2.071	SO2GBII I10	N640GB5.4KS	N	NBDCB4 XS
AS8943G-728G64Bn	Hungary	LX.PUH0 2.062	SO2GBII I10	N640GB5.4KS	N	NBDCB4 XS
AS8943G-728G64Bn	Israel	LX.PUH0 2.061	SO2GBII I10	N640GB5.4KS	N	NBDCB4 XS
AS8943G-728G64Bn	Italy	LX.PUH0 2.052	SO2GBII I10	N640GB5.4KS	N	NBDCB4 XS
AS8943G-728G64Bn	Latvia	LX.PUH0 2.068	SO2GBII I10	N640GB5.4KS	N	NBDCB4 XS
AS8943G-728G64Bn	Latvia	LX.PUH0 2.067	SO2GBII I10	N640GB5.4KS	N	NBDCB4 XS
AS8943G-728G64Bn	Luxembourg	LX.PUH0 2.072	SO2GBII I10	N640GB5.4KS	N	NBDCB4 XS
AS8943G-728G64Bn	Middle East	LX.PUH0 2.089	SO2GBII I10	N640GB5.4KS	N	NBDCB4 XS
AS8943G-728G64Bn	Middle East	LX.PUH0 2.088	SO2GBII I10	N640GB5.4KS	N	NBDCB4 XS
AS8943G-728G64Bn	Middle East	LX.PUH0 2.085	SO2GBII I10	N640GB5.4KS	N	NBDCB4 XS
AS8943G-728G64Bn	Middle East	LX.PUH0 2.084	SO2GBII I10	N640GB5.4KS	N	NBDCB4 XS
AS8943G-728G64Bn	Middle East	LX.PUH0 2.083	SO2GBII I10	N640GB5.4KS	N	NBDCB4 XS
AS8943G-728G64Bn	Middle East	LX.PUH0 2.080	SO2GBII I10	N640GB5.4KS	N	NBDCB4 XS
AS8943G-728G64Bn	Middle East	LX.PUH0 2.079	SO2GBII I10	N640GB5.4KS	N	NBDCB4 XS
AS8943G-728G64Bn	Middle East	LX.PUH0 2.078	SO2GBII I10	N640GB5.4KS	N	NBDCB4 XS
AS8943G-728G64Bn	Middle East	LX.PUH0 2.077	SO2GBII I10	N640GB5.4KS	N	NBDCB4 XS
AS8943G-728G64Bn	Poland	LX.PUH0 2.075	SO2GBII I10	N640GB5.4KS	N	NBDCB4 XS
AS8943G-728G64Bn	Portugal	LX.PUH0 2.058	SO2GBII I10	N640GB5.4KS	N	NBDCB4 XS
AS8943G-728G64Bn	Serbia/ Macedonia	LX.PUH0 2.056	SO2GBII I10	N640GB5.4KS	N	NBDCB4 XS
AS8943G-728G64Bn	South Africa	LX.PUH0 2.087	SO2GBII I10	N640GB5.4KS	N	NBDCB4 XS
AS8943G-728G64Bn	South Africa	LX.PUH0 2.081	SO2GBII I10	N640GB5.4KS	N	NBDCB4 XS

Model	Country	Acer P/N	Memory 4	HDD 1(GB)	HDD 2(GB)	ODD
AS8943G-728G64Bn	South Africa	LX.PUH0 2.076	SO2GBII I10	N640GB5.4KS	N	NBDCB4 XS
AS8943G-728G64Bn	Spain	LX.PUH0 2.051	SO2GBII I10	N640GB5.4KS	N	NBDCB4 XS
AS8943G-728G64Bn	Switzerland	LX.PUH0 2.069	SO2GBII I10	N640GB5.4KS	N	NBDCB4 XS
AS8943G-728G64Bn	Turkey	LX.PUH0 2.086	SO2GBII I10	N640GB5.4KS	N	NBDCB4 XS
AS8943G-728G64Bn	UK	LX.PUH0 2.064	SO2GBII I10	N640GB5.4KS	N	NBDCB4 XS
AS8943G-728G64Bn	Ukraine	LX.PUH0 2.091	SO2GBII I10	N640GB5.4KS	N	NBDCB4 XS
AS8943G-82121.28T Bn	WW	S2.PWC 02.007	SO4GBII I10	N640GB5.4KS	N640GB5.4KS	NBDCB4 XS
AS8943G-82121.28T Bn	WW	S2.PWC 02.007	SO4GBII I10	N640GB5.4KS	N640GB5.4KS	NBDCB4 XS
AS8943G-82161.28T Wn	UK	LX.PWC 02.075	SO4GBII I10	N640GB5.4KS	N640GB5.4KS	NBDRW4 XS
AS8943G-82161.28T Wn	WW	S2.PU10 2.001	SO4GBII I10	N640GB5.4KS	N640GB5.4KS	NBDRW4 XS
AS8943G-82161.28T Wn	WW	S2.PU10 2.001	SO4GBII I10	N640GB5.4KS	N640GB5.4KS	NBDRW4 XS
AS8943G-828G1.28T Mn	Philippines	LX.PUH0 2.243	N	N640GB5.4KS	N640GB5.4KS	NSM8XS

Model	Country	Acer P/N	Wireless LAN1	Bluetooth
AS8943G-332G57Mn	WW	S2.PTL02.001	3rd WiFi 2x2 BGN	BT 2.1
AS8943G-332G57Mn	WW	S2.PTL02.001	3rd WiFi 2x2 BGN	BT 2.1
AS8943G-333G32Mn	Turkey	LX.PUJ02.058	3rd WiFi 2x2 BGN	BT 2.1
AS8943G-334G50Mi	Russia	LX.PUJ02.006	3rd WiFi BG	N
AS8943G-334G50Mn	France	LX.PUJ02.004	3rd WiFi 2x2 BGN	BT 2.1
AS8943G-334G64Mn	Belgium	LX.PU202.005	3rd WiFi 2x2 BGN	BT 2.1
AS8943G-334G64Mn	Holland	LX.PU202.004	3rd WiFi 2x2 BGN	BT 2.1
AS8943G-334G64Mn	Luxembourg	LX.PU202.003	3rd WiFi 2x2 BGN	BT 2.1

Model	Country	Acer P/N	Wireless LAN1	Bluetooth
AS8943G-354G50Mn	France	LX.PUJ02.059	3rd WiFi 2x2 BGN	BT 2.1
AS8943G-432G82Mn	WW	S2.PTL02.003	3rd WiFi 2x2 BGN	BT 2.1
AS8943G-432G82Mn	WW	S2.PTL02.003	3rd WiFi 2x2 BGN	BT 2.1
AS8943G-434G1TBi	Russia	LX.PUJ02.051	3rd WiFi BG	BT 2.1
AS8943G-434G1TBn	Algeria	LX.PUJ02.027	3rd WiFi 2x2 BGN	BT 2.1
AS8943G-434G1TBn	Austria	LX.PUJ02.009	3rd WiFi 2x2 BGN	BT 2.1
AS8943G-434G1TBn	Baltic	LX.PUJ02.047	3rd WiFi 2x2 BGN	BT 2.1
AS8943G-434G1TBn	Baltic	LX.PUJ02.020	3rd WiFi 2x2 BGN	BT 2.1
AS8943G-434G1TBn	Baltic	LX.PUJ02.017	3rd WiFi 2x2 BGN	BT 2.1
AS8943G-434G1TBn	Belgium	LX.PUJ02.045	3rd WiFi 2x2 BGN	BT 2.1
AS8943G-434G1TBn	Cyprus	LX.PUJ02.018	3rd WiFi 2x2 BGN	BT 2.1
AS8943G-434G1TBn	Czech	LX.PUJ02.037	3rd WiFi 2x2 BGN	BT 2.1
AS8943G-434G1TBn	Denmark	LX.PUJ02.013	3rd WiFi 2x2 BGN	BT 2.1
AS8943G-434G1TBn	Eastern Europe	LX.PUJ02.039	3rd WiFi 2x2 BGN	BT 2.1
AS8943G-434G1TBn	Eastern Europe	LX.PUJ02.038	3rd WiFi 2x2 BGN	BT 2.1
AS8943G-434G1TBn	Eastern Europe	LX.PUJ02.012	3rd WiFi 2x2 BGN	BT 2.1
AS8943G-434G1TBn	Eastern Europe	LX.PUJ02.011	3rd WiFi 2x2 BGN	BT 2.1
AS8943G-434G1TBn	Eastern Europe	LX.PUJ02.007	3rd WiFi 2x2 BGN	BT 2.1
AS8943G-434G1TBn	France	LX.PUJ02.008	3rd WiFi 2x2 BGN	BT 2.1
AS8943G-434G1TBn	Germany	LX.PUJ02.049	3rd WiFi 2x2 BGN	BT 2.1
AS8943G-434G1TBn	Greece	LX.PUJ02.010	3rd WiFi 2x2 BGN	BT 2.1
AS8943G-434G1TBn	Holland	LX.PUJ02.046	3rd WiFi 2x2 BGN	BT 2.1
AS8943G-434G1TBn	Hungary	LX.PUJ02.036	3rd WiFi 2x2 BGN	BT 2.1
AS8943G-434G1TBn	Israel	LX.PUJ02.035	3rd WiFi 2x2 BGN	BT 2.1
AS8943G-434G1TBn	Italy	LX.PUJ02.015	3rd WiFi 2x2 BGN	BT 2.1

Model	Country	Acer P/N	Wireless LAN1	Bluetooth
AS8943G-434G1TBn	Latvia	LX.PUJ02.042	3rd WiFi 2x2 BGN	BT 2.1
AS8943G-434G1TBn	Latvia	LX.PUJ02.041	3rd WiFi 2x2 BGN	BT 2.1
AS8943G-434G1TBn	Luxembourg	LX.PUJ02.043	3rd WiFi 2x2 BGN	BT 2.1
AS8943G-434G1TBn	Middle East	LX.PUJ02.050	3rd WiFi 2x2 BGN	BT 2.1
AS8943G-434G1TBn	Middle East	LX.PUJ02.034	3rd WiFi 2x2 BGN	BT 2.1
AS8943G-434G1TBn	Middle East	LX.PUJ02.031	3rd WiFi 2x2 BGN	BT 2.1
AS8943G-434G1TBn	Middle East	LX.PUJ02.030	3rd WiFi 2x2 BGN	BT 2.1
AS8943G-434G1TBn	Middle East	LX.PUJ02.028	3rd WiFi 2x2 BGN	BT 2.1
AS8943G-434G1TBn	Middle East	LX.PUJ02.025	3rd WiFi 2x2 BGN	BT 2.1
AS8943G-434G1TBn	Middle East	LX.PUJ02.024	3rd WiFi 2x2 BGN	BT 2.1
AS8943G-434G1TBn	Middle East	LX.PUJ02.023	3rd WiFi 2x2 BGN	BT 2.1
AS8943G-434G1TBn	Middle East	LX.PUJ02.022	3rd WiFi 2x2 BGN	BT 2.1
AS8943G-434G1TBn	Poland	LX.PUJ02.048	3rd WiFi 2x2 BGN	BT 2.1
AS8943G-434G1TBn	Portugal	LX.PUJ02.019	3rd WiFi 2x2 BGN	BT 2.1
AS8943G-434G1TBn	Serbia/Macedonia	LX.PUJ02.016	3rd WiFi 2x2 BGN	BT 2.1
AS8943G-434G1TBn	South Africa	LX.PUJ02.033	3rd WiFi 2x2 BGN	BT 2.1
AS8943G-434G1TBn	South Africa	LX.PUJ02.029	3rd WiFi 2x2 BGN	BT 2.1
AS8943G-434G1TBn	South Africa	LX.PUJ02.026	3rd WiFi 2x2 BGN	BT 2.1
AS8943G-434G1TBn	South Africa	LX.PUJ02.021	3rd WiFi 2x2 BGN	BT 2.1
AS8943G-434G1TBn	Spain	LX.PUJ02.014	3rd WiFi 2x2 BGN	BT 2.1
AS8943G-434G1TBn	Switzerland	LX.PUJ02.044	3rd WiFi 2x2 BGN	BT 2.1
AS8943G-434G1TBn	Turkey	LX.PUJ02.032	3rd WiFi 2x2 BGN	BT 2.1
AS8943G-434G1TBn	UK	LX.PUJ02.040	3rd WiFi 2x2 BGN	BT 2.1
AS8943G-434G1TBn	Ukraine	LX.PUJ02.052	3rd WiFi 2x2 BGN	BT 2.1
AS8943G-434G1TMn	Belgium	LX.PUJ02.055	3rd WiFi 2x2 BGN	BT 2.1

Model	Country	Acer P/N	Wireless LAN1	Bluetooth
AS8943G-434G1TMn	France	LX.PUJ02.003	3rd WiFi 2x2 BGN	BT 2.1
AS8943G-434G1TMn	Holland	LX.PUJ02.054	3rd WiFi 2x2 BGN	BT 2.1
AS8943G-434G1TMn	Luxembourg	LX.PUJ02.053	3rd WiFi 2x2 BGN	BT 2.1
AS8943G-434G32Mn	Austria	LX.PU202.006	3rd WiFi 2x2 BGN	N
AS8943G-434G32Mn	Germany	LX.PU202.002	3rd WiFi 2x2 BGN	N
AS8943G-434G50Bn	UK	LX.PU202.007	3rd WiFi 2x2 BGN	BT 2.1
AS8943G-434G50Mn	Denmark	LX.PU102.092	3rd WiFi 2x2 BGN	BT 2.1
AS8943G-434G50Mn	Spain	LX.PUJ02.001	3rd WiFi 2x2 BGN	N
AS8943G-434G50Mn	Turkey	LX.PUJ02.056	3rd WiFi 2x2 BGN	BT 2.1
AS8943G-434G64Bi	Russia	LX.PU102.099	3rd WiFi BG	BT 2.1
AS8943G-434G64Bn	Czech	LX.PU102.103	3rd WiFi 2x2 BGN	BT 2.1
AS8943G-434G64Mi	Russia	LX.PUJ02.060	3rd WiFi BG	BT 2.1
AS8943G-434G64Mi	Russia	LX.PU102.044	3rd WiFi BG	N
AS8943G-434G64Mn	Algeria	LX.PU102.036	3rd WiFi 2x2 BGN	N
AS8943G-434G64Mn	Austria	LX.PU102.003	3rd WiFi 2x2 BGN	N
AS8943G-434G64Mn	Baltic	LX.PU102.022	3rd WiFi 2x2 BGN	N
AS8943G-434G64Mn	Baltic	LX.PU102.014	3rd WiFi 2x2 BGN	N
AS8943G-434G64Mn	Baltic	LX.PU102.011	3rd WiFi 2x2 BGN	N
AS8943G-434G64Mn	Belgium	LX.PU102.033	3rd WiFi 2x2 BGN	N
AS8943G-434G64Mn	Cyprus	LX.PU102.013	3rd WiFi 2x2 BGN	N
AS8943G-434G64Mn	Czech	LX.PU102.017	3rd WiFi 2x2 BGN	N
AS8943G-434G64Mn	Denmark	LX.PU102.009	3rd WiFi 2x2 BGN	N
AS8943G-434G64Mn	Eastern Europe	LX.PU102.020	3rd WiFi 2x2 BGN	N
AS8943G-434G64Mn	Eastern Europe	LX.PU102.019	3rd WiFi 2x2 BGN	N
AS8943G-434G64Mn	Eastern Europe	LX.PU102.008	3rd WiFi 2x2 BGN	N

Model	Country	Acer P/N	Wireless LAN1	Bluetooth
AS8943G-434G64Mn	Eastern Europe	LX.PU102.007	3rd WiFi 2x2 BGN	N
AS8943G-434G64Mn	Eastern Europe	LX.PU102.002	3rd WiFi 2x2 BGN	N
AS8943G-434G64Mn	France	LX.PU102.001	3rd WiFi 2x2 BGN	N
AS8943G-434G64Mn	Germany	LX.PU102.023	3rd WiFi 2x2 BGN	N
AS8943G-434G64Mn	Greece	LX.PU102.004	3rd WiFi 2x2 BGN	N
AS8943G-434G64Mn	Holland	LX.PU102.034	3rd WiFi 2x2 BGN	N
AS8943G-434G64Mn	Hungary	LX.PU102.016	3rd WiFi 2x2 BGN	N
AS8943G-434G64Mn	Israel	LX.PU102.015	3rd WiFi 2x2 BGN	N
AS8943G-434G64Mn	Italy	LX.PU102.006	3rd WiFi 2x2 BGN	N
AS8943G-434G64Mn	Latvia	LX.PU102.031	3rd WiFi 2x2 BGN	N
AS8943G-434G64Mn	Latvia	LX.PU102.021	3rd WiFi 2x2 BGN	N
AS8943G-434G64Mn	Luxembourg	LX.PU102.035	3rd WiFi 2x2 BGN	N
AS8943G-434G64Mn	Middle East	LX.PU102.043	3rd WiFi 2x2 BGN	N
AS8943G-434G64Mn	Middle East	LX.PU102.042	3rd WiFi 2x2 BGN	N
AS8943G-434G64Mn	Middle East	LX.PU102.039	3rd WiFi 2x2 BGN	N
AS8943G-434G64Mn	Middle East	LX.PU102.038	3rd WiFi 2x2 BGN	N
AS8943G-434G64Mn	Middle East	LX.PU102.037	3rd WiFi 2x2 BGN	N
AS8943G-434G64Mn	Middle East	LX.PU102.029	3rd WiFi 2x2 BGN	N
AS8943G-434G64Mn	Middle East	LX.PU102.028	3rd WiFi 2x2 BGN	N
AS8943G-434G64Mn	Middle East	LX.PU102.027	3rd WiFi 2x2 BGN	N
AS8943G-434G64Mn	Middle East	LX.PU102.026	3rd WiFi 2x2 BGN	N
AS8943G-434G64Mn	Poland	LX.PU102.024	3rd WiFi 2x2 BGN	N
AS8943G-434G64Mn	Portugal	LX.PU102.012	3rd WiFi 2x2 BGN	N
AS8943G-434G64Mn	Serbia/Macedonia	LX.PU102.010	3rd WiFi 2x2 BGN	N
AS8943G-434G64Mn	South Africa	LX.PU102.041	3rd WiFi 2x2 BGN	N

Model	Country	Acer P/N	Wireless LAN1	Bluetooth
AS8943G-434G64Mn	South Africa	LX.PU102.030	3rd WiFi 2x2 BGN	N
AS8943G-434G64Mn	South Africa	LX.PU102.025	3rd WiFi 2x2 BGN	N
AS8943G-434G64Mn	Spain	LX.PUJ02.002	3rd WiFi 2x2 BGN	N
AS8943G-434G64Mn	Spain	LX.PU102.005	3rd WiFi 2x2 BGN	N
AS8943G-434G64Mn	Switzerland	LX.PU102.032	3rd WiFi 2x2 BGN	N
AS8943G-434G64Mn	Turkey	LX.PU102.097	3rd WiFi 2x2 BGN	BT 2.1
AS8943G-434G64Mn	Turkey	LX.PU102.040	3rd WiFi 2x2 BGN	N
AS8943G-434G64Mn	UK	LX.PU102.018	3rd WiFi 2x2 BGN	N
AS8943G-434G64Mn	Ukraine	LX.PU102.045	3rd WiFi 2x2 BGN	N
AS8943G-436G1TBi	Russia	LX.PU102.089	3rd WiFi BG	BT 2.1
AS8943G-436G1TBn	Algeria	LX.PU102.081	3rd WiFi 2x2 BGN	BT 2.1
AS8943G-436G1TBn	Austria	LX.PU102.048	3rd WiFi 2x2 BGN	BT 2.1
AS8943G-436G1TBn	Baltic	LX.PU102.072	3rd WiFi 2x2 BGN	BT 2.1
AS8943G-436G1TBn	Baltic	LX.PU102.059	3rd WiFi 2x2 BGN	BT 2.1
AS8943G-436G1TBn	Baltic	LX.PU102.056	3rd WiFi 2x2 BGN	BT 2.1
AS8943G-436G1TBn	Belgium	LX.PU102.069	3rd WiFi 2x2 BGN	BT 2.1
AS8943G-436G1TBn	Cyprus	LX.PU102.058	3rd WiFi 2x2 BGN	BT 2.1
AS8943G-436G1TBn	Czech	LX.PU102.062	3rd WiFi 2x2 BGN	BT 2.1
AS8943G-436G1TBn	Denmark	LX.PU102.054	3rd WiFi 2x2 BGN	BT 2.1
AS8943G-436G1TBn	Eastern Europe	LX.PU102.065	3rd WiFi 2x2 BGN	BT 2.1
AS8943G-436G1TBn	Eastern Europe	LX.PU102.064	3rd WiFi 2x2 BGN	BT 2.1
AS8943G-436G1TBn	Eastern Europe	LX.PU102.053	3rd WiFi 2x2 BGN	BT 2.1
AS8943G-436G1TBn	Eastern Europe	LX.PU102.052	3rd WiFi 2x2 BGN	BT 2.1
AS8943G-436G1TBn	Eastern Europe	LX.PU102.047	3rd WiFi 2x2 BGN	BT 2.1
AS8943G-436G1TBn	France	LX.PU102.046	3rd WiFi 2x2 BGN	BT 2.1

Model	Country	Acer P/N	Wireless LAN1	Bluetooth
AS8943G-436G1TBn	Germany	LX.PU102.073	3rd WiFi 2x2 BGN	BT 2.1
AS8943G-436G1TBn	Greece	LX.PU102.049	3rd WiFi 2x2 BGN	BT 2.1
AS8943G-436G1TBn	Holland	LX.PU102.070	3rd WiFi 2x2 BGN	BT 2.1
AS8943G-436G1TBn	Hungary	LX.PU102.061	3rd WiFi 2x2 BGN	BT 2.1
AS8943G-436G1TBn	Israel	LX.PU102.060	3rd WiFi 2x2 BGN	BT 2.1
AS8943G-436G1TBn	Italy	LX.PU102.051	3rd WiFi 2x2 BGN	BT 2.1
AS8943G-436G1TBn	Latvia	LX.PU102.067	3rd WiFi 2x2 BGN	BT 2.1
AS8943G-436G1TBn	Latvia	LX.PU102.066	3rd WiFi 2x2 BGN	BT 2.1
AS8943G-436G1TBn	Luxembourg	LX.PU102.071	3rd WiFi 2x2 BGN	BT 2.1
AS8943G-436G1TBn	Middle East	LX.PU102.088	3rd WiFi 2x2 BGN	BT 2.1
AS8943G-436G1TBn	Middle East	LX.PU102.087	3rd WiFi 2x2 BGN	BT 2.1
AS8943G-436G1TBn	Middle East	LX.PU102.084	3rd WiFi 2x2 BGN	BT 2.1
AS8943G-436G1TBn	Middle East	LX.PU102.083	3rd WiFi 2x2 BGN	BT 2.1
AS8943G-436G1TBn	Middle East	LX.PU102.082	3rd WiFi 2x2 BGN	BT 2.1
AS8943G-436G1TBn	Middle East	LX.PU102.079	3rd WiFi 2x2 BGN	BT 2.1
AS8943G-436G1TBn	Middle East	LX.PU102.078	3rd WiFi 2x2 BGN	BT 2.1
AS8943G-436G1TBn	Middle East	LX.PU102.077	3rd WiFi 2x2 BGN	BT 2.1
AS8943G-436G1TBn	Middle East	LX.PU102.076	3rd WiFi 2x2 BGN	BT 2.1
AS8943G-436G1TBn	Poland	LX.PU102.074	3rd WiFi 2x2 BGN	BT 2.1
AS8943G-436G1TBn	Portugal	LX.PU102.057	3rd WiFi 2x2 BGN	BT 2.1
AS8943G-436G1TBn	Serbia/Macedonia	LX.PU102.055	3rd WiFi 2x2 BGN	BT 2.1
AS8943G-436G1TBn	South Africa	LX.PU102.086	3rd WiFi 2x2 BGN	BT 2.1
AS8943G-436G1TBn	South Africa	LX.PU102.080	3rd WiFi 2x2 BGN	BT 2.1
AS8943G-436G1TBn	South Africa	LX.PU102.075	3rd WiFi 2x2 BGN	BT 2.1
AS8943G-436G1TBn	Spain	LX.PU102.050	3rd WiFi 2x2 BGN	BT 2.1

Model	Country	Acer P/N	Wireless LAN1	Bluetooth
AS8943G-436G1TBn	Switzerland	LX.PU102.068	3rd WiFi 2x2 BGN	BT 2.1
AS8943G-436G1TBn	Turkey	LX.PU102.085	3rd WiFi 2x2 BGN	BT 2.1
AS8943G-436G1TBn	UK	LX.PU102.063	3rd WiFi 2x2 BGN	BT 2.1
AS8943G-436G1TBn	Ukraine	LX.PU102.090	3rd WiFi 2x2 BGN	BT 2.1
AS8943G-436G1TWn	Turkey	LX.PU102.098	3rd WiFi 2x2 BGN	BT 2.1
AS8943G-438G1TBn	Switzerland	LX.PU102.096	3rd WiFi 2x2 BGN	BT 2.1
AS8943G-438G64Bn	Switzerland	LX.PU102.095	3rd WiFi 2x2 BGN	BT 2.1
AS8943G-524G64Mn	WW	S2.PTL02.002	INT1000H	BT 2.1
AS8943G-524G64Mn	WW	S2.PTL02.002	INT1000H	BT 2.1
AS8943G-524G64Mn	WW	S2.PTJ02.002	INT1000H	N
AS8943G-524G64Mn	WW	S2.PTJ02.002	INT1000H	N
AS8943G-526G1TWn	Turkey	LX.PU102.102	3rd WiFi 2x2 BGN	BT 2.1
AS8943G-526G64Mn	Turkey	LX.PUJ02.057	3rd WiFi 2x2 BGN	BT 2.1
AS8943G-544G1TMn	WW	S2.PUJ02.001	3rd WiFi 2x2 BGN	BT 2.1
AS8943G-544G1TMn	WW	S2.PUJ02.001	3rd WiFi 2x2 BGN	BT 2.1
AS8943G-544G64Bn	WW	S2.PTJ02.001	3rd WiFi 2x2 BGN	BT 2.1
AS8943G-544G64Bn	WW	S2.PTJ02.001	3rd WiFi 2x2 BGN	BT 2.1
AS8943G-624G1.28TBn	France	LX.PU102.093	3rd WiFi 2x2 BGN	BT 2.1
AS8943G-624G1TMn	France	LX.PU102.094	3rd WiFi 2x2 BGN	BT 2.1
AS8943G-624G64Mn	China	LX.PU202.001	3rd WiFi 2x2 BGN	BT 2.1
AS8943G-624G64Mn	Hong Kong	LX.PU102.091	3rd WiFi 2x2 BGN	BT 2.1
AS8943G-626G1TWn	Turkey	LX.PUJ02.005	3rd WiFi 2x2 BGN	BT 2.1
AS8943G-626G1TWn	Turkey	LX.PU102.101	3rd WiFi 2x2 BGN	BT 2.1
AS8943G-628G1TMn	WW	S2.PU202.001	3rd WiFi 2x2 BGN	BT 2.1
AS8943G-628G1TMn	WW	S2.PU202.001	3rd WiFi 2x2 BGN	BT 2.1

Model	Country	Acer P/N	Wireless LAN1	Bluetooth
AS8943G-72101.28TWn	Singapore	LX.PUH02.236	3rd WiFi 2x2 BGN	BT 2.1
AS8943G-72101.28TWn	Singapore	LX.PUG02.010	3rd WiFi 2x2 BGN	BT 2.1
AS8943G-72161.28TWn	Belgium	LX.PUH02.246	3rd WiFi 2x2 BGN	BT 2.1
AS8943G-72161.28TWn	Germany	LX.PUH02.188	3rd WiFi 2x2 BGN	BT 2.1
AS8943G-72161.28TWn	Holland	LX.PUH02.245	3rd WiFi 2x2 BGN	BT 2.1
AS8943G-72161.28TWn	Luxembourg	LX.PUH02.244	3rd WiFi 2x2 BGN	BT 2.1
AS8943G-72161.28TWn	Singapore	LX.PUH02.190	3rd WiFi 2x2 BGN	BT 2.1
AS8943G-72161.28TWn	Singapore	LX.PUG02.009	3rd WiFi 2x2 BGN	BT 2.1
AS8943G-72161.28TWn	Spain	LX.PUG02.003	3rd WiFi 2x2 BGN	BT 2.1
AS8943G-72161.28TWn	UK	LX.PUG02.014	3rd WiFi 2x2 BGN	BT 2.1
AS8943G-721632Wn	Poland	LX.PUH02.255	3rd WiFi 2x2 BGN	N
AS8943G-721682Bn	WW	S2.PUG02.002	INT1000H	BT 2.1
AS8943G-721682Bn	WW	S2.PUG02.002	INT1000H	BT 2.1
AS8943G-724G1TBn	Belgium	LX.PUH02.249	3rd WiFi 2x2 BGN	BT 2.1
AS8943G-724G1TBn	GCTWN	LX.PUH02.183	3rd WiFi 2x2 BGN	BT 2.1
AS8943G-724G1TBn	GCTWN	LX.PUH02.182	3rd WiFi 2x2 BGN	BT 2.1
AS8943G-724G1TBn	Germany	LX.PUH02.239	3rd WiFi 2x2 BGN	BT 2.1
AS8943G-724G1TBn	Holland	LX.PUH02.248	3rd WiFi 2x2 BGN	BT 2.1
AS8943G-724G1TBn	Hong Kong	LX.PUH02.181	3rd WiFi 2x2 BGN	BT 2.1
AS8943G-724G1TBn	Luxembourg	LX.PUH02.247	3rd WiFi 2x2 BGN	BT 2.1
AS8943G-724G1TMn	Algeria	LX.PUH02.226	3rd WiFi 2x2 BGN	BT 2.1
AS8943G-724G1TMn	Austria	LX.PUH02.193	3rd WiFi 2x2 BGN	BT 2.1
AS8943G-724G1TMn	Baltic	LX.PUH02.218	3rd WiFi 2x2 BGN	BT 2.1
AS8943G-724G1TMn	Baltic	LX.PUH02.205	3rd WiFi 2x2 BGN	BT 2.1
AS8943G-724G1TMn	Baltic	LX.PUH02.202	3rd WiFi 2x2 BGN	BT 2.1

Model	Country	Acer P/N	Wireless LAN1	Bluetooth
AS8943G-724G1TMn	Belgium	LX.PUH02.216	3rd WiFi 2x2 BGN	BT 2.1
AS8943G-724G1TMn	Cyprus	LX.PUH02.203	3rd WiFi 2x2 BGN	BT 2.1
AS8943G-724G1TMn	Czech	LX.PUH02.208	3rd WiFi 2x2 BGN	BT 2.1
AS8943G-724G1TMn	Denmark	LX.PUH02.197	3rd WiFi 2x2 BGN	BT 2.1
AS8943G-724G1TMn	Eastern Europe	LX.PUH02.210	3rd WiFi 2x2 BGN	BT 2.1
AS8943G-724G1TMn	Eastern Europe	LX.PUH02.209	3rd WiFi 2x2 BGN	BT 2.1
AS8943G-724G1TMn	Eastern Europe	LX.PUH02.196	3rd WiFi 2x2 BGN	BT 2.1
AS8943G-724G1TMn	Eastern Europe	LX.PUH02.195	3rd WiFi 2x2 BGN	BT 2.1
AS8943G-724G1TMn	Eastern Europe	LX.PUH02.191	3rd WiFi 2x2 BGN	BT 2.1
AS8943G-724G1TMn	France	LX.PUH02.192	3rd WiFi 2x2 BGN	BT 2.1
AS8943G-724G1TMn	Germany	LX.PUH02.220	3rd WiFi 2x2 BGN	BT 2.1
AS8943G-724G1TMn	Greece	LX.PUH02.194	3rd WiFi 2x2 BGN	BT 2.1
AS8943G-724G1TMn	Holland	LX.PUH02.217	3rd WiFi 2x2 BGN	BT 2.1
AS8943G-724G1TMn	Hungary	LX.PUH02.207	3rd WiFi 2x2 BGN	BT 2.1
AS8943G-724G1TMn	Israel	LX.PUH02.206	3rd WiFi 2x2 BGN	BT 2.1
AS8943G-724G1TMn	Italy	LX.PUH02.199	3rd WiFi 2x2 BGN	BT 2.1
AS8943G-724G1TMn	Latvia	LX.PUH02.213	3rd WiFi 2x2 BGN	BT 2.1
AS8943G-724G1TMn	Latvia	LX.PUH02.212	3rd WiFi 2x2 BGN	BT 2.1
AS8943G-724G1TMn	Luxembourg	LX.PUH02.214	3rd WiFi 2x2 BGN	BT 2.1
AS8943G-724G1TMn	Middle East	LX.PUH02.235	3rd WiFi 2x2 BGN	BT 2.1
AS8943G-724G1TMn	Middle East	LX.PUH02.234	3rd WiFi 2x2 BGN	BT 2.1
AS8943G-724G1TMn	Middle East	LX.PUH02.231	3rd WiFi 2x2 BGN	BT 2.1
AS8943G-724G1TMn	Middle East	LX.PUH02.230	3rd WiFi 2x2 BGN	BT 2.1
AS8943G-724G1TMn	Middle East	LX.PUH02.228	3rd WiFi 2x2 BGN	BT 2.1
AS8943G-724G1TMn	Middle East	LX.PUH02.227	3rd WiFi 2x2 BGN	BT 2.1

Model	Country	Acer P/N	Wireless LAN1	Bluetooth
AS8943G-724G1TMn	Middle East	LX.PUH02.224	3rd WiFi 2x2 BGN	BT 2.1
AS8943G-724G1TMn	Middle East	LX.PUH02.223	3rd WiFi 2x2 BGN	BT 2.1
AS8943G-724G1TMn	Middle East	LX.PUH02.222	3rd WiFi 2x2 BGN	BT 2.1
AS8943G-724G1TMn	Poland	LX.PUH02.219	3rd WiFi 2x2 BGN	BT 2.1
AS8943G-724G1TMn	Portugal	LX.PUH02.204	3rd WiFi 2x2 BGN	BT 2.1
AS8943G-724G1TMn	Serbia/Macedonia	LX.PUH02.201	3rd WiFi 2x2 BGN	BT 2.1
AS8943G-724G1TMn	South Africa	LX.PUH02.233	3rd WiFi 2x2 BGN	BT 2.1
AS8943G-724G1TMn	South Africa	LX.PUH02.229	3rd WiFi 2x2 BGN	BT 2.1
AS8943G-724G1TMn	South Africa	LX.PUH02.225	3rd WiFi 2x2 BGN	BT 2.1
AS8943G-724G1TMn	South Africa	LX.PUH02.221	3rd WiFi 2x2 BGN	BT 2.1
AS8943G-724G1TMn	Spain	LX.PUH02.198	3rd WiFi 2x2 BGN	BT 2.1
AS8943G-724G1TMn	Switzerland	LX.PUH02.215	3rd WiFi 2x2 BGN	BT 2.1
AS8943G-724G1TMn	Turkey	LX.PUH02.232	3rd WiFi 2x2 BGN	BT 2.1
AS8943G-724G1TMn	UK	LX.PUH02.211	3rd WiFi 2x2 BGN	BT 2.1
AS8943G-724G1TWn	Hong Kong	LX.PUH02.238	3rd WiFi 2x2 BGN	BT 2.1
AS8943G-724G50Bn	USA	LX.PWC02.074	3rd WiFi 2x2 BGN	BT 2.1
AS8943G-724G50Mn	USA	LX.PWC02.070	3rd WiFi 2x2 BGN	N
AS8943G-724G64Bn	Middle East	LX.PWC02.069	3rd WiFi 2x2 BGN	BT 2.1
AS8943G-724G64Bn	UK	LX.PWC02.076	3rd WiFi 2x2 BGN	BT 2.1
AS8943G-724G64Mi	Russia	LX.PWC02.066	3rd WiFi BG	BT 2.1
AS8943G-724G64Mi	Russia	LX.PUH02.045	3rd WiFi BG	BT 2.1
AS8943G-724G64Mn	Algeria	LX.PWC02.047	3rd WiFi 2x2 BGN	BT 2.1
AS8943G-724G64Mn	Algeria	LX.PUH02.037	3rd WiFi 2x2 BGN	BT 2.1
AS8943G-724G64Mn	Austria	LX.PWC02.005	3rd WiFi 2x2 BGN	BT 2.1
AS8943G-724G64Mn	Austria	LX.PUH02.009	3rd WiFi 2x2 BGN	BT 2.1

Model	Country	Acer P/N	Wireless LAN1	Bluetooth
AS8943G-724G64Mn	Baltic	LX.PWC02.058	3rd WiFi 2x2 BGN	BT 2.1
AS8943G-724G64Mn	Baltic	LX.PWC02.027	3rd WiFi 2x2 BGN	BT 2.1
AS8943G-724G64Mn	Baltic	LX.PWC02.024	3rd WiFi 2x2 BGN	BT 2.1
AS8943G-724G64Mn	Baltic	LX.PUH02.028	3rd WiFi 2x2 BGN	BT 2.1
AS8943G-724G64Mn	Baltic	LX.PUH02.020	3rd WiFi 2x2 BGN	BT 2.1
AS8943G-724G64Mn	Baltic	LX.PUH02.017	3rd WiFi 2x2 BGN	BT 2.1
AS8943G-724G64Mn	Belgium	LX.PWC02.055	3rd WiFi 2x2 BGN	BT 2.1
AS8943G-724G64Mn	Belgium	LX.PUH02.025	3rd WiFi 2x2 BGN	BT 2.1
AS8943G-724G64Mn	China	LX.PUH02.001	3rd WiFi 2x2 BGN	BT 2.1
AS8943G-724G64Mn	Cyprus	LX.PWC02.025	3rd WiFi 2x2 BGN	BT 2.1
AS8943G-724G64Mn	Cyprus	LX.PUH02.019	3rd WiFi 2x2 BGN	BT 2.1
AS8943G-724G64Mn	Czech	LX.PWC02.030	3rd WiFi 2x2 BGN	BT 2.1
AS8943G-724G64Mn	Czech	LX.PUH02.004	3rd WiFi 2x2 BGN	BT 2.1
AS8943G-724G64Mn	Denmark	LX.PWC02.012	3rd WiFi 2x2 BGN	BT 2.1
AS8943G-724G64Mn	Denmark	LX.PUH02.015	3rd WiFi 2x2 BGN	BT 2.1
AS8943G-724G64Mn	Eastern Europe	LX.PWC02.040	3rd WiFi 2x2 BGN	BT 2.1
AS8943G-724G64Mn	Eastern Europe	LX.PWC02.037	3rd WiFi 2x2 BGN	BT 2.1
AS8943G-724G64Mn	Eastern Europe	LX.PWC02.011	3rd WiFi 2x2 BGN	BT 2.1
AS8943G-724G64Mn	Eastern Europe	LX.PWC02.008	3rd WiFi 2x2 BGN	BT 2.1
AS8943G-724G64Mn	Eastern Europe	LX.PWC02.001	3rd WiFi 2x2 BGN	BT 2.1
AS8943G-724G64Mn	Eastern Europe	LX.PUH02.021	3rd WiFi 2x2 BGN	BT 2.1
AS8943G-724G64Mn	Eastern Europe	LX.PUH02.014	3rd WiFi 2x2 BGN	BT 2.1
AS8943G-724G64Mn	Eastern Europe	LX.PUH02.013	3rd WiFi 2x2 BGN	BT 2.1
AS8943G-724G64Mn	Eastern Europe	LX.PUH02.008	3rd WiFi 2x2 BGN	BT 2.1
AS8943G-724G64Mn	Eastern Europe	LX.PUH02.006	3rd WiFi 2x2 BGN	BT 2.1

Model	Country	Acer P/N	Wireless LAN1	Bluetooth
AS8943G-724G64Mn	France	LX.PWC02.004	3rd WiFi 2x2 BGN	BT 2.1
AS8943G-724G64Mn	France	LX.PUH02.007	3rd WiFi 2x2 BGN	BT 2.1
AS8943G-724G64Mn	Germany	LX.PWC02.061	3rd WiFi 2x2 BGN	BT 2.1
AS8943G-724G64Mn	Germany	LX.PUH02.029	3rd WiFi 2x2 BGN	BT 2.1
AS8943G-724G64Mn	Greece	LX.PWC02.007	3rd WiFi 2x2 BGN	BT 2.1
AS8943G-724G64Mn	Greece	LX.PUH02.010	3rd WiFi 2x2 BGN	BT 2.1
AS8943G-724G64Mn	Holland	LX.PWC02.056	3rd WiFi 2x2 BGN	BT 2.1
AS8943G-724G64Mn	Holland	LX.PUH02.026	3rd WiFi 2x2 BGN	BT 2.1
AS8943G-724G64Mn	Hungary	LX.PWC02.029	3rd WiFi 2x2 BGN	BT 2.1
AS8943G-724G64Mn	Hungary	LX.PUH02.003	3rd WiFi 2x2 BGN	BT 2.1
AS8943G-724G64Mn	Israel	LX.PWC02.028	3rd WiFi 2x2 BGN	BT 2.1
AS8943G-724G64Mn	Israel	LX.PUH02.002	3rd WiFi 2x2 BGN	BT 2.1
AS8943G-724G64Mn	Italy	LX.PWC02.018	3rd WiFi 2x2 BGN	BT 2.1
AS8943G-724G64Mn	Italy	LX.PUH02.012	3rd WiFi 2x2 BGN	BT 2.1
AS8943G-724G64Mn	Latvia	LX.PWC02.043	3rd WiFi 2x2 BGN	BT 2.1
AS8943G-724G64Mn	Latvia	LX.PWC02.042	3rd WiFi 2x2 BGN	BT 2.1
AS8943G-724G64Mn	Latvia	LX.PUH02.023	3rd WiFi 2x2 BGN	BT 2.1
AS8943G-724G64Mn	Latvia	LX.PUH02.022	3rd WiFi 2x2 BGN	BT 2.1
AS8943G-724G64Mn	Luxembourg	LX.PWC02.044	3rd WiFi 2x2 BGN	BT 2.1
AS8943G-724G64Mn	Luxembourg	LX.PUH02.027	3rd WiFi 2x2 BGN	BT 2.1
AS8943G-724G64Mn	Middle East	LX.PWC02.065	3rd WiFi 2x2 BGN	BT 2.1
AS8943G-724G64Mn	Middle East	LX.PWC02.064	3rd WiFi 2x2 BGN	BT 2.1
AS8943G-724G64Mn	Middle East	LX.PWC02.051	3rd WiFi 2x2 BGN	BT 2.1
AS8943G-724G64Mn	Middle East	LX.PWC02.050	3rd WiFi 2x2 BGN	BT 2.1
AS8943G-724G64Mn	Middle East	LX.PWC02.048	3rd WiFi 2x2 BGN	BT 2.1

Model	Country	Acer P/N	Wireless LAN1	Bluetooth
AS8943G-724G64Mn	Middle East	LX.PWC02.035	3rd WiFi 2x2 BGN	BT 2.1
AS8943G-724G64Mn	Middle East	LX.PWC02.034	3rd WiFi 2x2 BGN	BT 2.1
AS8943G-724G64Mn	Middle East	LX.PWC02.033	3rd WiFi 2x2 BGN	BT 2.1
AS8943G-724G64Mn	Middle East	LX.PWC02.032	3rd WiFi 2x2 BGN	BT 2.1
AS8943G-724G64Mn	Middle East	LX.PUH02.044	3rd WiFi 2x2 BGN	BT 2.1
AS8943G-724G64Mn	Middle East	LX.PUH02.043	3rd WiFi 2x2 BGN	BT 2.1
AS8943G-724G64Mn	Middle East	LX.PUH02.040	3rd WiFi 2x2 BGN	BT 2.1
AS8943G-724G64Mn	Middle East	LX.PUH02.039	3rd WiFi 2x2 BGN	BT 2.1
AS8943G-724G64Mn	Middle East	LX.PUH02.038	3rd WiFi 2x2 BGN	BT 2.1
AS8943G-724G64Mn	Middle East	LX.PUH02.035	3rd WiFi 2x2 BGN	BT 2.1
AS8943G-724G64Mn	Middle East	LX.PUH02.034	3rd WiFi 2x2 BGN	BT 2.1
AS8943G-724G64Mn	Middle East	LX.PUH02.033	3rd WiFi 2x2 BGN	BT 2.1
AS8943G-724G64Mn	Middle East	LX.PUH02.032	3rd WiFi 2x2 BGN	BT 2.1
AS8943G-724G64Mn	Poland	LX.PWC02.059	3rd WiFi 2x2 BGN	BT 2.1
AS8943G-724G64Mn	Poland	LX.PUH02.030	3rd WiFi 2x2 BGN	BT 2.1
AS8943G-724G64Mn	Portugal	LX.PWC02.026	3rd WiFi 2x2 BGN	BT 2.1
AS8943G-724G64Mn	Portugal	LX.PUH02.018	3rd WiFi 2x2 BGN	BT 2.1
AS8943G-724G64Mn	Serbia/Macedonia	LX.PWC02.019	3rd WiFi 2x2 BGN	BT 2.1
AS8943G-724G64Mn	Serbia/Macedonia	LX.PUH02.016	3rd WiFi 2x2 BGN	BT 2.1
AS8943G-724G64Mn	South Africa	LX.PWC02.063	3rd WiFi 2x2 BGN	BT 2.1
AS8943G-724G64Mn	South Africa	LX.PWC02.049	3rd WiFi 2x2 BGN	BT 2.1
AS8943G-724G64Mn	South Africa	LX.PWC02.046	3rd WiFi 2x2 BGN	BT 2.1
AS8943G-724G64Mn	South Africa	LX.PWC02.031	3rd WiFi 2x2 BGN	BT 2.1
AS8943G-724G64Mn	South Africa	LX.PUH02.042	3rd WiFi 2x2 BGN	BT 2.1
AS8943G-724G64Mn	South Africa	LX.PUH02.036	3rd WiFi 2x2 BGN	BT 2.1

Model	Country	Acer P/N	Wireless LAN1	Bluetooth
AS8943G-724G64Mn	South Africa	LX.PUH02.031	3rd WiFi 2x2 BGN	BT 2.1
AS8943G-724G64Mn	Spain	LX.PWC02.015	3rd WiFi 2x2 BGN	BT 2.1
AS8943G-724G64Mn	Spain	LX.PUH02.011	3rd WiFi 2x2 BGN	BT 2.1
AS8943G-724G64Mn	Switzerland	LX.PWC02.045	3rd WiFi 2x2 BGN	BT 2.1
AS8943G-724G64Mn	Switzerland	LX.PUH02.024	3rd WiFi 2x2 BGN	BT 2.1
AS8943G-724G64Mn	Turkey	LX.PWC02.062	3rd WiFi 2x2 BGN	BT 2.1
AS8943G-724G64Mn	Turkey	LX.PUH02.041	3rd WiFi 2x2 BGN	BT 2.1
AS8943G-724G64Mn	UK	LX.PWC02.041	3rd WiFi 2x2 BGN	BT 2.1
AS8943G-724G64Mn	UK	LX.PUH02.005	3rd WiFi 2x2 BGN	BT 2.1
AS8943G-724G64Mn	Ukraine	LX.PWC02.067	3rd WiFi 2x2 BGN	BT 2.1
AS8943G-724G64Mn	Ukraine	LX.PUH02.046	3rd WiFi 2x2 BGN	BT 2.1
AS8943G-724G64Wn	China	LX.PUH02.237	3rd WiFi 2x2 BGN	BT 2.1
AS8943G-724G64Wn	Middle East	LX.PWC02.068	3rd WiFi 2x2 BGN	BT 2.1
AS8943G-726G1.28TBn	Belgium	LX.PWC02.071	3rd WiFi 2x2 BGN	BT 2.1
AS8943G-726G1.28TBn	Belgium	LX.PUH02.241	3rd WiFi 2x2 BGN	BT 2.1
AS8943G-726G1.28TBn	Holland	LX.PWC02.073	3rd WiFi 2x2 BGN	BT 2.1
AS8943G-726G1.28TBn	Holland	LX.PUH02.240	3rd WiFi 2x2 BGN	BT 2.1
AS8943G-726G1.28TBn	Luxembourg	LX.PWC02.072	3rd WiFi 2x2 BGN	BT 2.1
AS8943G-726G1.28TBn	Luxembourg	LX.PUH02.242	3rd WiFi 2x2 BGN	BT 2.1
AS8943G-726G64Wn	Australia/New Zealand	LX.PUG02.006	3rd WiFi 2x2 BGN	BT 2.1
AS8943G-728G1.14TBn	Spain	LX.PUG02.001	3rd WiFi 2x2 BGN	BT 2.1
AS8943G-728G1.28TBn	Algeria	LX.PUH02.173	3rd WiFi 2x2 BGN	BT 2.1
AS8943G-728G1.28TBn	Austria	LX.PUH02.140	3rd WiFi 2x2 BGN	BT 2.1
AS8943G-728G1.28TBn	Baltic	LX.PUH02.164	3rd WiFi 2x2 BGN	BT 2.1
AS8943G-728G1.28TBn	Baltic	LX.PUH02.151	3rd WiFi 2x2 BGN	BT 2.1

Model	Country	Acer P/N	Wireless LAN1	Bluetooth
AS8943G-728G1.28TBn	Baltic	LX.PUH02.148	3rd WiFi 2x2 BGN	BT 2.1
AS8943G-728G1.28TBn	Belgium	LX.PUH02.161	3rd WiFi 2x2 BGN	BT 2.1
AS8943G-728G1.28TBn	Cyprus	LX.PUH02.150	3rd WiFi 2x2 BGN	BT 2.1
AS8943G-728G1.28TBn	Czech	LX.PUH02.154	3rd WiFi 2x2 BGN	BT 2.1
AS8943G-728G1.28TBn	Denmark	LX.PUH02.146	3rd WiFi 2x2 BGN	BT 2.1
AS8943G-728G1.28TBn	Eastern Europe	LX.PUH02.157	3rd WiFi 2x2 BGN	BT 2.1
AS8943G-728G1.28TBn	Eastern Europe	LX.PUH02.156	3rd WiFi 2x2 BGN	BT 2.1
AS8943G-728G1.28TBn	Eastern Europe	LX.PUH02.145	3rd WiFi 2x2 BGN	BT 2.1
AS8943G-728G1.28TBn	Eastern Europe	LX.PUH02.144	3rd WiFi 2x2 BGN	BT 2.1
AS8943G-728G1.28TBn	Eastern Europe	LX.PUH02.139	3rd WiFi 2x2 BGN	BT 2.1
AS8943G-728G1.28TBn	France	LX.PUH02.138	3rd WiFi 2x2 BGN	BT 2.1
AS8943G-728G1.28TBn	Germany	LX.PUH02.165	3rd WiFi 2x2 BGN	BT 2.1
AS8943G-728G1.28TBn	Greece	LX.PUH02.141	3rd WiFi 2x2 BGN	BT 2.1
AS8943G-728G1.28TBn	Holland	LX.PUH02.162	3rd WiFi 2x2 BGN	BT 2.1
AS8943G-728G1.28TBn	Hungary	LX.PUH02.153	3rd WiFi 2x2 BGN	BT 2.1
AS8943G-728G1.28TBn	Israel	LX.PUH02.152	3rd WiFi 2x2 BGN	BT 2.1
AS8943G-728G1.28TBn	Italy	LX.PUH02.143	3rd WiFi 2x2 BGN	BT 2.1
AS8943G-728G1.28TBn	Latvia	LX.PUH02.159	3rd WiFi 2x2 BGN	BT 2.1
AS8943G-728G1.28TBn	Latvia	LX.PUH02.158	3rd WiFi 2x2 BGN	BT 2.1
AS8943G-728G1.28TBn	Luxembourg	LX.PUH02.163	3rd WiFi 2x2 BGN	BT 2.1
AS8943G-728G1.28TBn	Middle East	LX.PUH02.180	3rd WiFi 2x2 BGN	BT 2.1
AS8943G-728G1.28TBn	Middle East	LX.PUH02.179	3rd WiFi 2x2 BGN	BT 2.1
AS8943G-728G1.28TBn	Middle East	LX.PUH02.176	3rd WiFi 2x2 BGN	BT 2.1
AS8943G-728G1.28TBn	Middle East	LX.PUH02.175	3rd WiFi 2x2 BGN	BT 2.1
AS8943G-728G1.28TBn	Middle East	LX.PUH02.174	3rd WiFi 2x2 BGN	BT 2.1

Model	Country	Acer P/N	Wireless LAN1	Bluetooth
AS8943G-728G1.28TBn	Middle East	LX.PUH02.171	3rd WiFi 2x2 BGN	BT 2.1
AS8943G-728G1.28TBn	Middle East	LX.PUH02.170	3rd WiFi 2x2 BGN	BT 2.1
AS8943G-728G1.28TBn	Middle East	LX.PUH02.169	3rd WiFi 2x2 BGN	BT 2.1
AS8943G-728G1.28TBn	Middle East	LX.PUH02.168	3rd WiFi 2x2 BGN	BT 2.1
AS8943G-728G1.28TBn	Poland	LX.PUH02.166	3rd WiFi 2x2 BGN	BT 2.1
AS8943G-728G1.28TBn	Portugal	LX.PUH02.149	3rd WiFi 2x2 BGN	BT 2.1
AS8943G-728G1.28TBn	Serbia/Macedonia	LX.PUH02.147	3rd WiFi 2x2 BGN	BT 2.1
AS8943G-728G1.28TBn	South Africa	LX.PUH02.178	3rd WiFi 2x2 BGN	BT 2.1
AS8943G-728G1.28TBn	South Africa	LX.PUH02.172	3rd WiFi 2x2 BGN	BT 2.1
AS8943G-728G1.28TBn	South Africa	LX.PUH02.167	3rd WiFi 2x2 BGN	BT 2.1
AS8943G-728G1.28TBn	Spain	LX.PUH02.142	3rd WiFi 2x2 BGN	BT 2.1
AS8943G-728G1.28TBn	Switzerland	LX.PUH02.160	3rd WiFi 2x2 BGN	BT 2.1
AS8943G-728G1.28TBn	Turkey	LX.PUH02.177	3rd WiFi 2x2 BGN	BT 2.1
AS8943G-728G1.28TBn	UK	LX.PUH02.155	3rd WiFi 2x2 BGN	BT 2.1
AS8943G-728G1.28TWi	Russia	LX.PUH02.254	3rd WiFi BG	BT 2.1
AS8943G-728G1.28TWn	Australia/New Zealand	LX.PUG02.007	3rd WiFi 2x2 BGN	BT 2.1
AS8943G-728G1.28TWn	Czech	LX.PUG02.011	3rd WiFi 2x2 BGN	BT 2.1
AS8943G-728G1.28TWn	France	LX.PUG02.004	3rd WiFi 2x2 BGN	BT 2.1
AS8943G-728G1.28TWn	Germany	LX.PUH02.251	3rd WiFi 2x2 BGN	BT 2.1
AS8943G-728G1.28TWn	Philippines	LX.PUH02.250	3rd WiFi 2x2 BGN	BT 2.1
AS8943G-728G1.28TWn	Singapore	LX.PUH02.189	3rd WiFi 2x2 BGN	BT 2.1
AS8943G-728G1.28TWn	Singapore	LX.PUG02.008	3rd WiFi 2x2 BGN	BT 2.1
AS8943G-728G1.28TWn	Switzerland	LX.PUH02.185	3rd WiFi 2x2 BGN	BT 2.1
AS8943G-728G1.28TWn	Switzerland	LX.PUH02.184	3rd WiFi 2x2 BGN	BT 2.1
AS8943G-728G1.28TWn	Switzerland	LX.PUG02.005	3rd WiFi 2x2 BGN	BT 2.1

Model	Country	Acer P/N	Wireless LAN1	Bluetooth
AS8943G-728G1.28TWn	Thailand	LX.PUH02.253	3rd WiFi 2x2 BGN	BT 2.1
AS8943G-728G1.28TWn	Thailand	LX.PUH02.252	3rd WiFi 2x2 BGN	BT 2.1
AS8943G-728G1TBi	Russia	LX.PUH02.136	3rd WiFi BG	BT 2.1
AS8943G-728G1TBn	Algeria	LX.PUH02.128	3rd WiFi 2x2 BGN	BT 2.1
AS8943G-728G1TBn	Austria	LX.PUH02.094	3rd WiFi 2x2 BGN	BT 2.1
AS8943G-728G1TBn	Baltic	LX.PUH02.119	3rd WiFi 2x2 BGN	BT 2.1
AS8943G-728G1TBn	Baltic	LX.PUH02.102	3rd WiFi 2x2 BGN	BT 2.1
AS8943G-728G1TBn	Baltic	LX.PUH02.098	3rd WiFi 2x2 BGN	BT 2.1
AS8943G-728G1TBn	Belgium	LX.PUH02.116	3rd WiFi 2x2 BGN	BT 2.1
AS8943G-728G1TBn	Cyprus	LX.PUH02.101	3rd WiFi 2x2 BGN	BT 2.1
AS8943G-728G1TBn	Czech	LX.PUH02.105	3rd WiFi 2x2 BGN	BT 2.1
AS8943G-728G1TBn	Denmark	LX.PUH02.096	3rd WiFi 2x2 BGN	BT 2.1
AS8943G-728G1TBn	Eastern Europe	LX.PUH02.112	3rd WiFi 2x2 BGN	BT 2.1
AS8943G-728G1TBn	Eastern Europe	LX.PUH02.111	3rd WiFi 2x2 BGN	BT 2.1
AS8943G-728G1TBn	Eastern Europe	LX.PUH02.110	3rd WiFi 2x2 BGN	BT 2.1
AS8943G-728G1TBn	Eastern Europe	LX.PUH02.107	3rd WiFi 2x2 BGN	BT 2.1
AS8943G-728G1TBn	Eastern Europe	LX.PUH02.093	3rd WiFi 2x2 BGN	BT 2.1
AS8943G-728G1TBn	France	LX.PUH02.092	3rd WiFi 2x2 BGN	BT 2.1
AS8943G-728G1TBn	Germany	LX.PUH02.120	3rd WiFi 2x2 BGN	BT 2.1
AS8943G-728G1TBn	Greece	LX.PUH02.095	3rd WiFi 2x2 BGN	BT 2.1
AS8943G-728G1TBn	Holland	LX.PUH02.117	3rd WiFi 2x2 BGN	BT 2.1
AS8943G-728G1TBn	Hungary	LX.PUH02.104	3rd WiFi 2x2 BGN	BT 2.1
AS8943G-728G1TBn	Israel	LX.PUH02.103	3rd WiFi 2x2 BGN	BT 2.1
AS8943G-728G1TBn	Italy	LX.PUH02.109	3rd WiFi 2x2 BGN	BT 2.1
AS8943G-728G1TBn	Latvia	LX.PUH02.114	3rd WiFi 2x2 BGN	BT 2.1

Model	Country	Acer P/N	Wireless LAN1	Bluetooth
AS8943G-728G1TBn	Latvia	LX.PUH02.113	3rd WiFi 2x2 BGN	BT 2.1
AS8943G-728G1TBn	Luxembourg	LX.PUH02.118	3rd WiFi 2x2 BGN	BT 2.1
AS8943G-728G1TBn	Middle East	LX.PUH02.135	3rd WiFi 2x2 BGN	BT 2.1
AS8943G-728G1TBn	Middle East	LX.PUH02.134	3rd WiFi 2x2 BGN	BT 2.1
AS8943G-728G1TBn	Middle East	LX.PUH02.131	3rd WiFi 2x2 BGN	BT 2.1
AS8943G-728G1TBn	Middle East	LX.PUH02.130	3rd WiFi 2x2 BGN	BT 2.1
AS8943G-728G1TBn	Middle East	LX.PUH02.129	3rd WiFi 2x2 BGN	BT 2.1
AS8943G-728G1TBn	Middle East	LX.PUH02.126	3rd WiFi 2x2 BGN	BT 2.1
AS8943G-728G1TBn	Middle East	LX.PUH02.125	3rd WiFi 2x2 BGN	BT 2.1
AS8943G-728G1TBn	Middle East	LX.PUH02.124	3rd WiFi 2x2 BGN	BT 2.1
AS8943G-728G1TBn	Middle East	LX.PUH02.123	3rd WiFi 2x2 BGN	BT 2.1
AS8943G-728G1TBn	Poland	LX.PUH02.121	3rd WiFi 2x2 BGN	BT 2.1
AS8943G-728G1TBn	Portugal	LX.PUH02.099	3rd WiFi 2x2 BGN	BT 2.1
AS8943G-728G1TBn	Serbia/Macedonia	LX.PUH02.097	3rd WiFi 2x2 BGN	BT 2.1
AS8943G-728G1TBn	South Africa	LX.PUH02.133	3rd WiFi 2x2 BGN	BT 2.1
AS8943G-728G1TBn	South Africa	LX.PUH02.127	3rd WiFi 2x2 BGN	BT 2.1
AS8943G-728G1TBn	South Africa	LX.PUH02.122	3rd WiFi 2x2 BGN	BT 2.1
AS8943G-728G1TBn	Spain	LX.PUH02.108	3rd WiFi 2x2 BGN	BT 2.1
AS8943G-728G1TBn	Spain	LX.PUG02.002	3rd WiFi 2x2 BGN	BT 2.1
AS8943G-728G1TBn	Switzerland	LX.PUH02.186	3rd WiFi 2x2 BGN	BT 2.1
AS8943G-728G1TBn	Switzerland	LX.PUH02.115	3rd WiFi 2x2 BGN	BT 2.1
AS8943G-728G1TBn	Turkey	LX.PUH02.132	3rd WiFi 2x2 BGN	BT 2.1
AS8943G-728G1TBn	UK	LX.PUH02.106	3rd WiFi 2x2 BGN	BT 2.1
AS8943G-728G1TBn	Ukraine	LX.PUH02.137	3rd WiFi 2x2 BGN	BT 2.1
AS8943G-728G1TMn	GCTWN	S2.PUG02.001	3rd WiFi 2x2 BGN	BT 2.1

Model	Country	Acer P/N	Wireless LAN1	Bluetooth
AS8943G-728G1TMn	GCTWN	S2.PUG02.001	3rd WiFi 2x2 BGN	BT 2.1
AS8943G-728G1TMn	WW	S2.PUH02.001	3rd WiFi 2x2 BGN	BT 2.1
AS8943G-728G1TMn	WW	S2.PUH02.001	3rd WiFi 2x2 BGN	BT 2.1
AS8943G-728G1TWi	Russia	LX.PUH02.187	3rd WiFi BG	BT 2.1
AS8943G-728G1TWn	UK	LX.PUG02.013	3rd WiFi 2x2 BGN	BT 2.1
AS8943G-728G64Bi	Russia	LX.PUH02.090	3rd WiFi BG	BT 2.1
AS8943G-728G64Bn	Algeria	LX.PUH02.082	3rd WiFi 2x2 BGN	BT 2.1
AS8943G-728G64Bn	Austria	LX.PUH02.049	3rd WiFi 2x2 BGN	BT 2.1
AS8943G-728G64Bn	Baltic	LX.PUH02.073	3rd WiFi 2x2 BGN	BT 2.1
AS8943G-728G64Bn	Baltic	LX.PUH02.060	3rd WiFi 2x2 BGN	BT 2.1
AS8943G-728G64Bn	Baltic	LX.PUH02.057	3rd WiFi 2x2 BGN	BT 2.1
AS8943G-728G64Bn	Belgium	LX.PUH02.070	3rd WiFi 2x2 BGN	BT 2.1
AS8943G-728G64Bn	Cyprus	LX.PUH02.059	3rd WiFi 2x2 BGN	BT 2.1
AS8943G-728G64Bn	Czech	LX.PUH02.063	3rd WiFi 2x2 BGN	BT 2.1
AS8943G-728G64Bn	Denmark	LX.PUH02.055	3rd WiFi 2x2 BGN	BT 2.1
AS8943G-728G64Bn	Eastern Europe	LX.PUH02.066	3rd WiFi 2x2 BGN	BT 2.1
AS8943G-728G64Bn	Eastern Europe	LX.PUH02.065	3rd WiFi 2x2 BGN	BT 2.1
AS8943G-728G64Bn	Eastern Europe	LX.PUH02.054	3rd WiFi 2x2 BGN	BT 2.1
AS8943G-728G64Bn	Eastern Europe	LX.PUH02.053	3rd WiFi 2x2 BGN	BT 2.1
AS8943G-728G64Bn	Eastern Europe	LX.PUH02.048	3rd WiFi 2x2 BGN	BT 2.1
AS8943G-728G64Bn	France	LX.PUH02.047	3rd WiFi 2x2 BGN	BT 2.1
AS8943G-728G64Bn	Germany	LX.PUH02.074	3rd WiFi 2x2 BGN	BT 2.1
AS8943G-728G64Bn	Greece	LX.PUH02.050	3rd WiFi 2x2 BGN	BT 2.1
AS8943G-728G64Bn	Holland	LX.PUH02.071	3rd WiFi 2x2 BGN	BT 2.1
AS8943G-728G64Bn	Hungary	LX.PUH02.062	3rd WiFi 2x2 BGN	BT 2.1

Model	Country	Acer P/N	Wireless LAN1	Bluetooth
AS8943G-728G64Bn	Israel	LX.PUH02.061	3rd WiFi 2x2 BGN	BT 2.1
AS8943G-728G64Bn	Italy	LX.PUH02.052	3rd WiFi 2x2 BGN	BT 2.1
AS8943G-728G64Bn	Latvia	LX.PUH02.068	3rd WiFi 2x2 BGN	BT 2.1
AS8943G-728G64Bn	Latvia	LX.PUH02.067	3rd WiFi 2x2 BGN	BT 2.1
AS8943G-728G64Bn	Luxembourg	LX.PUH02.072	3rd WiFi 2x2 BGN	BT 2.1
AS8943G-728G64Bn	Middle East	LX.PUH02.089	3rd WiFi 2x2 BGN	BT 2.1
AS8943G-728G64Bn	Middle East	LX.PUH02.088	3rd WiFi 2x2 BGN	BT 2.1
AS8943G-728G64Bn	Middle East	LX.PUH02.085	3rd WiFi 2x2 BGN	BT 2.1
AS8943G-728G64Bn	Middle East	LX.PUH02.084	3rd WiFi 2x2 BGN	BT 2.1
AS8943G-728G64Bn	Middle East	LX.PUH02.083	3rd WiFi 2x2 BGN	BT 2.1
AS8943G-728G64Bn	Middle East	LX.PUH02.080	3rd WiFi 2x2 BGN	BT 2.1
AS8943G-728G64Bn	Middle East	LX.PUH02.079	3rd WiFi 2x2 BGN	BT 2.1
AS8943G-728G64Bn	Middle East	LX.PUH02.078	3rd WiFi 2x2 BGN	BT 2.1
AS8943G-728G64Bn	Middle East	LX.PUH02.077	3rd WiFi 2x2 BGN	BT 2.1
AS8943G-728G64Bn	Poland	LX.PUH02.075	3rd WiFi 2x2 BGN	BT 2.1
AS8943G-728G64Bn	Portugal	LX.PUH02.058	3rd WiFi 2x2 BGN	BT 2.1
AS8943G-728G64Bn	Serbia/Macedonia	LX.PUH02.056	3rd WiFi 2x2 BGN	BT 2.1
AS8943G-728G64Bn	South Africa	LX.PUH02.087	3rd WiFi 2x2 BGN	BT 2.1
AS8943G-728G64Bn	South Africa	LX.PUH02.081	3rd WiFi 2x2 BGN	BT 2.1
AS8943G-728G64Bn	South Africa	LX.PUH02.076	3rd WiFi 2x2 BGN	BT 2.1
AS8943G-728G64Bn	Spain	LX.PUH02.051	3rd WiFi 2x2 BGN	BT 2.1
AS8943G-728G64Bn	Switzerland	LX.PUH02.069	3rd WiFi 2x2 BGN	BT 2.1
AS8943G-728G64Bn	Turkey	LX.PUH02.086	3rd WiFi 2x2 BGN	BT 2.1
AS8943G-728G64Bn	UK	LX.PUH02.064	3rd WiFi 2x2 BGN	BT 2.1
AS8943G-728G64Bn	Ukraine	LX.PUH02.091	3rd WiFi 2x2 BGN	BT 2.1

Model	Country	Acer P/N	Wireless LAN1	Bluetooth
AS8943G-82121.28TBn	WW	S2.PWC02.007	3rd WiFi 2x2 BGN	BT 2.1
AS8943G-82121.28TBn	WW	S2.PWC02.007	3rd WiFi 2x2 BGN	BT 2.1
AS8943G-82161.28TWn	UK	LX.PWC02.075	3rd WiFi 2x2 BGN	BT 2.1
AS8943G-82161.28TWn	WW	S2.PU102.001	3rd WiFi 2x2 BGN	BT 2.1
AS8943G-82161.28TWn	WW	S2.PU102.001	3rd WiFi 2x2 BGN	BT 2.1
AS8943G-828G1.28TMn	Philippines	LX.PUH02.243	3rd WiFi 2x2 BGN	BT 2.1

Test Compatible Components

This computer's compatibility is tested and verified by Acer's internal testing department. All of its system functions are tested under Windows® 7 environment.

Refer to the following lists for components, adapter cards, and peripherals which have passed these tests. Regarding configuration, combination and test procedures, please refer to the Compatibility Test Report released by the Acer Mobile System Testing Department.

Vendor	Type	Description	P/N
2nd HDD			
HGST	N160GB5.4KS	HDD HGST 2.5" 5400rpm 160GB HTS545016B9A300 Panther B SATA LF F/ W:C60F Disk imbalance criteria = 0.014g-cm	KH.16007.026
HGST	N250GB5.4KS	HDD HGST 2.5" 5400rpm 250GB HTS545025B9A300 Panther B SATA LF F/ W:C60F Disk imbalance criteria = 0.014g-cm	KH.25007.016
HGST	N320GB5.4KS	HDD HGST 2.5" 5400rpm 320GB HTS545032B9A300 Panther B SATA LF F/ W:C60F Disk imbalance criteria = 0.014g-cm	KH.32007.008
HGST	N320GB5.4KS	HDD HGST 2.5" 5400rpm 320GB HTS543232L9A300 Falcon B SATA LF F/ W:C40C Disk imbalance criteria = 0.014g-cm	KH.32007.009
HGST	N500GB5.4KS	HDD HGST 2.5" 5400rpm 500GB HTS545050B9A300 Panther B SATA LF F/ W:C60F Disk imbalance criteria = 0.014g-cm	KH.50007.010
SEAGATE	N160GB5.4KS	HDD SEAGATE 2.5" 5400rpm 160GB ST9160314AS Wyatt SATA LF F/W:0001SDM1	KH.16001.042
SEAGATE	N250GB5.4KS	HDD SEAGATE 2.5" 5400rpm 250GB ST9250315AS Wyatt SATA LF F/W:0001SDM1	KH.25001.016
SEAGATE	N320GB5.4KS	HDD SEAGATE 2.5" 5400rpm 320GB ST9320325AS Wyatt SATA LF F/W:0001SDM1	KH.32001.017
SEAGATE	N500GB5.4KS	HDD SEAGATE 2.5" 5400rpm 500GB ST9500325AS Wyatt SATA LF F/W:0001SDM1	KH.50001.011
TOSHIBA	N160GB5.4KS	HDD TOSHIBA 2.5" 5400rpm 160GB MK1665GSX, Capricorn BS, 320G/P SATA 8MB LF F/W:GJ002J	KH.16004.008
TOSHIBA	N250GB5.4KS	HDD TOSHIBA 2.5" 5400rpm 250GB MK2565GSX, Capricorn BS, 320G/P SATA 8MB LF F/W:GJ002J	KH.25004.005
TOSHIBA	N320GB5.4KS	HDD TOSHIBA 2.5" 5400rpm 320GB Capricorn BS ,MK3265GSX SATA 8MB LF F/ W:GJ002J	KH.32004.004
TOSHIBA	N500GB5.4KS	HDD TOSHIBA 2.5" 5400rpm 500GB MK5065GSX,Capricorn BS, 320G/P SATA 8MB LF F/W:GJ002J	KH.50004.002
WD	N160GB5.4KS	HDD WD 2.5" 5400rpm 160GB WD1600BEVT- 22A23T0 , WD, ML320S SATA 8MB LF F/ W:01.01A01	KH.16008.027

Vendor	Type	Description	P/N
WD	N250GB5.4KS	HDD WD 2.5" 5400rpm 250GB WD2500BEVT-22A23T0, WD, ML320S SATA 8MB LF F/ W:01.01A01.	KH.25008.025
WD	N320GB5.4KS	HDD WD 2.5" 5400rpm 320GB WD3200BEVT-22A23T0,ML320S,WD SATA 8MB LF F/ W:01.01A01	KH.32008.019
WD	N320GB5.4KS_4K	HDD WD 2.5" 5400rpm 320GB WD3200BPVT-22ZEST0, ML320S, 4K drive SATA 8MB LF F/ W: 01.01A01	KH.32008.022
WD	N500GB5.4KS	HDD WD 2.5" 5400rpm 500GB WD5000BEVT-22A0RT0, ML320M,WD SATA 8MB LF F/ W:01.01A01	KH.50008.017
WD	N640GB5.4KS	HDD WD 2.5" 5400rpm 640GB WD6400BEVT-22A0RT0, ML320 SATA 8MB LF F/ W:01.01A01	KH.64008.004
WD	N750GB5.4KS	HDD WD 2.5" 5400rpm 750GB WD7500BPVT-22HXZT1, ML375M, 4K drive SATA 8MB LF F/ W:01.01A01	KH.75008.009
Adapter			
DELTA	120W-DE	Adapter DELTA 120W-DE 19V 1.7x5.5x11 Green ADP-120ZB BBGB, LV5+OBL LED LF	AP.12001.009
LITE-ON	120W-DE	Adapter LITE-ON 120W-DE 19V 1.7x5.5x11 Green PA-1121-04AC, LV5+OBL LED LF	AP.12003.003
Audio Codec			
Realtek	ALC669X	Realtek ALC669X	LZ.21000.060
Battery			
PANASONIC	8CELL3.0	Battery PANASONIC AS10C Li-Ion 4S2P PANASONIC 8 cell 6000mAh Main COMMON ID:AS10C5E	BT.00805.015
SIMPLO	8CELL3.0	Battery SIMPLO AS10C Li-Ion 4S2P SAMSUNG 8 cell 6000mAh Main COMMON ID:AS10C7E	BT.00807.028
Bluetooth			
Foxconn	BT 3.0	Foxconn Bluetooth ATH AR3011 (BT3.0)	BH.21100.009
Foxconn	BT 3.0	Foxconn Bluetooth BRM 2046 BT3.0 (T60H928.33) f/w:861	BH.21100.008
Camera			
Chicony	1.3M	Chicony 1.3M CH9665SN (CNF9157)	AM.21400.067
Liteon	1.3M	Liteon 1.3M LT9665AL (09P2SF119)	AM.21400.069
Liteon	1.3M	Liteon 1.3M LT6AASP(09P2BF127)	AM.21400.070
Suyin	1.3M	Suyin 1.3M SY9665SN	AM.21400.068
Card Reader			
	5 in 1-Build in	5 in 1-Build in MS, MS Pro, SD, SC, XD	CR.21500.013
CPU			
INTEL	Ci3330M	CPU Intel Core i3 330M PGA 2.13G 35W Arrandale, TJ90, VT, 3M L3	KC.33001.DMP
INTEL	Ci3350M	CPU Intel Core i3 350M PGA 2.26G 35W Arrandale, TJ90, VT, 3M L3	KC.35001.DMP

Vendor	Type	Description	P/N
INTEL	Ci3350M	CPU Intel Core i3 350M PGA 2.26G 35W K-0 TJ90, VT	KC.35K01.DMP
INTEL	Ci3370M	CPU Intel Core i3 370M PGA 2.4G 35W K-0 TJ90, VT	KC.37K01.DMP
INTEL	Ci5430M	CPU Intel Core i5 430M PGA 2.26G ARD, up to SC 2.53G, 3M L3	KC.43001.DMP
INTEL	Ci5450M	CPU Intel Core i5 450M PGA 2.4G 35W K-0 up to SC 2.66G	KC.45K01.DMP
INTEL	Ci5460M	CPU Intel Core i5 460M PGA 2.53G 35W K-0	KC.46K01.DMP
INTEL	Ci5520M	CPU Intel Core i5 520M 2.4G	KC.52001.DMP
INTEL	Ci5540M	CPU Intel Core i5 540M 2.53G 3M	KC.54001.DMP
INTEL	Ci5560M	CPU Intel Core i5 560M PGA 2.66G 35W K-0 Turbo Boost 3.20/2.93	KC.56K01.DMP
INTEL	Ci7620M	CPU Intel Core i7 620M PGA 2.66G	KC.62001.DMP
INTEL	Ci7640M	CPU Intel Core i7 640M PGA 2.8G 35W K-0 Max DDR3-1066	KC.64K01.DMP
INTEL	Ci7720QM	CPU Intel Core i7 720QM PGA 1.6G 6M 45W	KC.72001.QMP
INTEL	Ci7740QM	CPU Intel Core i7 740QM PGA 1.73G 6M 45W	KC.74001.QMP
INTEL	Ci7820QM	CPU Intel Core i7 820QM 1.73G 1333 45W	KC.82001.QMP
Finger Print			
LTT	SS801U	LTT Finger Print SS801U	FP.22000.007
HDD			
TOSHIBA	N640GB5.4KS	HDD TOSHIBA 2.5" 5400rpm 640GB MK6465GSX,Capricorn BS,320G/P SATA 8MB LF F/W:GJ002J	KH.64004.001
Keyboard			
ACER	AF7P_A10S	Keyboard ACER AF7P_A10S AF7P Internal 17 Standard Silver NONE Y2010 Acer Legend Painting	KB.I170A.145
LAN			
Atheros	AR8151L	Atheros AR8151L	NI.22400.048
LCD			
CMO	NLED18.4WUX GAGL	LED LCD CMO 18.4" WUXGA Glare N184H6-L02 LF 220nit 8ms 500:1	LK.1840D.003
MEM			
ELPIDA	SO1GBIII10	Memory ELPIDA SO-DIMM DDRIII 1066 1GB EBJ10UE8BDS0-AE-F LF 128*8 0.065um	KN.1GB09.012
ELPIDA	SO2GBIII10	Memory ELPIDA SO-DIMM DDRIII 1066 2GB EBJ21UE8BDS0-AE-F LF 128*8 0.065um	KN.2GB09.006
HYNIX	SO1GBIII10	Memory HYNIX SO-DIMM DDRIII 1066 1GB HMT112S6BFR6C-G7 N0 LF 64*16 0.055um	KN.1GB0G.025
HYNIX	SO1GBIII13	Memory HYNIX SO-DIMM DDRIII 1333 1GB HMT112S6TFR8C-H9 LF 128*8 0.055um	KN.1GB0G.026
HYNIX	SO2GBIII10	Memory HYNIX SO-DIMM DDRIII 1066 2GB HMT125S6BFR8C-G7 N0 LF 128*8 0.055um	KN.2GB0G.014
HYNIX	SO2GBIII13	Memory HYNIX SO-DIMM DDRIII 1333 2GB HMT125S6TFR8C-H9 LF 128*8 0.055um	KN.2GB0G.016

Vendor	Type	Description	P/N
NONE	SO4GBIII10	Memory NONE SO-DIMM DDRIII 1066 4GB dummy P/N LF	KN.4GB00.001
SAMSUNG	SO1GBIII10	Memory SAMSUNG SO-DIMM DDRIII 1066 1GB M471B2873EH1-CF8 LF 64*16 0.055um	KN.1GB0B.028
SAMSUNG	SO2GBIII10	Memory SAMSUNG SO-DIMM DDRIII 1066 2GB M471B5673EH1-CF8 LF 128*8 0.055um	KN.2GB0B.012
NB Chipset			
INTEL	HM55	NB Chipset Intel CS BD82HM55	KI.G5501.002
ODD			
HLDS	NBDCB4XS	ODD HLDS BD COMBO 12.7mm Tray DL 4X CT21N LF W/O bezel 1.00 SATA (HF + Windows 7)	KO.0040D.004
HLDS	NSM8XS	ODD HLDS Super-Multi DRIVE 12.7mm Tray DL 8X GT30N LF W/O bezel SATA (HF + Windows 7)	KU.0080D.048
HLDS	NSM8XS	ODD HLDS Super-Multi DRIVE 12.7mm Tray DL 8X GT31N (R5-1) LF W/O bezel SATA with Renesas Solution (HF + Windows 7)	KU.0080D.054
PANASONIC	NBDRW4XS	ODD PANASONIC BD RW 12.7mm Tray DL 4X UJ240A LF W/O bezel SATA (HF+Windows 7)	KU.00407.015
PANASONIC	NBDRW4XS	ODD PANASONIC BD RW 12.7mm Tray DL 4X UJ230A LF W/O bezel FW 1.10 SATA (Windows 7)	KU.00407.014
PANASONIC	NSM8XS	ODD PANASONIC Super-Multi DRIVE 12.7mm Tray DL 8X UJ890A LF W/O bezel SATA (HF + Windows 7)	KU.00807.070
PANASONIC	NSM8XS	ODD PANASONIC Super-Multi DRIVE 12.7mm Tray DL 8X UJ8A0 LF W/O bezel SATA (HF + Windows 7) Foxconn Yentai Facotry	KU.00807.075
PLDS	NBDCB4XS	ODD PLDS BD COMBO 12.7mm Tray DL 4X DS-4E1S LF W/O bezel SATA (Windows 7)	KO.0040F.003
PLDS	NSM8XS	ODD PLDS Super-Multi DRIVE 12.7mm Tray DL 8X DS-8A4SH LF W/O bezel SATA (HF + Windows 7)	KU.0080F.006
SONY	NBDCB4XS	ODD SONY BD COMBO 12.7mm Tray DL 4X BC-5500H LF W/O bezel SATA (HF + Windows 7)	KO.0040E.003
SONY	NBDRW4XS	ODD SONY BD RW 12.7mm Tray 4X BD-5730H-AR LF+HF W/O bezel SATA Supporting Windows 7 + Vista	KU.0040E.001
SONY	NSM8XS	ODD SONY Super-Multi DRIVE 12.7mm Tray DL 8X AD-7585H LF W/O bezel SATA (HF + Windows 7)	KU.0080E.027
TOSHIBA	NSM8XS	ODD TOSHIBA Super-Multi DRIVE 12.7mm Tray DL 8X TS-L633C LF W/O bezel SATA (HF + Windows 7)	KU.00801.035
Remote Controller			
Fomosa21	RC804V-B	Fomosa21 Remote Controller RC804V-B EU	RT.22700.008
Formosa21	RC804V-B	Formosa21 Remote Controller RC804V-B TC	RT.22700.009
Formosa21	RC804V-B	Formosa21 Remote Controller RC804V-B SC	RT.22700.010

Vendor	Type	Description	P/N
Formosa21	RC804V-B	Formosa21 Remote Controller RC804V-B EN	RT.22700.011
SB Chipset			
None	N	N	KI.22800.011
Software			
	McAfee	Antivirus application McAfee	SR.23900.001
TV Antenna			
	Passive Antenna	Avermedia Di-Pole passive TV Antenna	LZ.23000.004
TV Tuner			
	DVB-T Mini-card	DVB-T Mini-card TT-1260DA w/DiBCOM DIB7070P+DiB0700C rev.D	TU.23100.015
	DVB-T Mini-card	DVB-T Mini-card TT-1280DA w/DiBCOM DIB7770 Half-size minicard	TU.23100.024
VGA Chip			
AMD	BROADWAY_PRO	VGA Chip AMD BROADWAY_PRO 100-CK3623 40nm 29mm*29mm M2 package	KI.23200.172
AMD	MADISON_PRO	VGA Chip AMD MADISON_PRO 100-CK3625 40nm 29mm*29mm M2 package	KI.23200.169
VRAM			
	1G-DDR3 (64*16*8)	1G-DDR3 64*16*8	KI.23300.018
	2G-DDR3 (128*16*8)	2G-DDR3 128*16*8	KI.23300.028
WiFi Antenna			
WNC	PIFA	PIFA	LZ.23500.006
Wireless LAN			
Foxconn	3rd WiFi 2x2 BGN	Foxconn Wireless LAN Atheros HB93 2x2 BGN (HM)	NI.23600.062
Foxconn	3rd WiFi 2x2 BGN	Foxconn Wireless LAN Broadcomm 43225 2x2 BGN (HM) T77H103.00	NI.23600.066
Foxconn	3rd WiFi 2x2 BGN	Foxconn Wireless LAN Atheros HB97 2x2 BGN (HM)	NI.23600.072
Foxconn	3rd WiFi BG	Foxconn Wireless LAN Broadcom 4312H BG (HM)	NI.23600.053
Foxconn	3rd WiFi BG	Foxconn Wireless LAN Atheros HB95BG (HM) T77H121.10	NI.23600.077

Online Support Information

This section describes online technical support services available to help you repair your Acer Systems.

If you are a distributor, dealer, ASP or TPM, please refer your technical queries to your local Acer branch office. Acer Branch Offices and Regional Business Units may access our website. However some information sources will require a user i.d. and password. These can be obtained directly from Acer CSD Taiwan.

Acer's Website offers you convenient and valuable support resources whenever you need them.

In the Technical Information section you can download information on all of Acer's Notebook, Desktop and Server models including:

- Service guides for all models
- BIOS updates
- Software utilities
- Spare parts lists
- TABs (Technical Announcement Bulletin)

For these purposes, we have included an Acrobat File to facilitate the problem-free downloading of our technical material.

Also contained on this website are:

- Detailed information on Acer's International Traveler's Warranty (ITW)
- Returned material authorization procedures
- An overview of all the support services we offer, accompanied by a list of telephone, fax and email contacts for all your technical queries.

We are always looking for ways to optimize and improve our services, so if you have any suggestions or comments, please do not hesitate to communicate these to us.

A

- Antennas
 - Removing 113

B

- Battery Pack
 - Removing 50
- BIOS
 - ROM type 22
 - vendor 22
- BIOS Utility 31–39
 - Advanced 34
 - Boot 37
 - Exit 38
 - Navigating 31
 - Power 37
 - Save and Exit 38
 - Security 34
 - System Security 38
- brightness
 - hotkeys 15

C

- Camera Board
 - Removing 99, 103, 118
- Common Problems 172
- CPU
 - Replacing 131, 132
- CRT Cable
 - Removing 84, 90, 95

D

- DIMM Module
 - Removing 55
- Display 6
- display
 - hotkeys 15

E

- Euro Key 16
- External Module Disassembly
 - Flowchart 48

F

- Features 1

- FLASH Utility 39
- Flash Utility 39
- FRU (Field Replaceable Unit) List 193

H

- Hard Disk Drive Module
 - Removing 53
- Hibernation mode
 - hotkey 15
- Hot Keys 13

I

- Indicators 11
- Intermittent Problems 182
- Internal Microphone Failure 179
- Internal Speaker Failure 178

J

- Jumper and Connector Locations 189

K

- Keyboard
 - Removing 63
- Keyboard Failure 176

L

- LCD Bezel
 - Removing 101, 120
- LCD Failure 175
- LCD Module
 - Removing 151
- LCD Module Disassembly
 - Flowchart 98
- LCD Panel
 - Removing 104, 118

M

- Main Unit Disassembly
 - Flowchart 65
- Mainboard
 - Removing 84, 90, 95
- Memory Check 172
- Microphone
 - Removing 104, 118

Model Definition 209

N

No Display Issue 173

O

ODD Failure 181

Online Support Information 349

P

Panel 7

PC Card 11

Power On Failure 172

S

Speaker Module
Removing 72

speakers
hotkey 15

System
Block Diagram 6

T

Test Compatible Components 343

Thermal Module
Removing 86

Touch Pad Failure 177

TouchPad FFC
Removing 74, 75, 77, 79, 81

Troubleshooting
Built-in KB Failure 176
Internal Microphone 179
Internal Speakers 178
LCD Failure 175
No Display 173
ODD 181
Other Failures 181
Power On 172
Touch Pad 177
USB 181

U

Undetermined Problems 182

Upper Cover
Removing 66

USB Failure (Rightside) 181

utility
BIOS 31–39

W

Windows 2000 Environment Test 343

WLAN Board
Removing 56, 57